

# MBM250H33E3

Silicon N-channel IGBT 3300V E3 version

## FEATURES

- \* Soft switching behavior & low conduction loss:  
Soft low-injection punch-through High conductivity IGBT.
- \* Low driving power due to low input capacitance MOS gate.
- \* Low noise recovery: Ultra soft fast recovery diode.

## ABSOLUTE MAXIMUM RATINGS (T<sub>c</sub>=25°C )

Item	Symbol	Unit	MBM250H33E3
Collector Emitter Voltage	V <sub>CES</sub>	V	3,300
Gate Emitter Voltage	V <sub>GES</sub>	V	±20
Collector Current	DC	I <sub>c</sub>	250 (T <sub>c</sub> =95 °C)
	1ms	I <sub>cp</sub>	
Forward Current	DC	I <sub>F</sub>	250
	1ms	I <sub>FM</sub>	500
Peak Forward Surge Current	I <sub>FSM</sub>	A <sub>p</sub>	2000
Total Power Dissipation	P <sub>tot</sub>	W	2500 (T <sub>c</sub> =25°C per IGBT)
Junction Temperature	T <sub>j</sub>	°C	-40 ~ +150
Junction Operating Temperature	T <sub>jop</sub>	°C	-40 ~ +125
Case Temperature	T <sub>c</sub>	°C	-40 ~ +125
Storage Temperature	T <sub>stg</sub>	°C	-50 ~ +125
Isolation Voltage	V <sub>ISO</sub>	V <sub>RMS</sub>	7,700 (AC 1 minute)
Screw Torque	Mounting (M6)	-	6 (1)

Notes: (1) Recommended Value 5.5±0.5N·m

- \* Please contact our representatives at order.
- \* For improvement, specifications are subject to change without notice.
- \* For actual application, please confirm this spec sheet is the newest revision.

# MBM250H33E3

## ELECTRICAL CHARACTERISTICS (IGBT)

Item	Symbol	Unit	Min.	Typ.	Max.	Test Conditions		
Collector Emitter Cut-Off Current	$I_{CES}$	mA	-	-	2	$T_j=25^\circ\text{C}$	$V_{CE}=3,300\text{V}, V_{GE}=0\text{V}$	
			-	4	10	$T_j=125^\circ\text{C}$		
Gate Emitter Leakage Current	$I_{GES}$	nA	-500	-	+500	$V_{GE}=\pm 20\text{V}, V_{CE}=0\text{V}, T_j=25^\circ\text{C}$		
Collector Emitter Saturation Voltage	$V_{CE(sat)}$	V	-	2.65	-	$T_j=25^\circ\text{C}$	$I_C=250\text{A}, V_{GE}=15\text{V}$	
			2.70	3.40	3.90	$T_j=125^\circ\text{C}$		
			-	3.60	-	$T_j=150^\circ\text{C}$		
Gate Emitter Threshold Voltage	$V_{GE(TH)}$	V	5.5	6.3	7.5	$V_{CE}=10\text{V}, I_C=250\text{mA}, T_j=25^\circ\text{C}$		
Gate Charge	$Q_g$	$\mu\text{C}$	-	2.8	-	$V_{CC}=2800\text{V}, I_C=250\text{A}, V_{GE}=\pm 15\text{V}$		
Input Capacitance	$C_{ies}$	nF	-	33	-	$V_{CE}=10\text{V}, V_{GE}=0\text{V}, f=100\text{kHz}, T_j=25^\circ\text{C}$		
Output Capacitance	$C_{oes}$	nF	-	3.3	-			
Reverse transfer capacitance	$C_{res}$	nF	-	2.3	-			
Internal Gate Resistance	$R_{ge}$	$\Omega$	-	5.4	-	$V_{CE}=10\text{V}, V_{GE}=0\text{V}, f=100\text{kHz}, T_j=25^\circ\text{C}$		
Switching Times	Rise Time	$t_r$	$\mu\text{s}$	-	1.5	-	$T_j=25^\circ\text{C}$	$V_{CC}=1,800\text{V}, I_C=250\text{A}, L_s=400\text{nH}, R_G=15\Omega (2), V_{GE}=\pm 15\text{V}$
				-	1.8	2.5	$T_j=125^\circ\text{C}$	
				-	1.9	-	$T_j=150^\circ\text{C}$	
	Turn On Time	$t_{on}$		-	2.1	-	$T_j=25^\circ\text{C}$	
				-	2.5	3.3	$T_j=125^\circ\text{C}$	
				-	2.5	-	$T_j=150^\circ\text{C}$	
	Fall Time	$t_f$		-	1.6	-	$T_j=25^\circ\text{C}$	
				-	1.9	3.2	$T_j=125^\circ\text{C}$	
				-	1.9	-	$T_j=150^\circ\text{C}$	
	Turn Off Time	$t_{off}$		-	3.6	-	$T_j=25^\circ\text{C}$	
				-	4.0	5.2	$T_j=125^\circ\text{C}$	
				-	4.0	-	$T_j=150^\circ\text{C}$	
Turn On Loss	$E_{on(full)}$	J/p	-	0.35	-	$T_j=25^\circ\text{C}$	$V_{CC}=1800\text{V}, I_C=250\text{A}, L_s=400\text{nH}, R_G=15\Omega (2), V_{GE}=\pm 15\text{V}$	
	$E_{on(10\%)}$		-	0.43	0.58	$T_j=125^\circ\text{C}$		
	$E_{on(full)}$		-	0.48	-	$T_j=125^\circ\text{C}$		
Turn Off Loss	$E_{off(full)}$	-	0.50	-	$T_j=150^\circ\text{C}$			
	$E_{off(full)}$	-	0.40	-	$T_j=25^\circ\text{C}$			
	$E_{off(10\%)}$	-	0.37	0.50	$T_j=125^\circ\text{C}$			
	$E_{off(full)}$	-	0.48	-	$T_j=125^\circ\text{C}$			
	$E_{off(full)}$	-	0.49	-	$T_j=150^\circ\text{C}$			

Notes:(2)  $R_G$  value is the test condition's value for evaluation of the switching times, not recommended value.  
Please, determine the suitable  $R_G$  value after the measurement of switching waveforms (overshoot voltage, etc.) with appliance mounted.

## ELECTRICAL CHARACTERISTICS (DIODE)

Item	Symbol	Unit	Min.	Typ.	Max.	Test Conditions	
Peak Forward Voltage Drop	$V_{FM}$	V	-	2.70	-	$T_j=25^\circ\text{C}$	$I_F=250\text{A}, V_{GE}=0\text{V}$
			2.30	2.90	3.30	$T_j=125^\circ\text{C}$	
			-	2.80	-	$T_j=150^\circ\text{C}$	
Reverse Recovery Time	$t_{rr}$	$\mu\text{s}$	-	0.50	-	$T_j=25^\circ\text{C}$	$V_{CC}=1800\text{V}, I_F=250\text{A}, L_s=400\text{nH}, R_G=15\Omega (3)$
			-	0.70	1.2	$T_j=125^\circ\text{C}$	
			-	0.80	-	$T_j=150^\circ\text{C}$	
Reverse Recovery Current	$I_{rr}$	A	-	270	-	$T_j=25^\circ\text{C}$	
			-	330	-	$T_j=125^\circ\text{C}$	
			-	330	-	$T_j=150^\circ\text{C}$	
Recovery charge	$Q_{rr}$	$\mu\text{C}$	-	70	-	$T_j=25^\circ\text{C}$	
			-	120	-	$T_j=125^\circ\text{C}$	
			-	120	-	$T_j=150^\circ\text{C}$	
Reverse Recovery Loss	$E_{rr(full)}$	J/p	-	0.21	-	$T_j=25^\circ\text{C}$	$V_{CC}=1800\text{V}, I_F=250\text{A}, L_s=400\text{nH}, R_G=15\Omega (3)$
	$E_{rr(10\%)}$		-	0.31	0.41	$T_j=125^\circ\text{C}$	
	$E_{rr(full)}$		-	0.40	-	$T_j=125^\circ\text{C}$	
	$E_{rr(full)}$		-	0.45	-	$T_j=150^\circ\text{C}$	

Notes:(3)  $R_G$  value is the test condition's value for evaluation of the switching times, not recommended value.  
Please, determine the suitable  $R_G$  value after the measurement of switching waveforms (overshoot voltage, etc.) with appliance mounted.

# MBM250H33E3

## THERMAL CHARACTERISTICS

Item	Symbol	Unit	Min.	Typ.	Max.	Test Conditions	
Thermal Impedance	IGBT	$R_{th(j-c)}$	K/W	-	-	0.050	Junction to case
	FWD	$R_{th(j-c)}$		-	-	0.100	
Contact Thermal Impedance		$R_{th(c-f)}$	K/W	-	0.032	-	Case to fin ( $\lambda_{grease}=1W/(m \cdot K)$ , heat-sink flatness $\leq 50\mu m$ )

## MODULE MECHANICAL CHARACTERISTICS

Item	Unit	Characteristics	Conditions	
Weight	g	840		
Creepage Distance	Between terminal	mm	54	Collector-sense to Emitter-main
	Terminal-Base	mm	64	
Clearance Distance	Between terminal	mm	19	Collector-sense to Emitter-main
	Terminal-Base	mm	35	
Stray inductance in module	LS(CM-EM)	nH	140	Between C1- E2
Resistance, Terminal-chip	$R_{CC'+EE'}$	m $\Omega$	1.5	Terminal to chip
Comparative Tracking Index (CTI)			600	
Module base plate Material			Cu	
Baseplate Thickness	mm		5	
Insulation plate Material			AlN	
Terminal Surface treatment			Ni plating	
Case Material			Poly-Phenilene Sulfide	

# MBM250H33E3

## DEFINITION OF TEST CIRCUIT

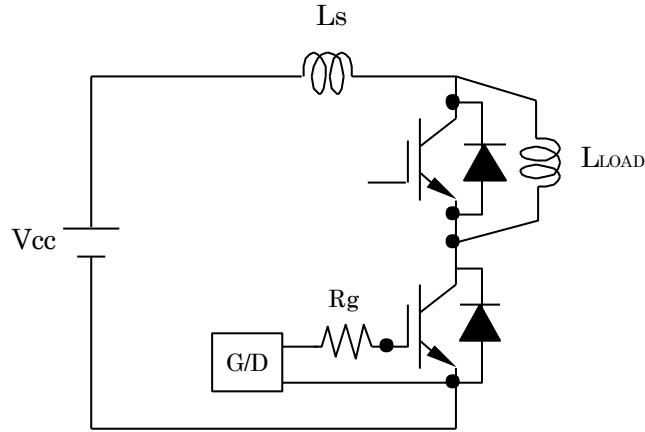

**Fig.1 Switching test circuit**

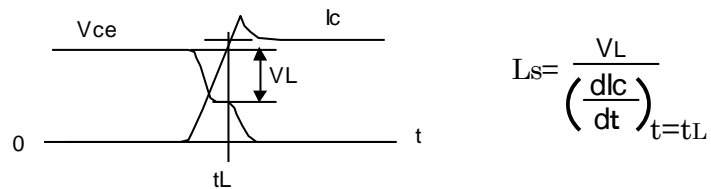

**Fig.2 Definition of Ls**

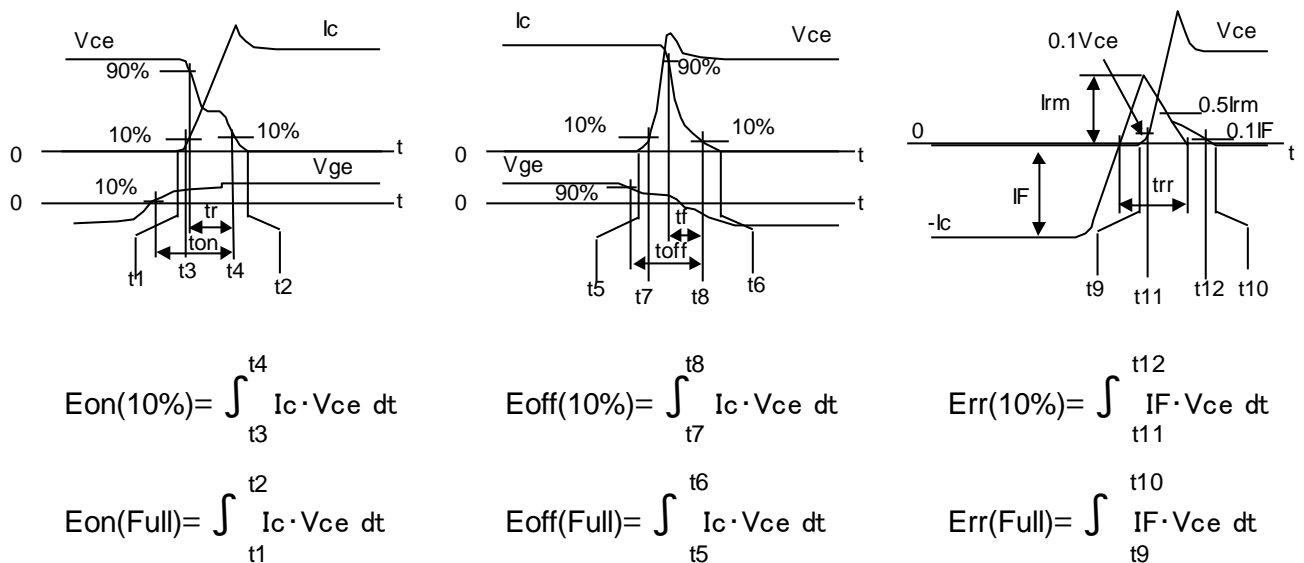

**Fig.3 Definition of switching loss**

# MBM250H33E3

## STATIC CHARACTERISTICS

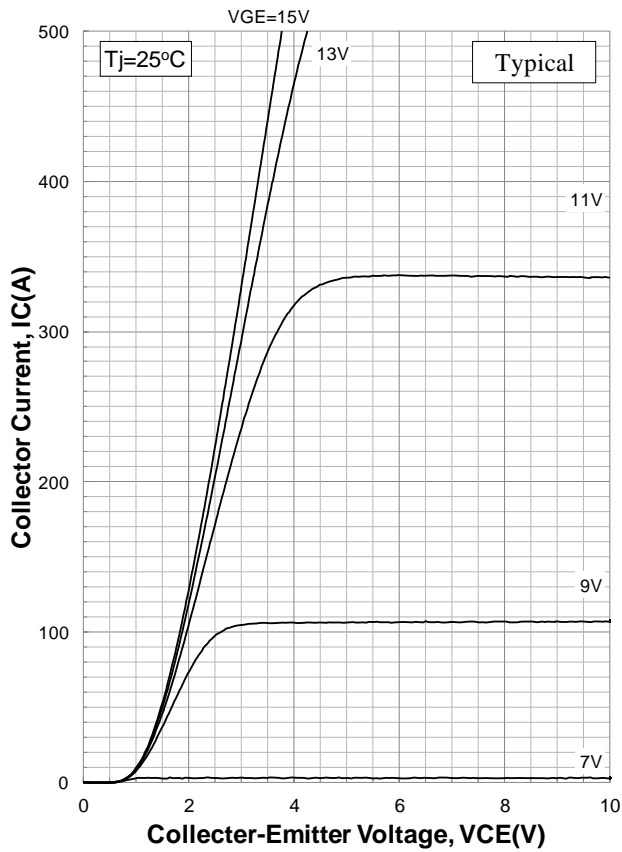

Collector Current vs. Collector to Emitter Voltage

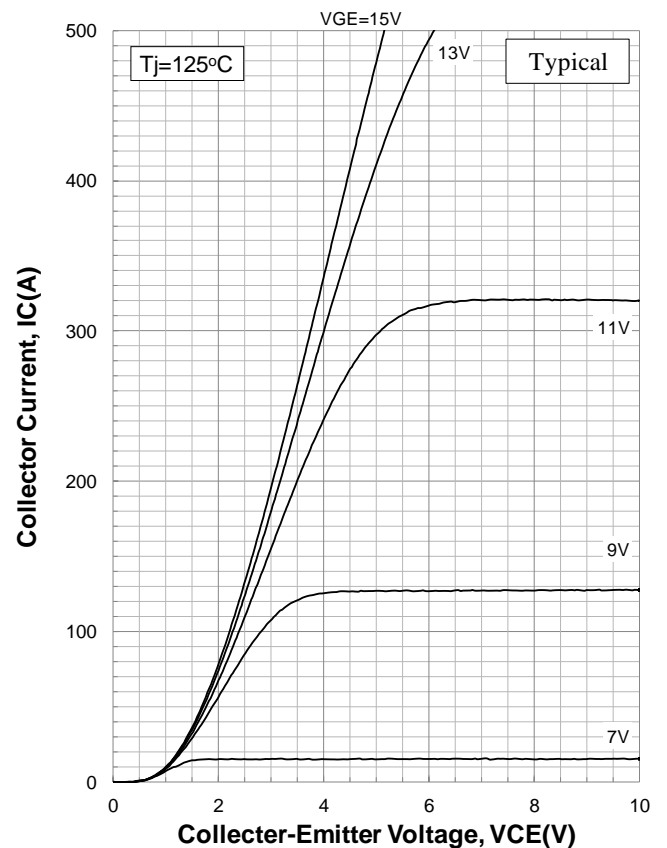

Collector Current vs. Collector to Emitter Voltage

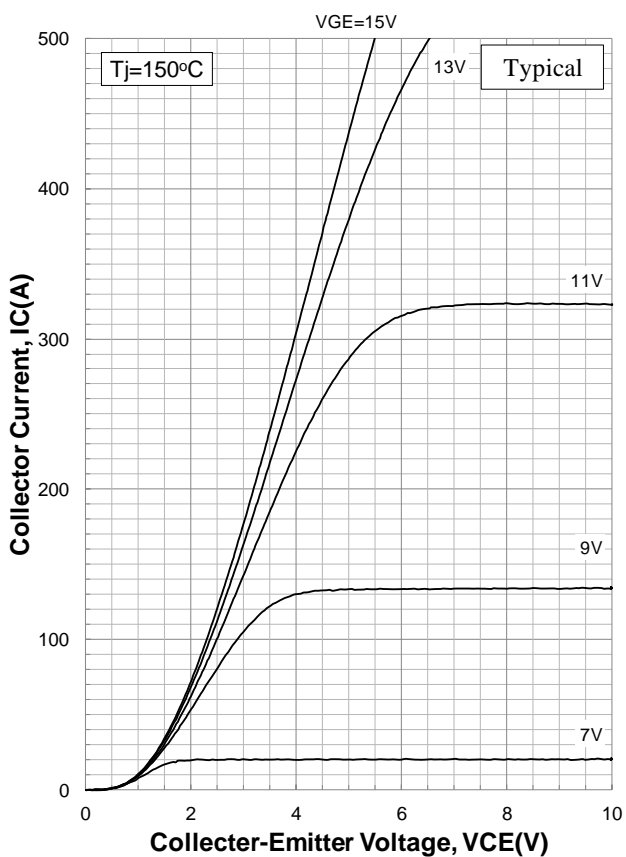

Collector Current vs. Collector to Emitter Voltage

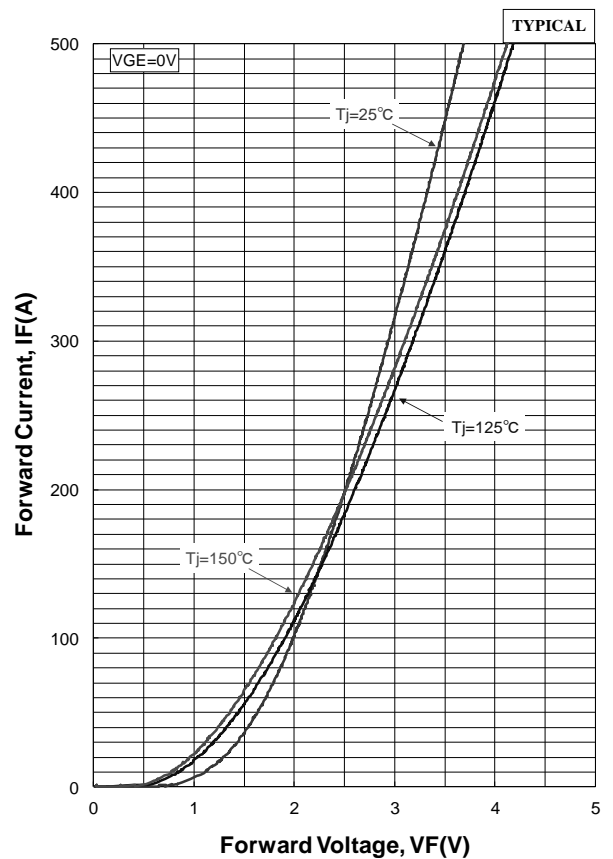

Forward Voltage of free-wheeling diode

# MBM250H33E3

## DYNAMIC CHARACTERISTICS

### DEPENDENCE OF CURRENT

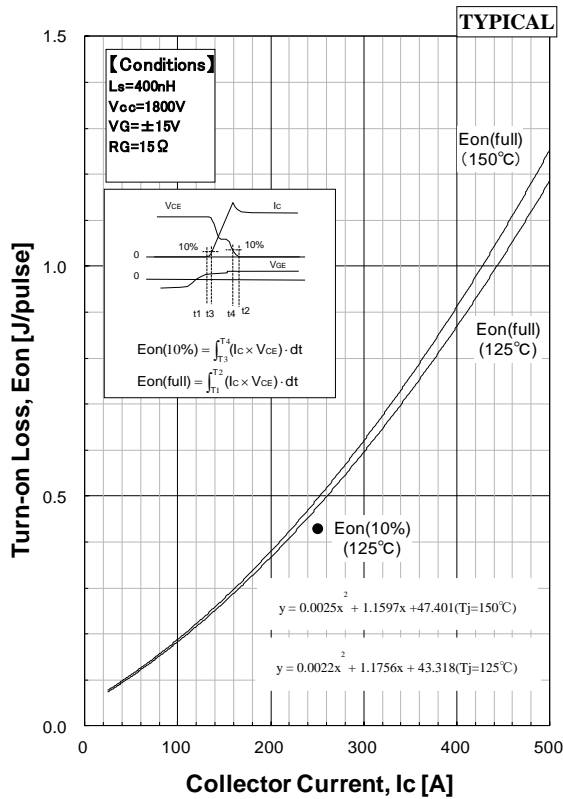

Turn-on Loss vs. Collector current

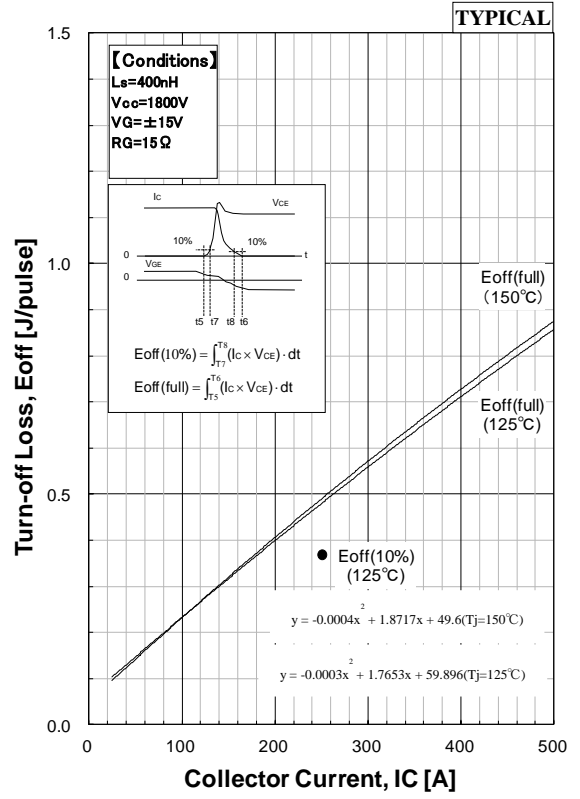

Turn-off Loss vs. Collector current

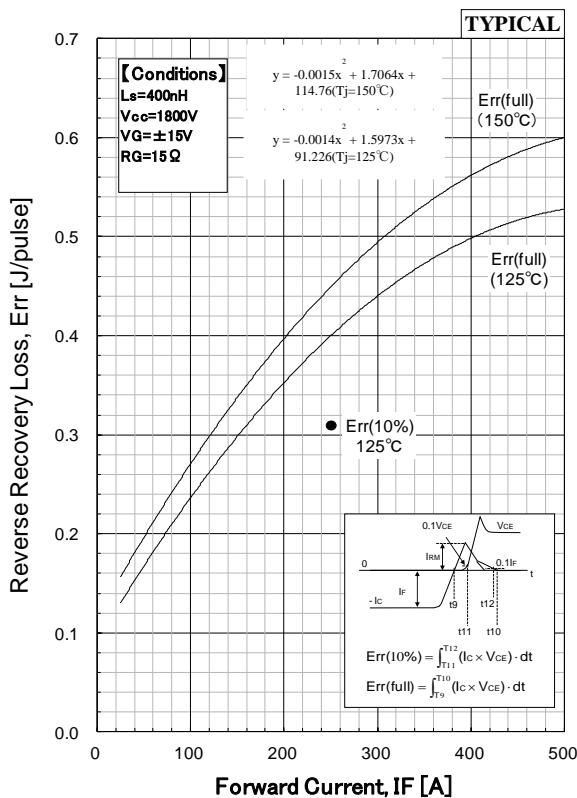

Recovery loss vs. Forward current

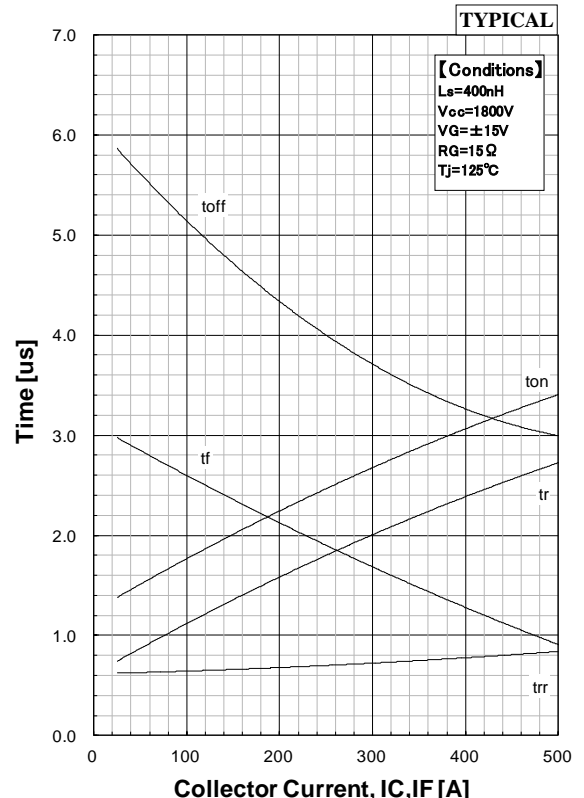

Switching time vs. Collector current

# MBM250H33E3

## DEPENDENCE OF RG

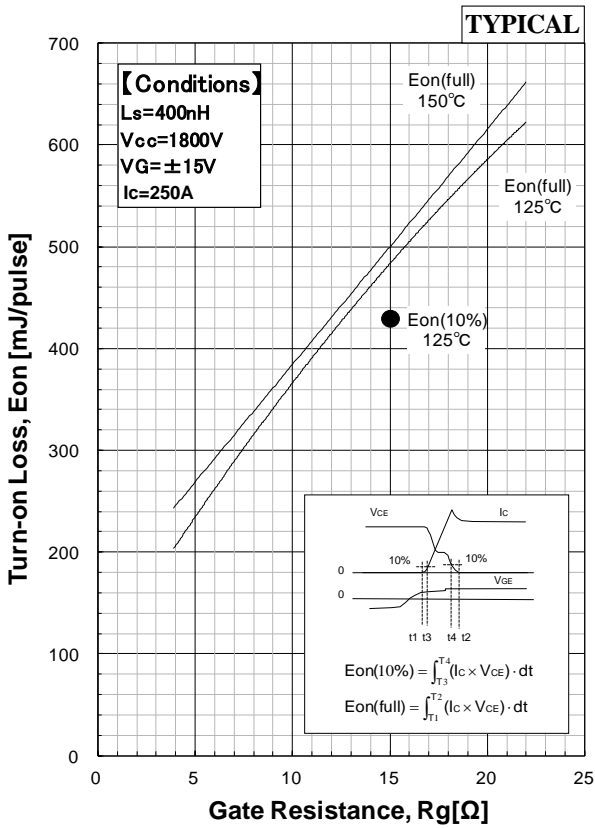

Turn-on Loss vs Gate Resistance

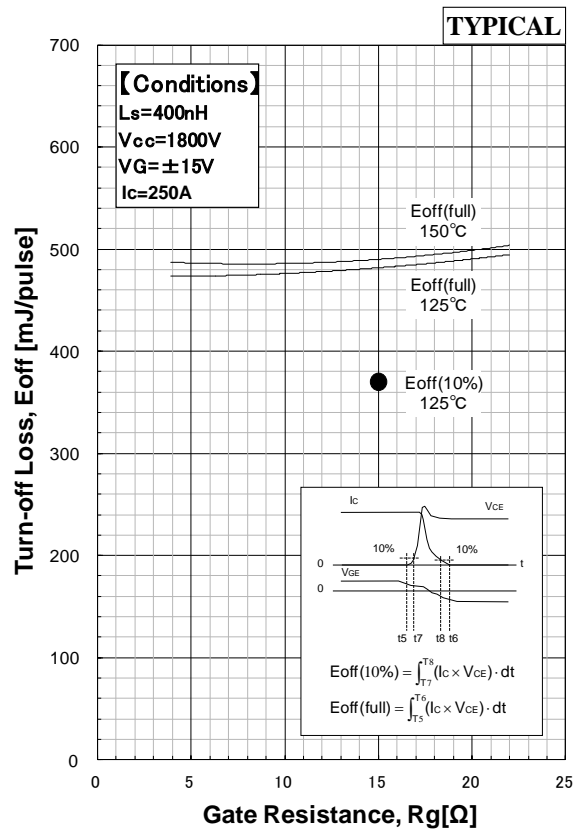

Turn-off Loss vs Gate Resistance

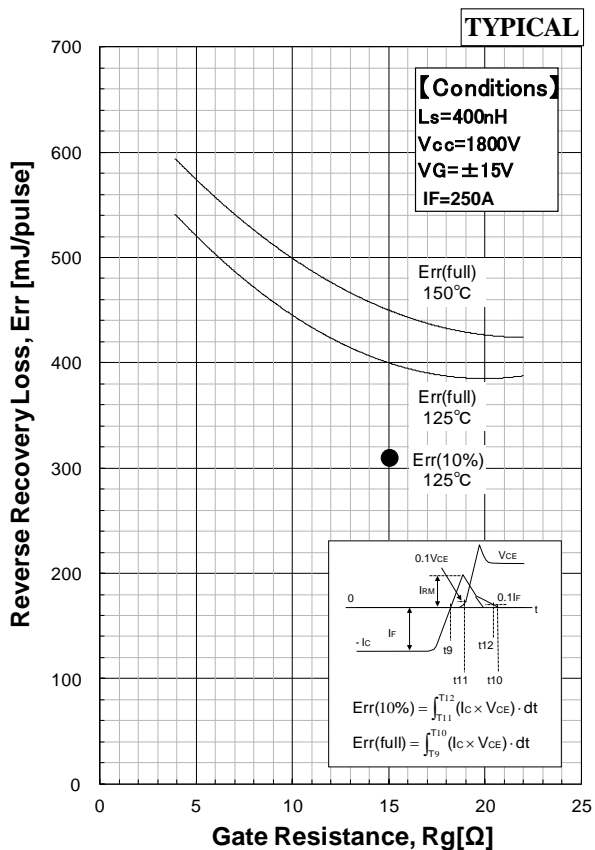

Recovery Loss vs Gate Resistance

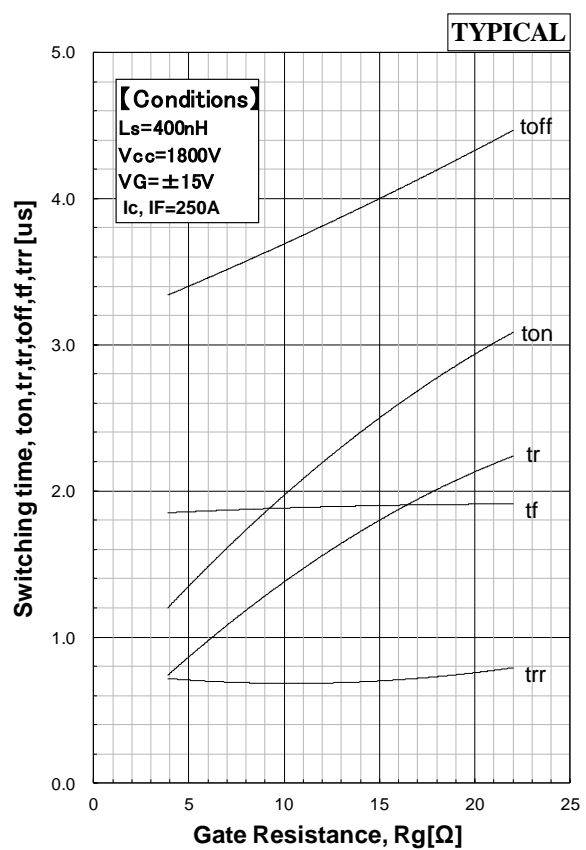

Switching time vs Gate Resistance

# MBM250H33E3

Cies, Coes, Cres-VCE, QG-VG

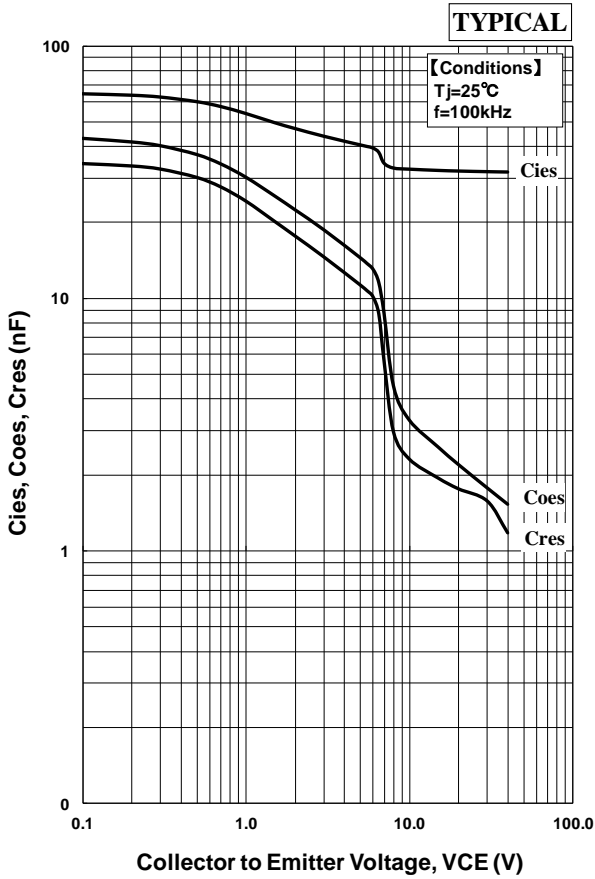

Cies, Coes, Cres-VCE

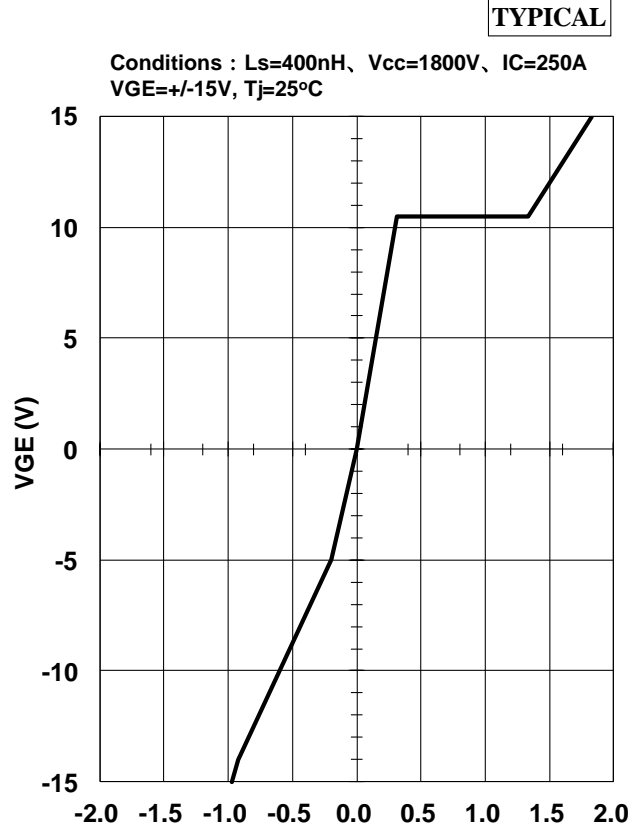

QG-VGE Curve

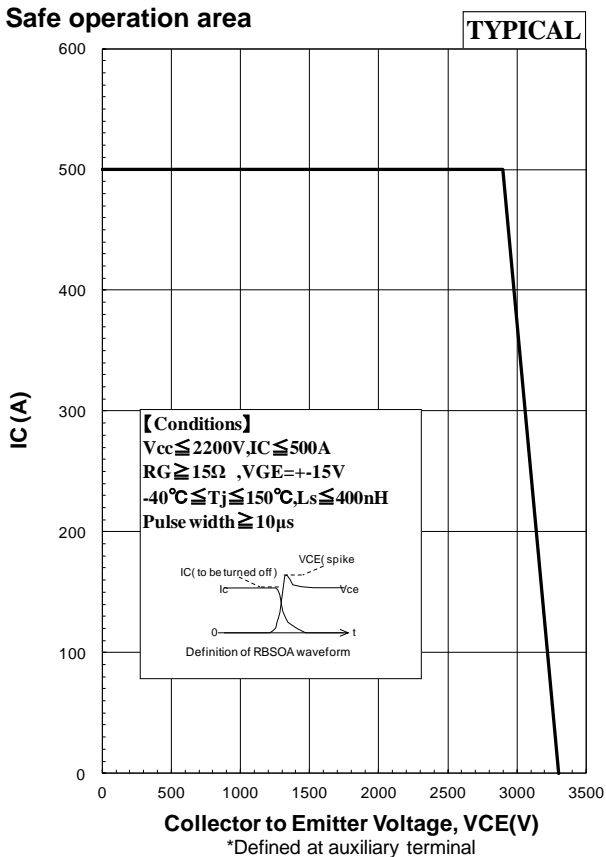

Reverse bias Safe operation area (RBSOA)

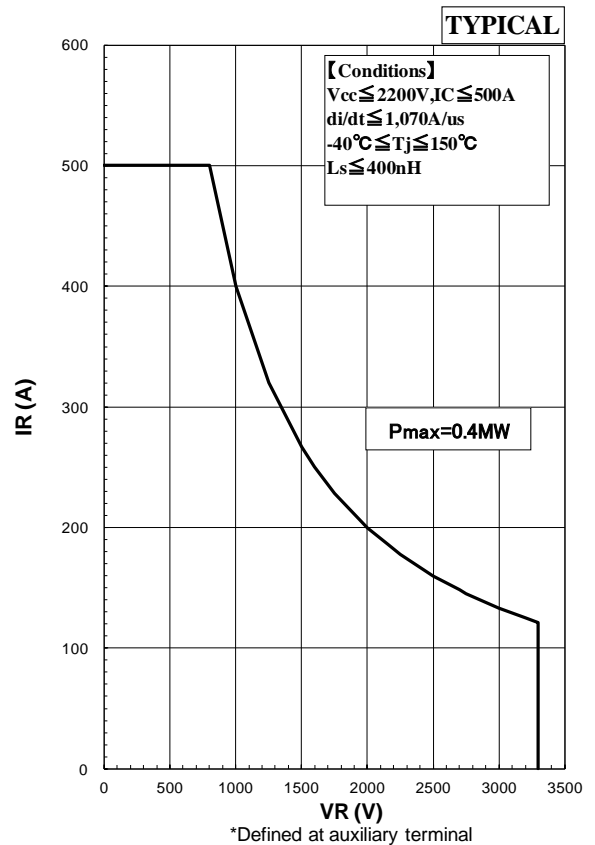

Reverse Recovery Safe operation area (RecSOA)



# MBM250H33E3

## TRANSIENT THERMAL IMPEDANCE

**Maximum**

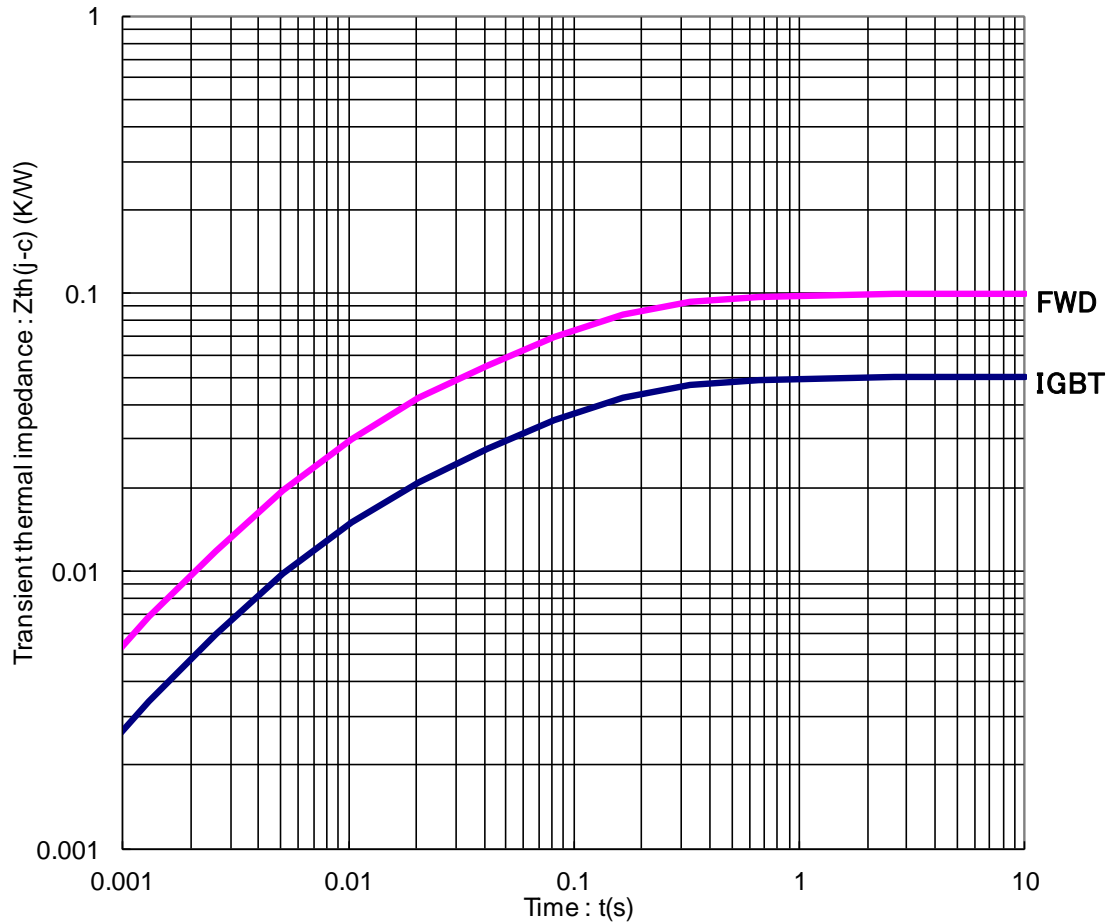

### Transient Thermal Impedance Curve

Curve approximation model  
 $Z_{th} = \sum r_{th}[n] * (1 - \exp(-t/\tau_{th}[n]))$

n	1	2	3	4	Unit
$\tau_{th}[n]$	2.73E-01	7.21E-02	8.98E-03	2.02E-03	sec
$r_{th}[n,IGBT]$	9.27E-03	2.52E-02	1.32E-02	2.35E-03	K/W
$r_{th}[n,Diode]$	1.83E-02	5.07E-02	2.61E-02	4.89E-03	K/W

### Material Declaration

Please note the following material is contained in the product in order to keep product characteristic and reliability level.

Material	Contained part
Lead (Pb) and its compounds	Solder

# MBM250H33E3

## Module Outline Drawing

Unit: mm

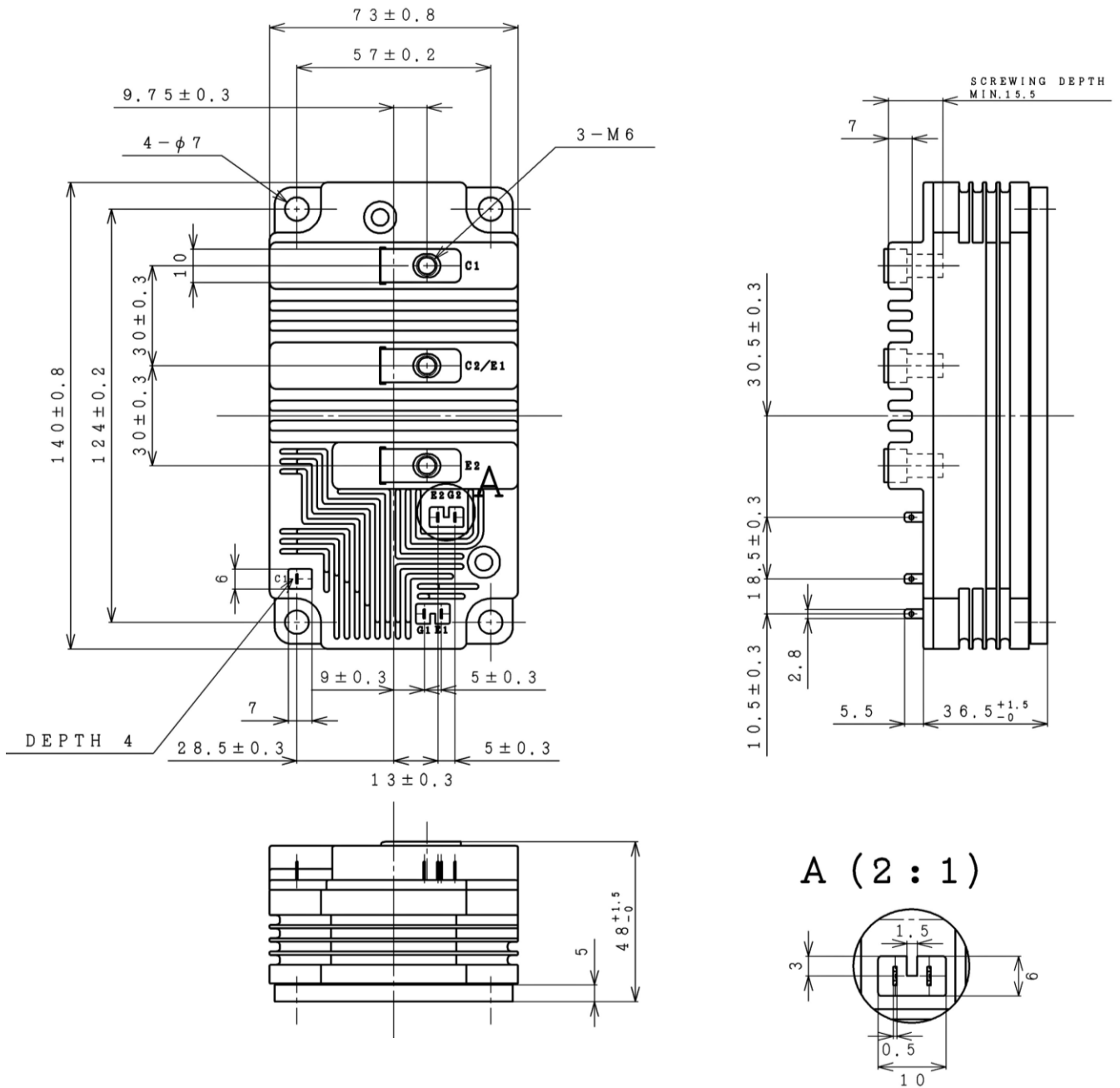

## CIRCUIT DIAGRAM

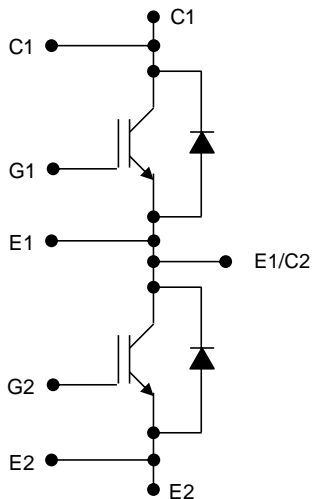

# MBM250H33E3

## HITACHI POWER SEMICONDUCTORS

### Notices

1. The information given herein, including the specifications and dimensions, is subject to change without prior notice to improve product characteristics. Before ordering, purchasers are advised to contact Hitachi sales department for the latest version of this data sheets.
2. Please be sure to read "Precautions for Safe Use and Notices" in the individual brochure before use.
3. In cases where extremely high reliability is required (such as use in nuclear power control, aerospace and aviation, traffic equipment, life-support-related medical equipment, fuel control equipment and various kinds of safety equipment), safety should be ensured by using semiconductor devices that feature assured safety or by means of users' fail-safe precautions or other arrangement. Or consult Hitachi's sales department staff.
4. In no event shall Hitachi be liable for any damages that may result from an accident or any other cause during operation of the user's units according to this data sheets. Hitachi assumes no responsibility for any intellectual property claims or any other problems that may result from applications of information, products or circuits described in this data sheets.
5. In no event shall Hitachi be liable for any failure in a semiconductor device or any secondary damage resulting from use at a value exceeding the absolute maximum rating.
6. No license is granted by this data sheets under any patents or other rights of any third party or Hitachi Power Semiconductor Device, Ltd.
7. This data sheets may not be reproduced or duplicated, in any form, in whole or in part, without the expressed written permission of Hitachi Power Semiconductor Device, Ltd.
8. The products (technologies) described in this data sheets are not to be provided to any party whose purpose in their application will hinder maintenance of international peace and safety not are they to be applied to that purpose by their direct purchasers or any third party. When exporting these products (technologies), the necessary procedures are to be taken in accordance with related laws and regulations.

- 
- For inquiries relating to the products, please contact nearest overseas representatives that is located "Inquiry" portion on the top page of a home page.
- 

Hitachi power semiconductor home page address <http://www.hitachi-power-semiconductor-device.co.jp/en/>