

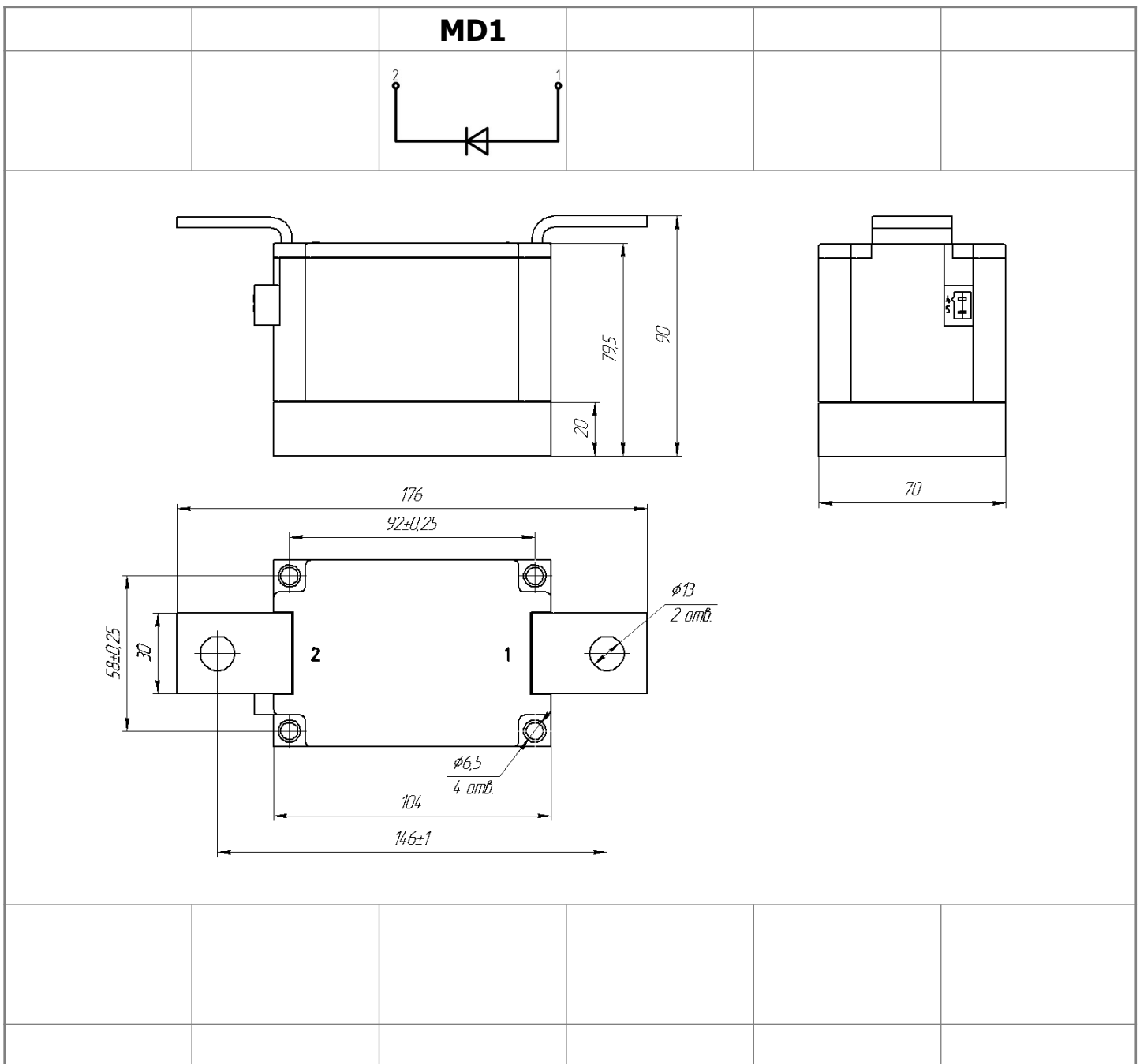

**Single Diode Module
For Phase Control
MD1-1125-28-E**

Electrically isolated base plate
Industrial standard package
Simplified mechanical design, rapid assembly
Pressure contact

Average forward current		I_{FAV}	1125 A
Repetitive peak reverse voltage		V_{RRM}	2400 ÷ 2800 V
V_{RRM}, V	2400	2600	2800
Voltage code	24	26	28
$T_j, ^\circ C$	- 40 ÷ 160		



All dimensions in millimeters (inches)

MAXIMUM ALLOWABLE RATINGS

Symbols and parameters		Units	Values	Test conditions
ON-STATE				
I_{FAV}	Average forward current	A	1125	$T_c = 100\text{ }^\circ\text{C}$; 180° half-sine wave; 50 Hz
I_{FRMS}	RMS forward current	A	1766	
I_{FSM}	Surge forward current	kA	36.0 43.0	$T_j = T_{j\text{ max}}$ $T_j = 25\text{ }^\circ\text{C}$ 180° half-sine wave; $t_p = 10\text{ ms}$; single pulse; $V_R = 0\text{ V}$;
			38.0 46.0	$T_j = T_{j\text{ max}}$ $T_j = 25\text{ }^\circ\text{C}$ 180° half-sine wave; $t_p = 8.3\text{ ms}$; single pulse; $V_R = 0\text{ V}$;
I^2t	Safety factor	$A^2s \cdot 10^3$	6400 9200	$T_j = T_{j\text{ max}}$ $T_j = 25\text{ }^\circ\text{C}$ 180° half-sine wave; $t_p = 10\text{ ms}$; single pulse; $V_R = 0\text{ V}$;
			5900 8700	$T_j = T_{j\text{ max}}$ $T_j = 25\text{ }^\circ\text{C}$ 180° half-sine wave; $t_p = 8.3\text{ ms}$; single pulse; $V_R = 0\text{ V}$;
BLOCKING				
V_{RRM}	Repetitive peak reverse voltages	V	2400÷2800	$T_{j\text{ min}} < T_j < T_{j\text{ max}}$; 180° half-sine wave; 50 Hz;
V_{RSM}	Non-repetitive peak reverse voltages	V	2500÷2900	$T_{j\text{ min}} < T_j < T_{j\text{ max}}$; 180° half-sine wave; single pulse;
V_R	Reverse continuous voltages	V	$0.6 \cdot V_{RRM}$	$T_j = T_{j\text{ max}}$;
THERMAL				
T_{stg}	Storage temperature	$^\circ\text{C}$	- 40 ÷ 50	
T_j	Operating junction temperature	$^\circ\text{C}$	- 40 ÷ 160	
$T_{c\text{ op}}$	Operating temperature	$^\circ\text{C}$	- 40 ÷ 125	
MECHANICAL				
a	Acceleration under vibration	m/s^2	50	

CHARACTERISTICS

Symbols and parameters		Units	Values	Conditions
ON-STATE				
V_{FM}	Peak forward voltage, max	V	1.38	$T_j = 25\text{ }^\circ\text{C}$; $I_{FM} = 3140\text{ A}$
$V_{R(TO)}$	Forward threshold voltage, max	V	0.80	$T_j = T_{j\text{ max}}$;
r_T	Forward slope resistance, max	$\text{m}\Omega$	0.170	$0.5 \pi I_{FAV} < I_T < 1.5 \pi I_{FAV}$
BLOCKING				
I_{RRM}	Repetitive peak reverse current, max	mA	70	$T_j = T_{j\text{ max}}$; $V_R = V_{RRM}$
THERMAL				
R_{thjc}	Thermal resistance, junction to case			180° half-sine wave, 50 Hz
	per module	$^\circ\text{C/W}$	0.0420	
R_{thch}	Thermal resistance, case to heatsink			
	per module	$^\circ\text{C/W}$	0.0100	
INSULATION				
V_{ISOL}	Insulation test voltage	kV	3.00	Sine wave, 50 Hz; RMS
			3.60	
MECHANICAL				
M_1	Mounting torque (M6) ¹⁾	Nm	6.00	Tolerance $\pm 15\%$
M_2	Terminal connection torque (M12) ¹⁾	Nm	18.00	Tolerance $\pm 10\%$
w	Weight, max	g	2250	

PART NUMBERING GUIDE						NOTES				
MD	1	-	1125	-	28	-	E	-	N	¹⁾ The screws must be lubricated
1	2		3		4		5		6	
1. MD - Rectifier Diode 2. Circuit Schematic 3. Average Forward Current, A 4. Voltage Code 5. Package Type (M.E) 6. Ambient Conditions: N – Normal										
		UL certified file-No. E255404								

The information contained herein is confidential and protected by Copyright.
 In the interest of product improvement, Proton-Electrotex reserves the right to change data sheet without notice.

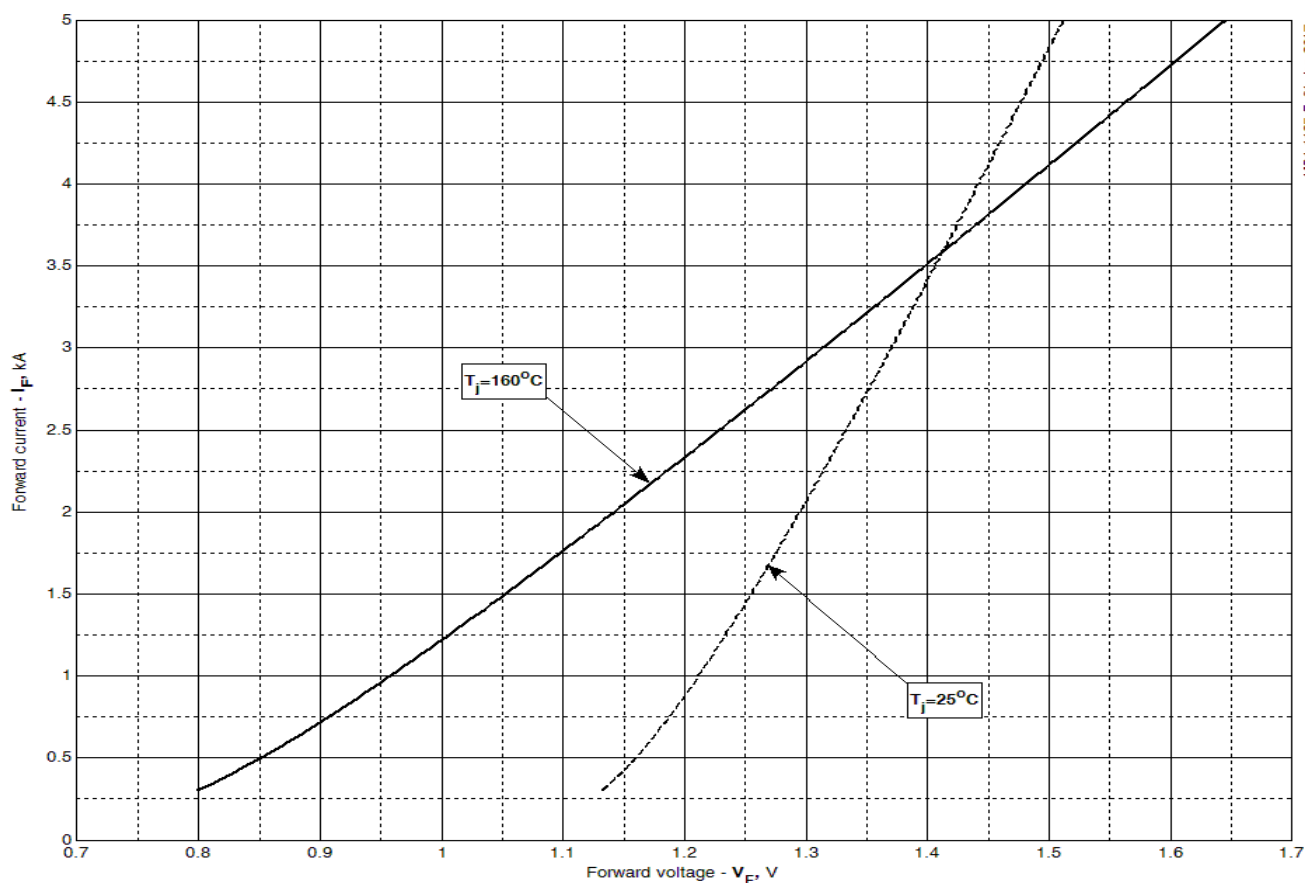

Fig 1 – Forward characteristics of Limit device

Analytical function for Forward characteristic:

$$V_F = A + B \cdot i_F + C \cdot \ln(i_F + 1) + D \cdot \sqrt{i_F}$$

	Coefficients for max curves	
	$T_j = 25^\circ\text{C}$	$T_j = T_{j,max}$
A	1.015039	0.609956
B	0.034063	0.112227
C	-0.152271	-0.221253
D	0.267739	0.389031

Forward characteristic model (see Fig. 1).

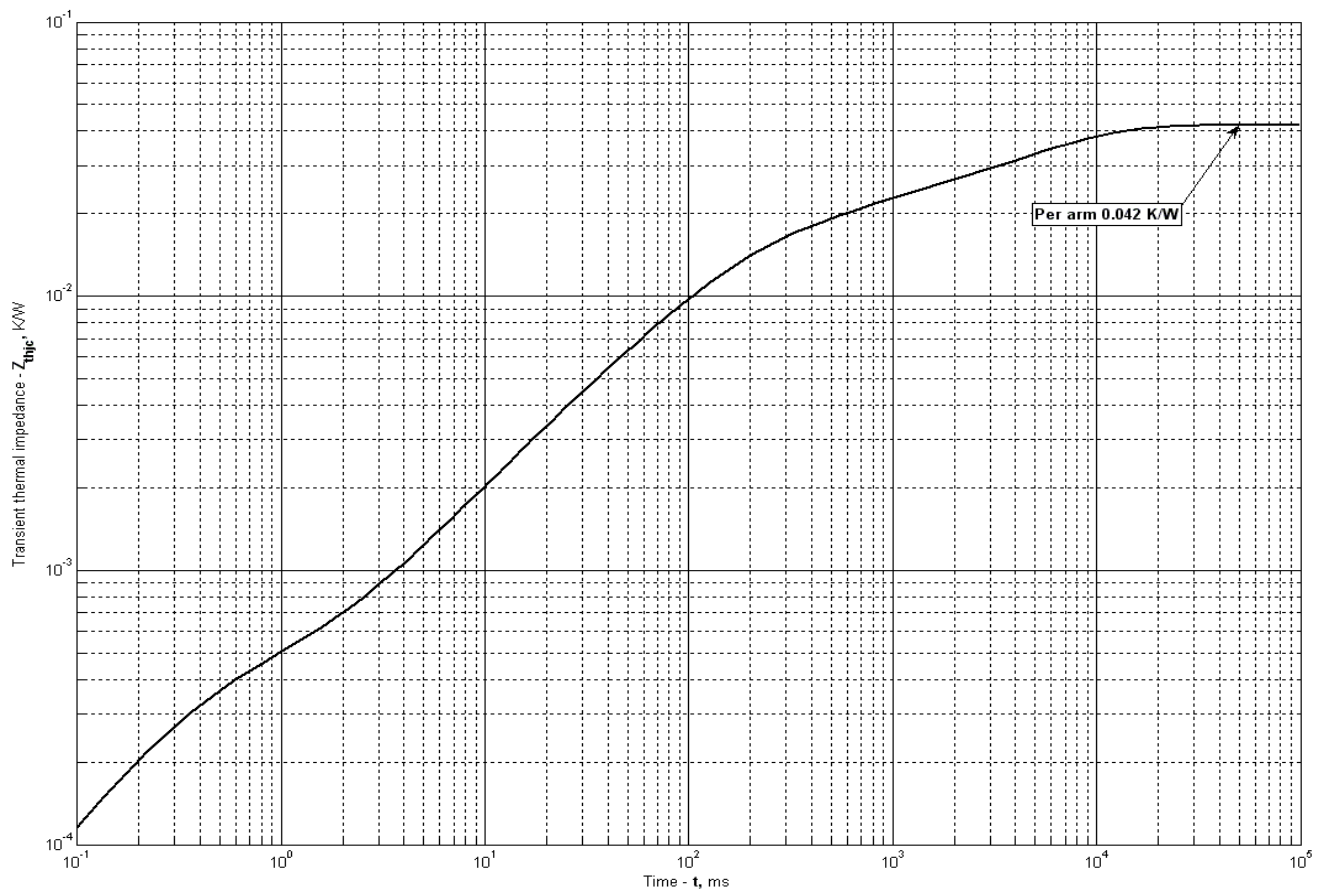

Fig 2 – Transient thermal impedance

Analytical function for Transient thermal impedance junction to case Z_{thjc} for DC:

$$Z_{thjc} = \sum_{i=1}^n R_i \left(1 - e^{-\frac{t}{\tau_i}} \right)$$

Where $i = 1$ to n , n is the number of terms in the series.

t = Duration of heating pulse in seconds.

Z_{thjc} = Thermal resistance at time t .

R_i = Amplitude of p_{th} term.

τ_i = Time constant of r_{th} term.

DC Double side cooled

i	1	2	3	4	5	6
R_i, K/W	0.02105	0.005931	0.009502	0.004252	0.001006	0.0003132
τ_i, s	5.887	0.7389	0.1616	0.08215	0.01267	0.0002712

Transient thermal impedance junction to case Z_{thjc} model (see Fig. 2)

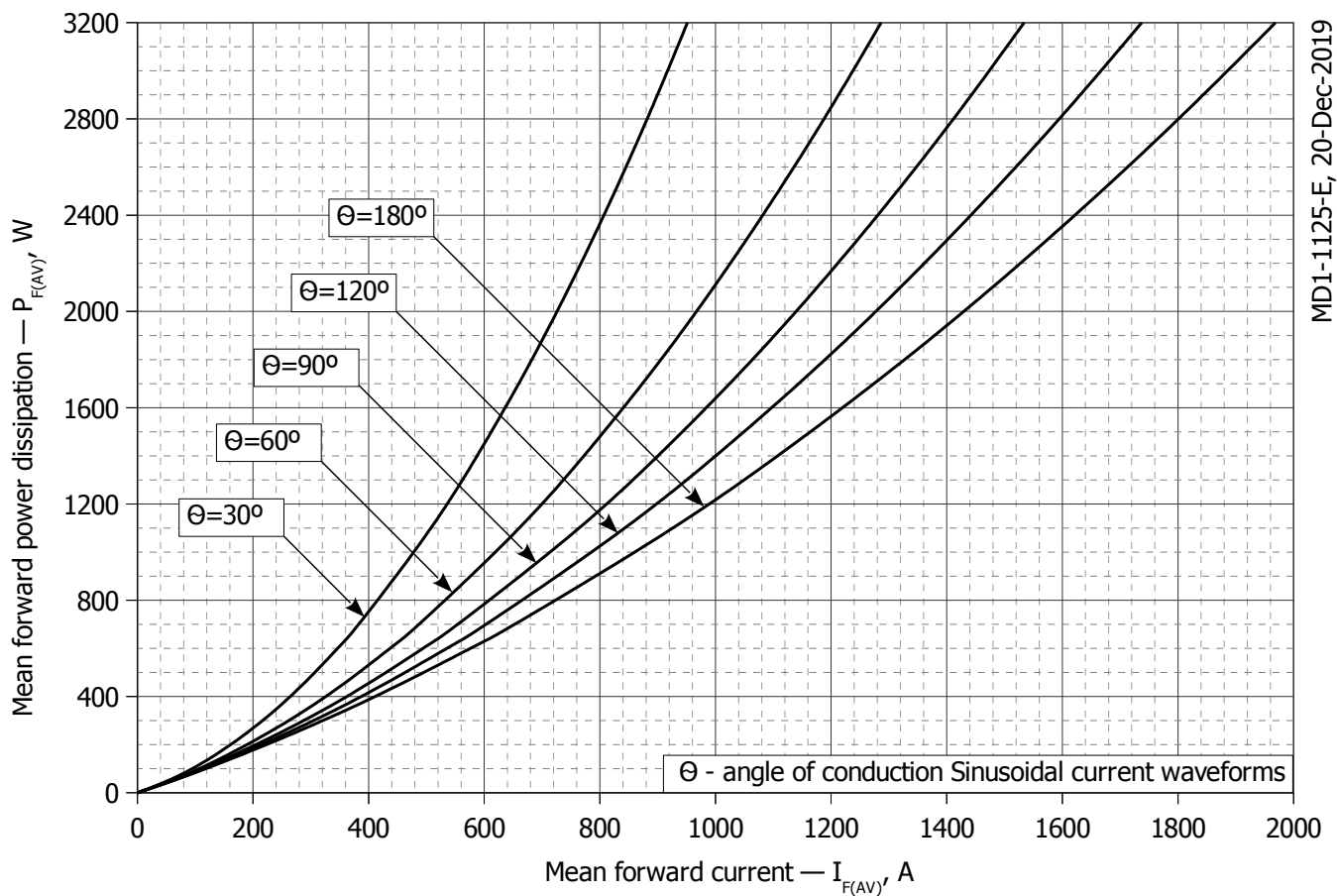

MD1-1125-E, 20-Dec-2019

Fig 3 – Mean forward power dissipation P_{FAV} vs. Mean forward current I_{FAV} for sinusoidal current waveforms at different conduction angles (f=50Hz, DSC)

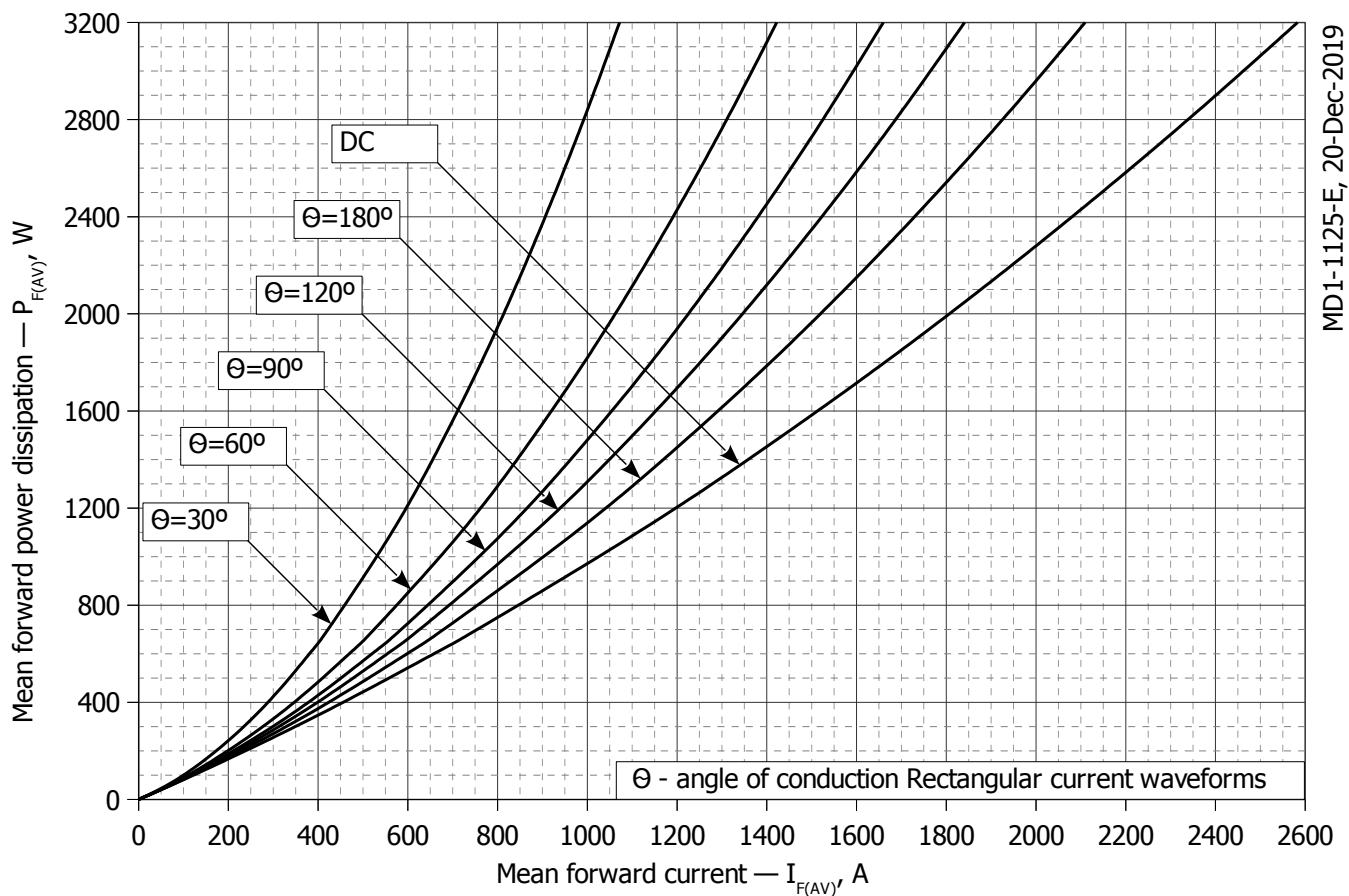

MD1-1125-E, 20-Dec-2019

Fig 4 – Mean forward power dissipation P_{FAV} vs. Mean forward current I_{FAV} for rectangular current waveforms at different conduction angles and for DC (f=50Hz, DSC)

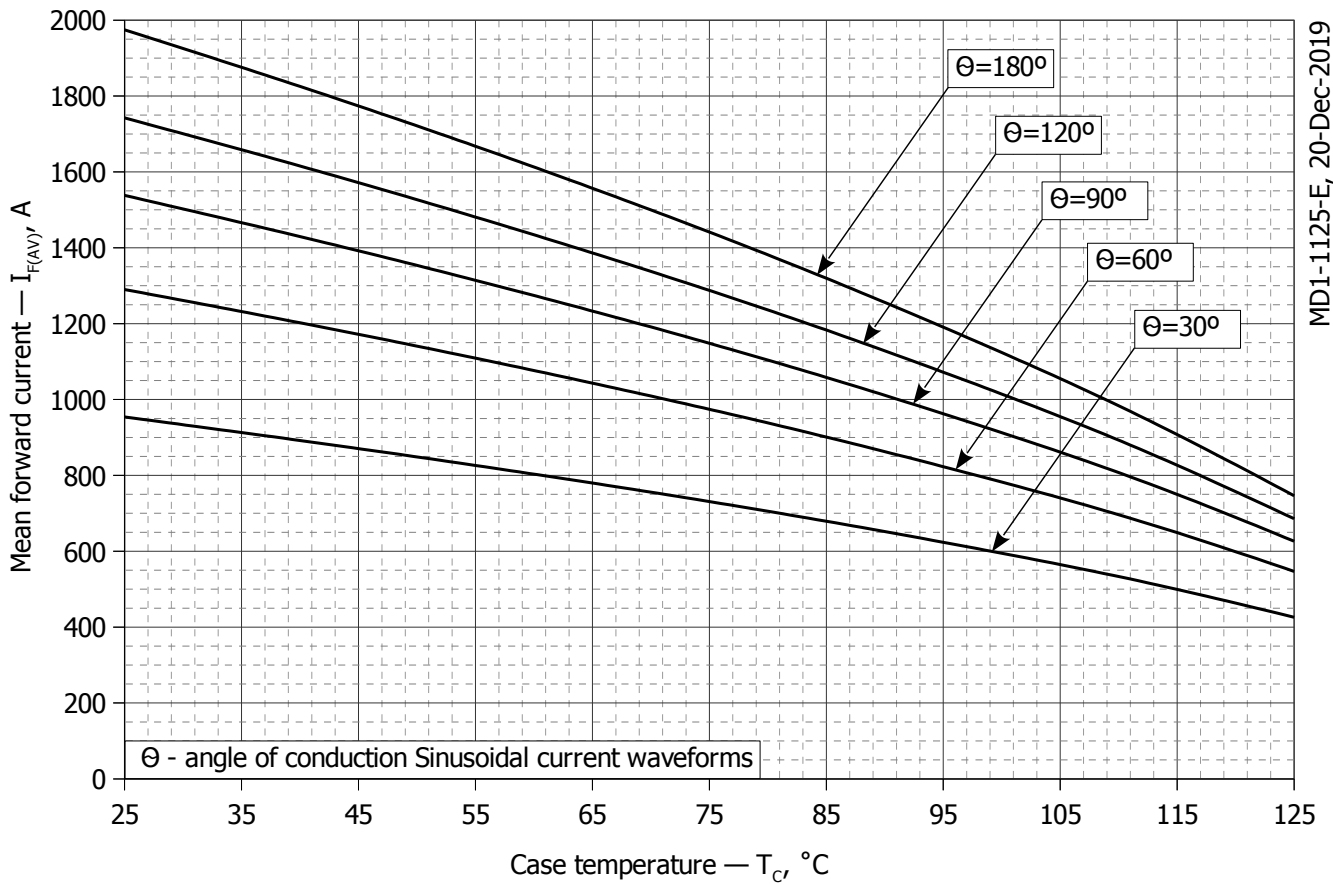

Fig 5 - Mean forward current I_{FAV} vs. Case temperature T_c for sinusoidal current waveforms at different conduction angles ($f=50\text{Hz}$, DSC)

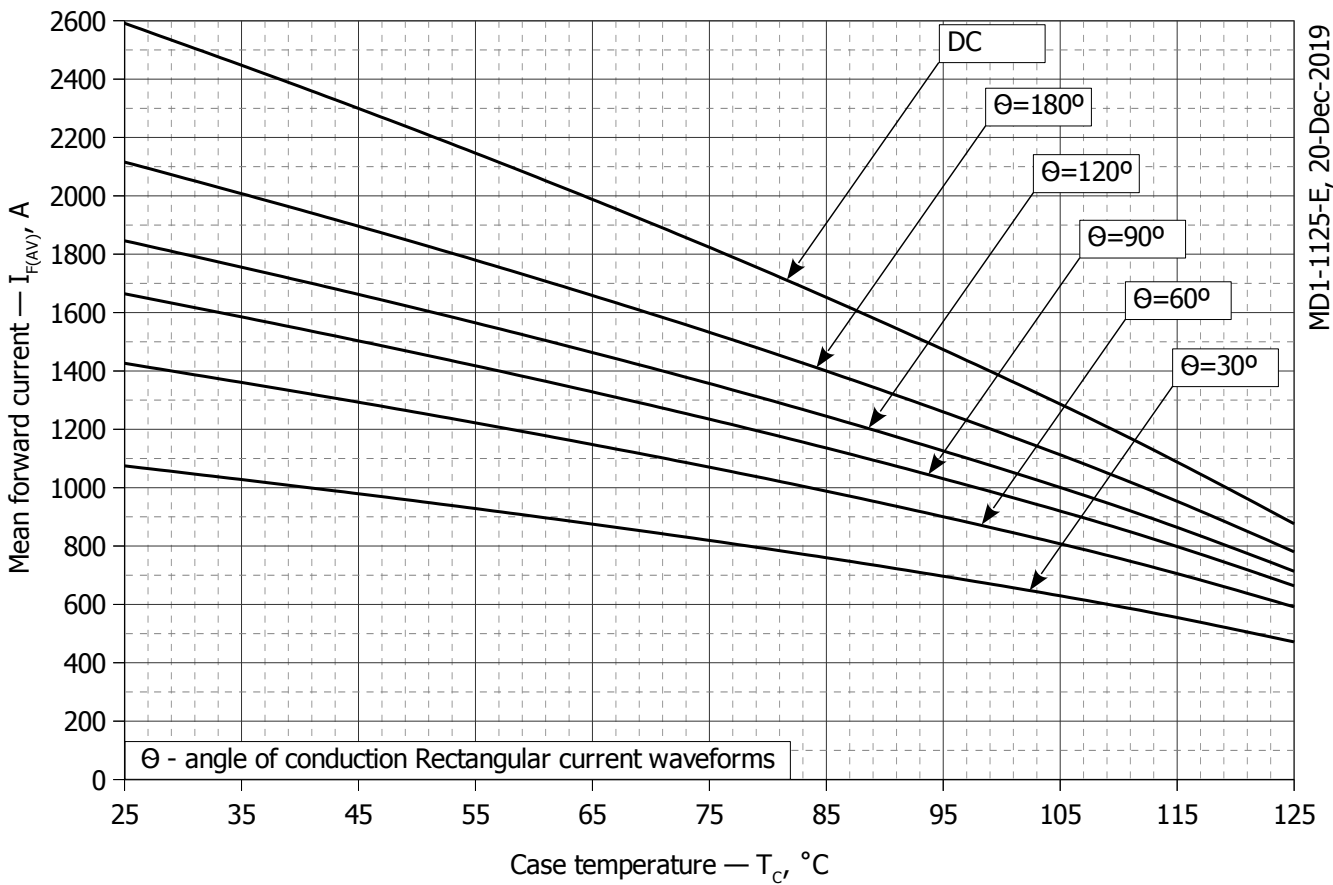

Fig 6 - Mean forward current I_{FAV} vs. Case temperature T_c for rectangular current waveforms at different conduction angles and for DC ($f=50\text{Hz}$, DSC)

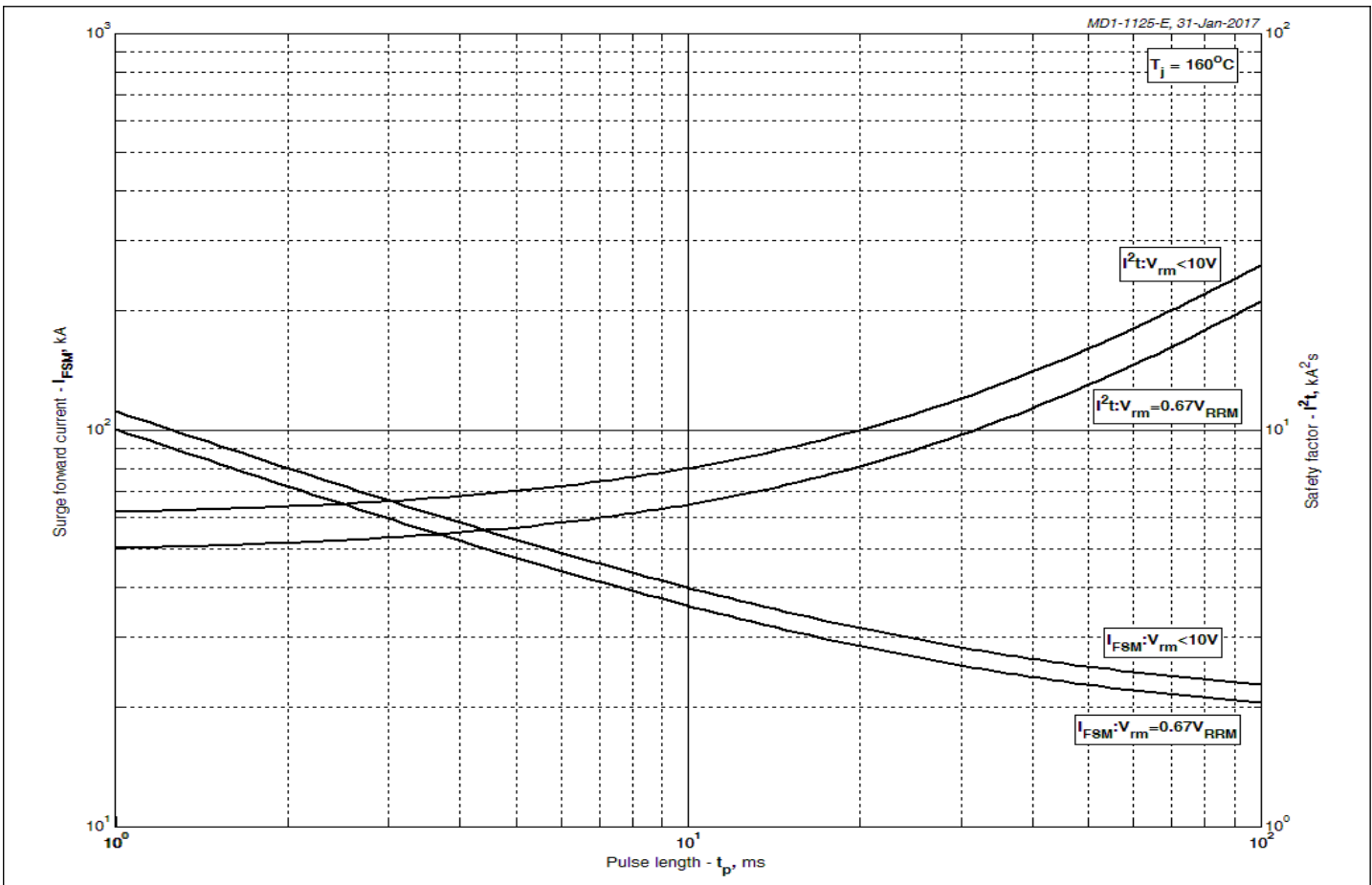

Fig 7 – Maximum surge and I^2t ratings

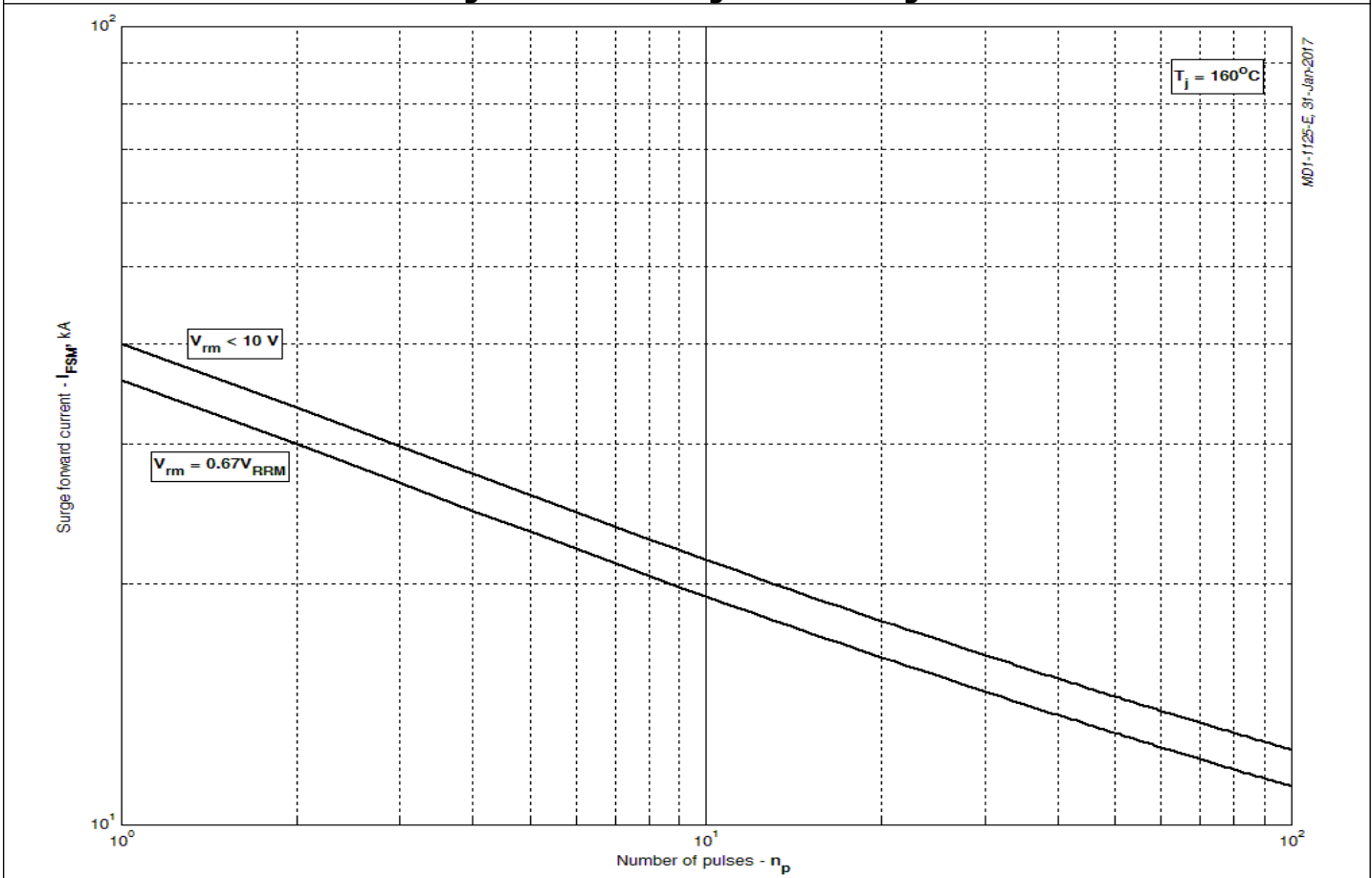

Fig 8 – Maximum surge ratings