

Industry standard 62mm IGBT module

1200 V 200 A

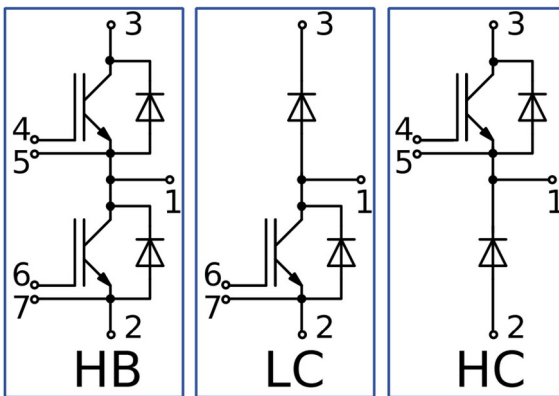
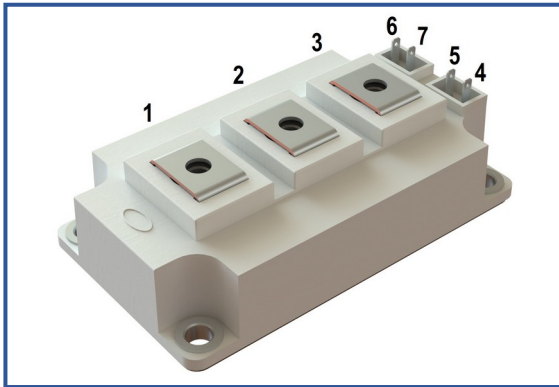

Chip features

- IGBT chip
 - Trench FS
 - low $V_{CE(sat)}$ value
 - 10 μs short circuit of 150°C
 - square RBSOA of $2 \times I_C$
 - low EMI
- FRD chip
 - fast and soft reverse recovery
 - low voltage drop

Design features

- copper baseplate
- Al_2O_3 DBC substrate
- ultrasonically welded power terminals
- Improved thermal cycling
- RoHS compliant

Typical application

- AC motor drives
- solar inverter
- air conditioning
- high power converters and UPS

Maximum rated values

Definition	Symbol	Conditions	Value	Unit
IGBT				
Collector-Emitter voltage	V_{CES}	$V_{GE} = 0$.	1200	V
Collector current (nominal)	$I_{C\ nom}$		200	A
Collector current (maximum continuous)	$I_{C\ 25}$	$T_{vj\ (max)} = 175^\circ C; T_c = 25^\circ C$.	296	A
	$I_{C\ 80}$	$T_{vj\ (max)} = 175^\circ C; T_c = 80^\circ C$.	200	A
Repetitive peak collector current ^{*1}	I_{CRM}	$I_{CRM} = 3 \times I_{C\ nom}; t_p = 1\ ms$.	600	A
Short-circuit duration	t_{psc}	$T_{vj} = 25^\circ C; V_{GE} = \pm 15\ V; V_{CE} = 720\ V;$ $R_{G\ on} = R_{G\ off} = 2.2\ \Omega; I_{C\ max} < 1200\ A$.	10	μs
		$T_{vj} = 150^\circ C; V_{GE} = \pm 15\ V; V_{CE} = 720\ V;$ $R_{G\ on} = R_{G\ off} = 2.2\ \Omega; I_{C\ max} < 1100\ A$.	10	
Gate-Emitter voltage	V_{GES}		± 20	V
Junction operating temperature	$T_{vj\ (op)}$		-40...+150	°C
Inverse diode \ Freewheeling diode				
Repetitive peak reverse voltage	V_{RRM}	$V_{GE} = 0\ V$.	1200	V
Forward current (nominal)	$I_{F\ nom}$		200	A
Forward current (maximum continuous)	$I_{F\ 25}$	$T_{vj\ (max)} = 175^\circ C; T_c = 25^\circ C$.	218	A
	$I_{F\ 80}$	$T_{vj\ (max)} = 175^\circ C; T_c = 80^\circ C$.	165	A
Repetitive peak forward current ^{*1}	I_{FRM}	$I_{FRM} = 3 \times I_{F\ nom}; t_p = 1\ ms$.	600	A
Junction operating temperature	$T_{vj\ (op)}$		-40...+150	°C
Module				
Storage temperature	T_{stg}		-55...+50	°C
Isolation voltage	V_{isol}	AC sin 50 Hz; t = 1 min.	4000	V

*1 Pulse width and repetition rate should be such that device junction temperature does not exceed maximum T_{vj} rating.

Characteristics

Definition	Symbol	Conditions	Value			Unit		
			min.	typ.	max.			
IGBT								
Collector-Emitter saturation voltage	V_{CEsat}	$V_{GE} = +15\text{ V}; I_C = 200\text{ A}; t_u = 1000\text{ }\mu\text{s}.$	$T_{vj} = 25^\circ\text{C}$ $T_{vj} = 150^\circ\text{C}$	1.83 2.39	1.85 2.47	2.02 2.75	V V	
Gate-Emitter threshold voltage	$V_{GE(th)}$	$I_C = 8\text{ mA}; V_{CE} = V_{GE}; T_{vj} = 25^\circ\text{C}; t_u = 2\text{ ms}.$		5.50	6.06	6.50	V	
Collector-Emitter cut-off current	I_{CES}	$V_{CE} = 1200\text{ V}; t_u = 10\text{ ms}; V_{GE} = 0.$	$T_{vj} = 25^\circ\text{C}$ $T_{vj} = 150^\circ\text{C}$	2.38 1.09	3.01 1.22	300 5.00	μA mA	
Gate-Emitter leakage current	I_{GES}	$V_{CE} = 0; V_{GE} = \pm 20\text{ V}; T_{vj} = 25^\circ\text{C}; t_u = 30\text{ ms}.$		15.6	17.3	400	nA	
Input capacitance	C_{ies}	$V_{CE} = 10\text{ V}; V_{GE} = 0\text{ V}; f = 1\text{ MHz}; T_{vj} = 25^\circ\text{C}.$		-	18.2	-	nF	
Output capacitance	C_{oes}			-	1.40	-	nF	
Reverse transfer capacitance	C_{res}			-	1.60	-	nF	
Total gate charge	Q_G	$I_C = 200\text{ A}; V_{CE} = 600\text{ V}; V_{GE} = -8 \div 15\text{ V}.$		-	2078	2192	nC	
Internal gate resistance	R_{Gint}	$T_{vj} = 25^\circ\text{C}.$		-	3.75	-	Ω	
Turn-on delay time	$t_{d(on)}$	$V_{CE} = 600\text{ V}; V_{GE} = \pm 15\text{ V}; I_{Cmax} = 200\text{ A}; R_G = 2.2\text{ }\Omega; L = 56\text{ nH}.$	$T_{vj} = 25^\circ\text{C}$ $T_{vj} = 150^\circ\text{C}$	369 405	377 417	440 470	ns	
Rise time	t_{ri}		$T_{vj} = 25^\circ\text{C}$ $T_{vj} = 150^\circ\text{C}$	50.0 56.0	53.4 58.5	70.0 75.0	ns	
Turn-on energy	E_{on}		$T_{vj} = 25^\circ\text{C}$ $T_{vj} = 150^\circ\text{C}$	7.76 14.8	8.63 15.9	13.0 21.0	mJ	
Turn-off delay time	$t_{d(off)}$		$T_{vj} = 25^\circ\text{C}$ $T_{vj} = 150^\circ\text{C}$	451 518	461 533	520 650	ns	
Fall time	t_{fi}		$T_{vj} = 25^\circ\text{C}$ $T_{vj} = 150^\circ\text{C}$	241 308	252 324	330 430	ns	
Turn-off energy	E_{off}		$T_{vj} = 25^\circ\text{C}$ $T_{vj} = 150^\circ\text{C}$	16.3 21.6	17.0 22.4	23.0 30.0	mJ	
Collector-emitter threshold voltage	V_{CE0}		$V_{GE} = +15\text{ V}; T_{vj} = 150^\circ\text{C};$		0.85	0.86	0.90	V
On-State slope resistance (IGBT)	r_{CE0}		$I_{CE1} = 50\text{ A}; I_{CE2} = 200\text{ A}; t_u = 1000\text{ }\mu\text{s}.$		7.67	8.04	9.14	m Ω
Thermal resistance junction to case	$R_{th(j-c)}$		DC; $I_{CE} = 200 \pm 20\text{ A}; I_{test} = 1.0\text{ A}; V_{GE} = +15\text{ V}.$		-	0.086	0.160	K/W
Inverse diode \ Freewheeling diode								
Forward voltage drop	V_F	$I_F = 200\text{ A}; V_{GE} = 0; t_u = 500\text{ }\mu\text{s}.$	$T_{vj} = 25^\circ\text{C}$ $T_{vj} = 150^\circ\text{C}$	1.99 2.01	2.07 2.20	2.25 2.50	V V	
Reverse recovery time	t_{rr}	$V_{GE} = \pm 15\text{ V}; V_{CE} = 600\text{ V}; I_{Cmax} = 200\text{ A}; R_{Gon} = 2.2\text{ }\Omega; L = 56\text{ nH}.$	$T_{vj} = 25^\circ\text{C}$ $T_{vj} = 150^\circ\text{C}$	113 161	117 171	140 310	ns ns	
Peak reverse recovery current	I_{rrM}		$T_{vj} = 25^\circ\text{C}$ $T_{vj} = 150^\circ\text{C}$	161 198	167 210	210 260	A A	
Reverse recovered charge	Q_{rr}		$T_{vj} = 25^\circ\text{C}$ $T_{vj} = 150^\circ\text{C}$	11.0 20.0	12.0 21.0	16.0 30.0	μC μC	
Reverse recovery energy	E_{rec}		$T_{vj} = 25^\circ\text{C}$ $T_{vj} = 150^\circ\text{C}$	5.00 13.0	6.00 14.0	9.00 20.0	mJ mJ	
Threshold voltage	$V_{(TO)}$		$T_{vj} = 150^\circ\text{C}; V_{GE} = 0; I_{CE1} = 50\text{ A};$		0.83	0.84	0.89	V
Forward slope resistance	r_T		$I_{CE2} = 200\text{ A}; t_u = 1000\text{ }\mu\text{s}.$		5.87	6.79	8.00	m Ω
Thermal resistance junction to case	$R_{th(jc-D)}$	DC; $I_{CE} = 180 \pm 20\text{ A}; I_{test} = 1.0\text{ A}; V_{GE} = +15\text{ V}.$		-	0.196	0.260	K/W	

Module							
Pin resistance	R_{Pxy}	$T_{vj} = 25^{\circ}\text{C}.$	R_{P12}	-	0.28	0.50	m Ω
			R_{P13}	-	0.38	0.50	
Parasitic inductance between terminals	L_{Pce}			-	22	-	nH
Thermal resistance case to heatsink	R_{thCH}	per module		-	0.02	0.04	K/W
Mounting torque for screws to heatsink	M_s	to heatsink M6		3.00	-	5.00	N*m
Mounting torque for terminal screws	M_t	to terminals M6		2.25	2.50	2.75	N*m
Weight	W			-	320	340	g

Notes:

- Insulating material operating temperature 125°C max;
- Case temperature 125°C max;
- The recommended operating junction temperature $T_{vj\ op} = -40 \div +150^{\circ}\text{C}.$

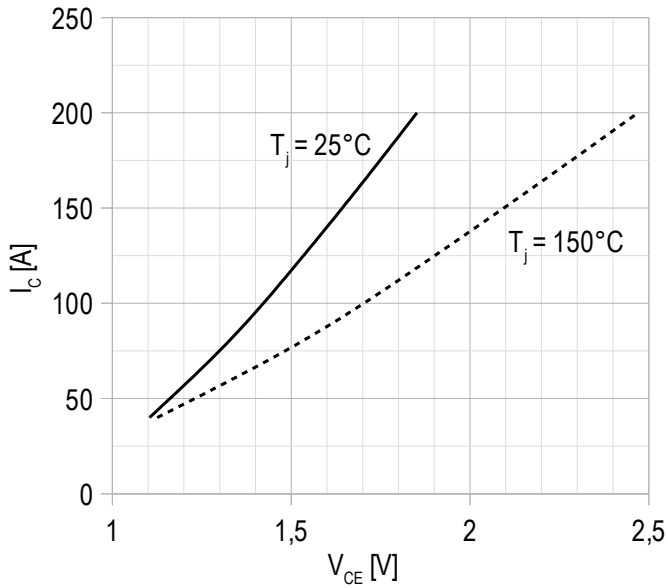
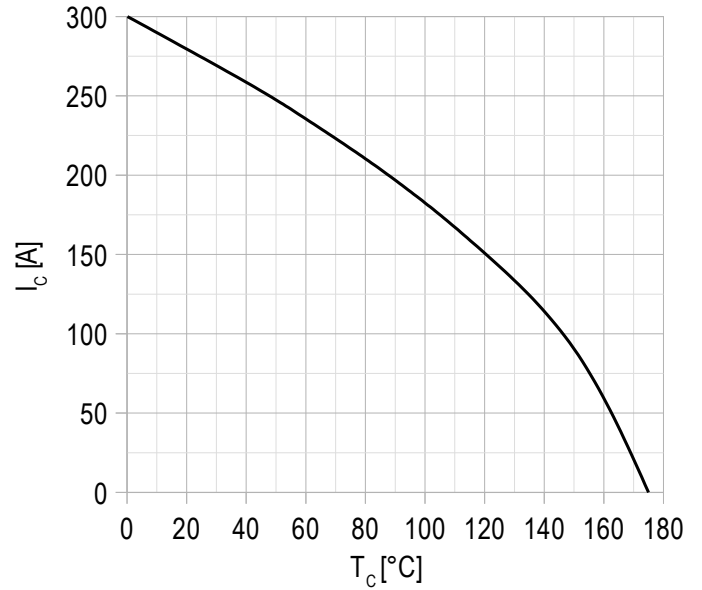
Chart 1 – typ. output characteristic, IGBT.

 $V_{GE} = +15 \text{ V.}$
Chart 2 – max. rated current vs temperature.

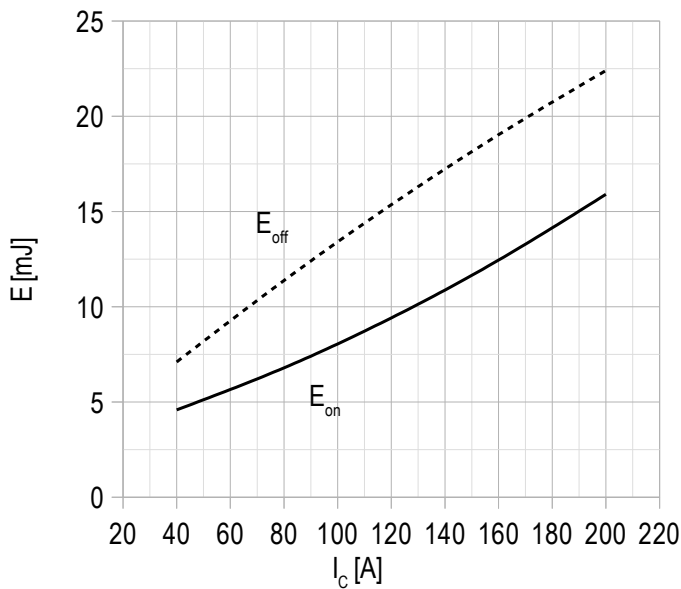
DC;
 $V_{GE} = +15 \text{ V;}$
 $T_{vj(max)} = 150^\circ\text{C.}$

Chart 3 – typ. turn-on/-off energy vs rated current, IGBT.

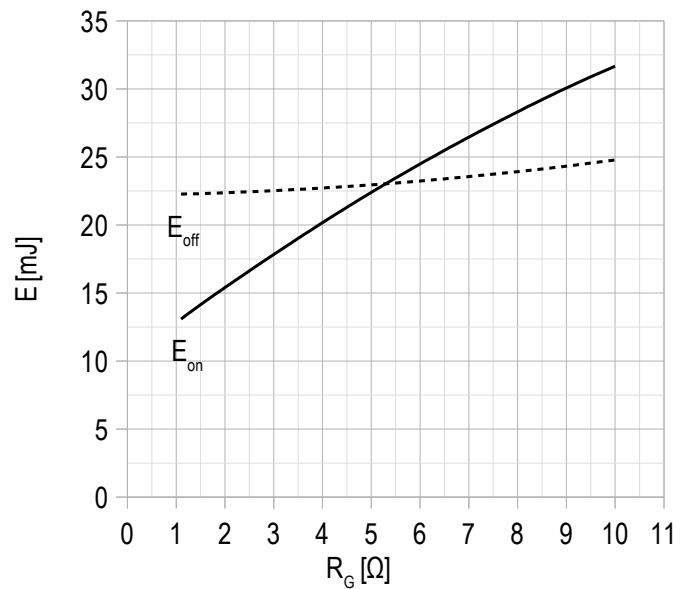
$V_{CE} = 600 \text{ V;}$
 $V_{GE} = \pm 15 \text{ V;}$
 $R_G = 2.2 \ \Omega;$
 $L = 56 \text{ nH;}$
 $T_{vj(max)} = 150^\circ\text{C.}$

Chart 4 – typ. turn-on/-off energy vs gate resistance, IGBT.

$V_{CE} = 600 \text{ V;}$
 $V_{GE} = \pm 15 \text{ V;}$
 $I_{Cmax} = 200 \text{ A;}$
 $L = 56 \text{ nH;}$
 $T_{vj(max)} = 150^\circ\text{C.}$

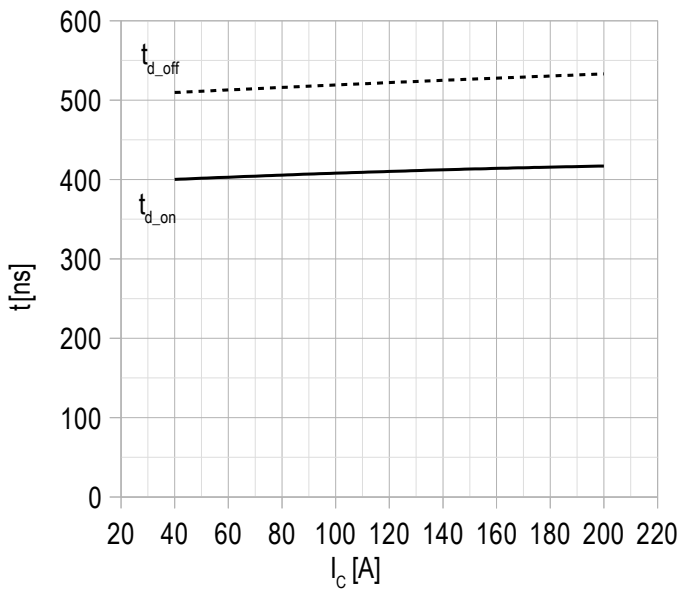
Chart 5 – typ. switching times vs rated current, IGBT.

$V_{CE} = 600$ V;
 $V_{GE} = \pm 15$ V;
 $R_G = 2.2$ Ω ;
 $L = 56$ nH;
 $T_{vj(max)} = 150^\circ\text{C}$.

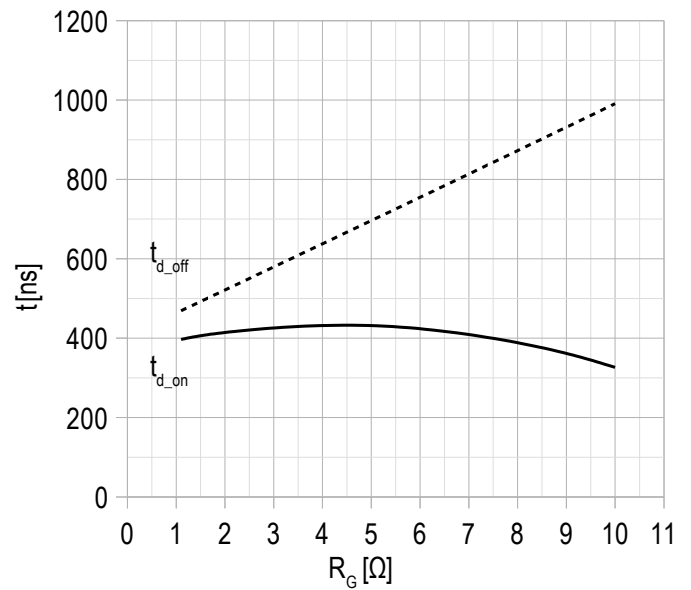
Chart 6 – typ. switching times vs gate resistance, IGBT.

$V_{CE} = 600$ V;
 $V_{GE} = \pm 15$ V;
 $I_{Cmax} = 200$ A;
 $L = 56$ nH;
 $T_{vj(max)} = 150^\circ\text{C}$.

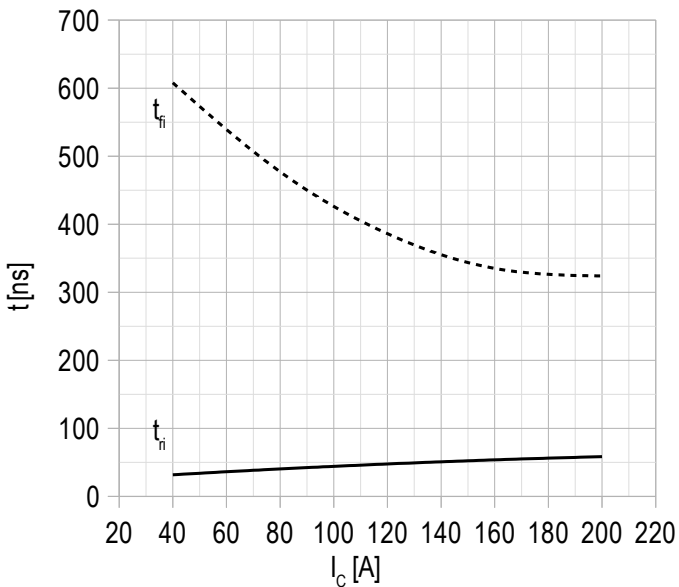
Chart 7 – typ. switching times vs rated current, IGBT.

$V_{CE} = 600$ V;
 $V_{GE} = \pm 15$ V;
 $R_G = 2.2$ Ω ;
 $L = 56$ nH.
 $T_{vj(max)} = 150^\circ\text{C}$.

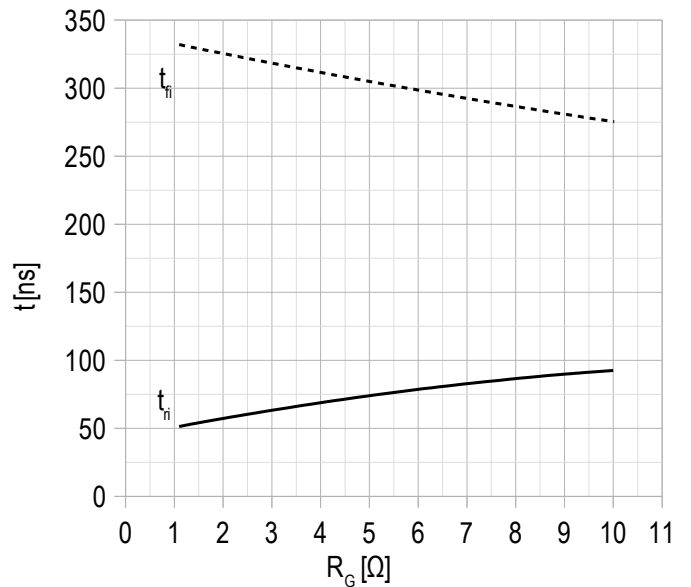
Chart 8 – typ. switching times vs gate resistance, IGBT.

$V_{CE} = 600$ V;
 $V_{GE} = \pm 15$ V;
 $I_{Cmax} = 200$ A;
 $L = 56$ nH.
 $T_{vj(max)} = 150^\circ\text{C}$.

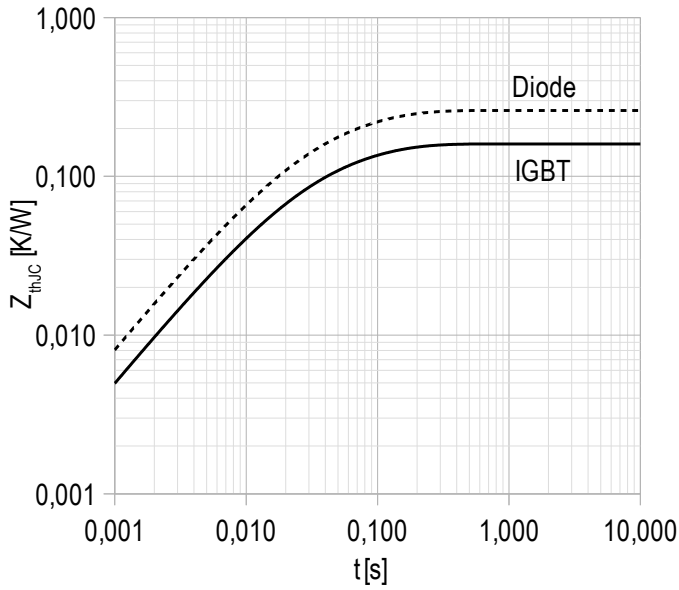
Chart 9 – max. transient thermal impedance.

Single pulse;
 $V_{GE} = +15\text{ V}$.

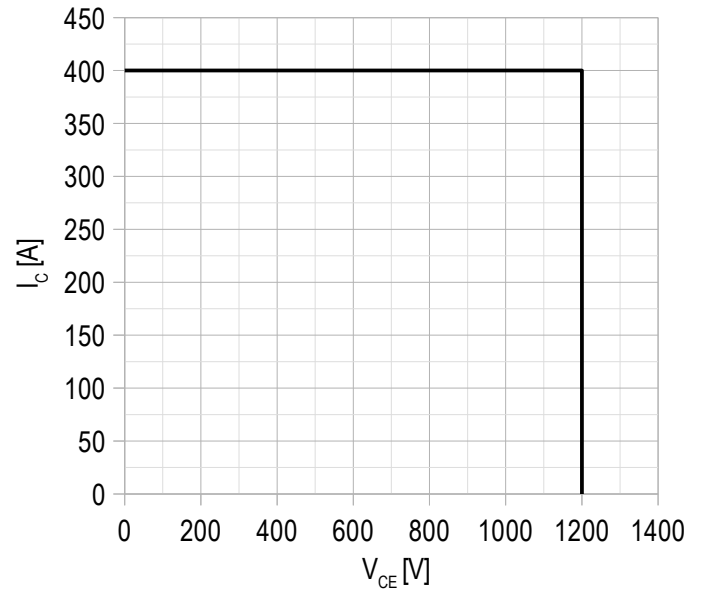
Chart 10 – RBSOA.

$V_{CE\text{ max}} = 1200\text{ V}$;
 $V_{GE} = \pm 15\text{ V}$;
 $I_{C\text{ max}} = 2 \cdot I_{C\text{ nom}}$;
 $R_G = 2.2\ \Omega$;
 $L = 56\text{ nH}$.

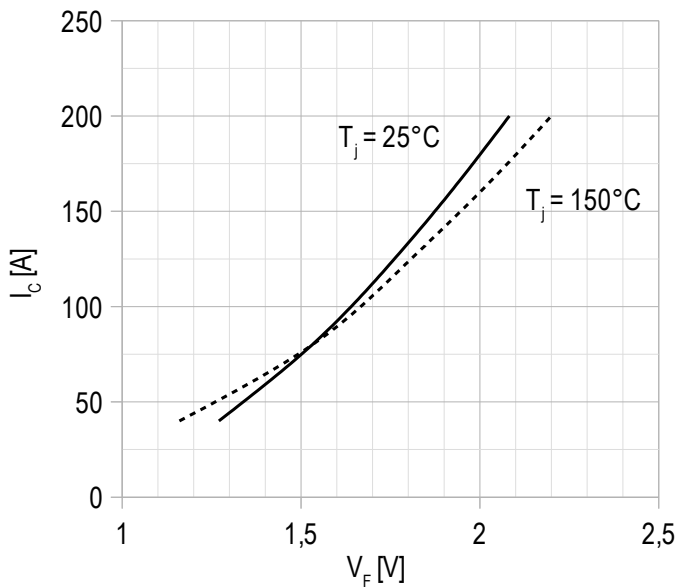
Chart 11 – typ. output characteristic, FRD.

$V_{GE} = +15\text{ V}$.

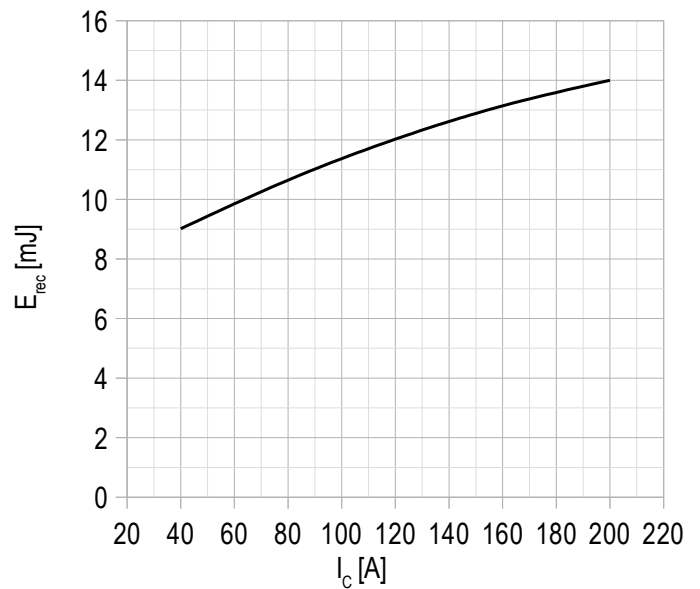
Chart 12 – typ. switching losses vs rated current, FRD.

$V_{GE} = \pm 15\text{ V}$;
 $V_{CE} = 600\text{ V}$;
 $L = 56\text{ nH}$;
 $R_{G\text{ on}} = 2.2\ \Omega$;
 $T_{vj\text{ (max)}} = 150^\circ\text{C}$.

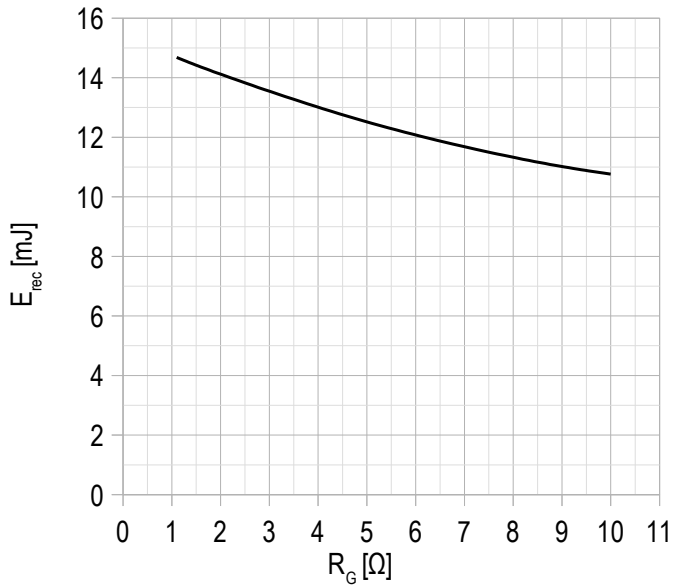
Chart 13 – typ. swithing losses vs gate resistanse, FRD.

$V_{GE} = \pm 15$ V;
 $V_{CE} = 600$ V;
 $I_{C\ max} = 200$ A;
 $L = 56$ nH;
 $T_{vj\ (max)} = 150^\circ$ C.

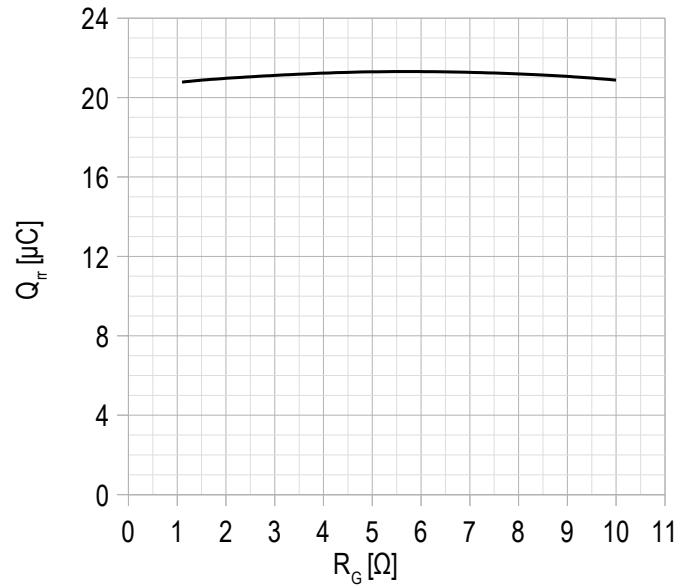
Chart 14 – typ. reverse recovered charge vs gate resistance, FRD.

$V_{GE} = \pm 15$ V;
 $V_{CE} = 600$ V;
 $I_{C\ max} = 200$ A;
 $L = 56$ nH;
 $T_{vj\ (max)} = 150^\circ$ C.

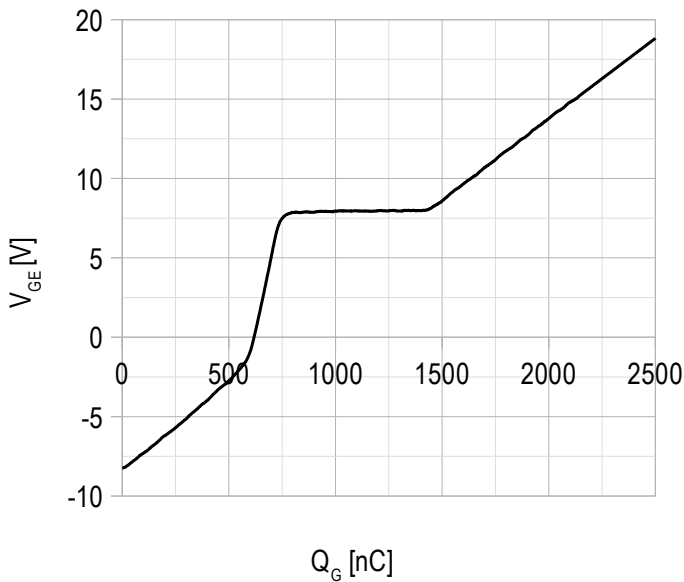
Chart 15 – typ. gate charge characteristic.

$I_C = 200$ A;
 $V_{CE} = 600$ V;
 $V_{GE} = - 8 \div 15$ V.

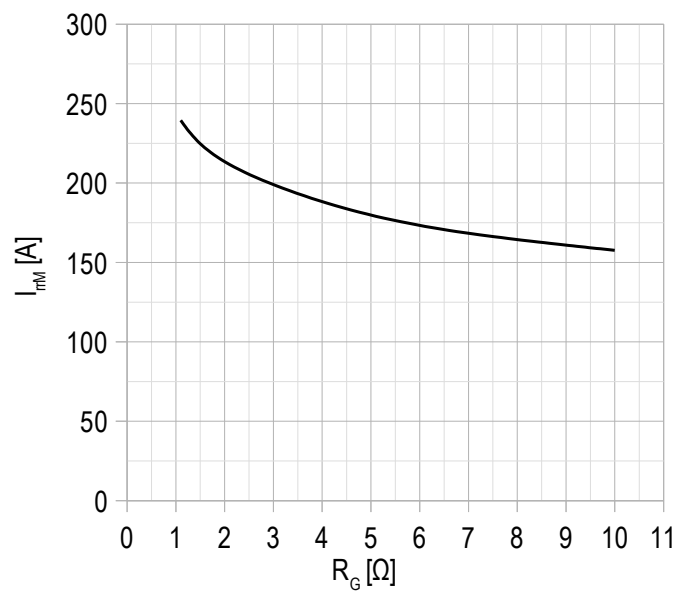
Chart 16 – typ. reverse recovery current vs gate resistance FRD.

$V_{CE} = 600$ V;
 $V_{GE} = \pm 15$ V;
 $L = 56$ nH.
 $T_{vj\ (max)} = 150^\circ$ C.

Chart 17 – typ. rated current vs frequency.

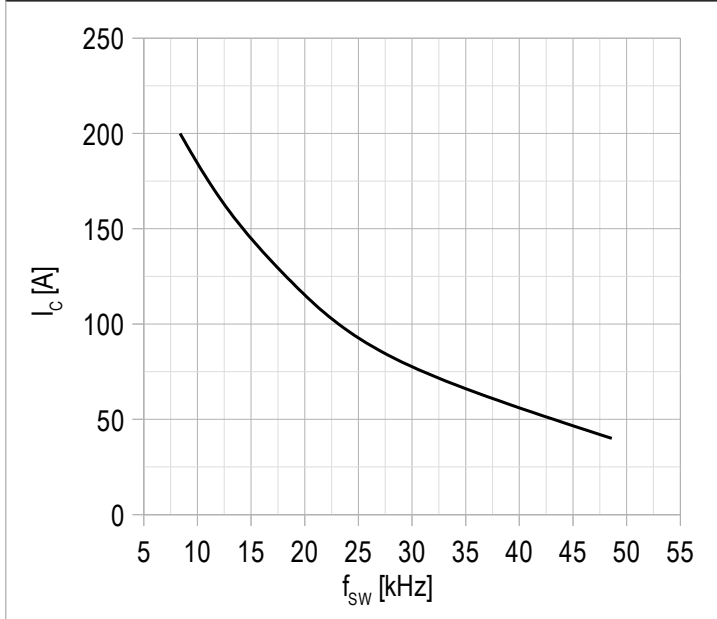

Duty cycle 50%;
 $T_c = 80\text{ }^\circ\text{C}$;
 $T_{vj(max)} = 175\text{ }^\circ\text{C}$.

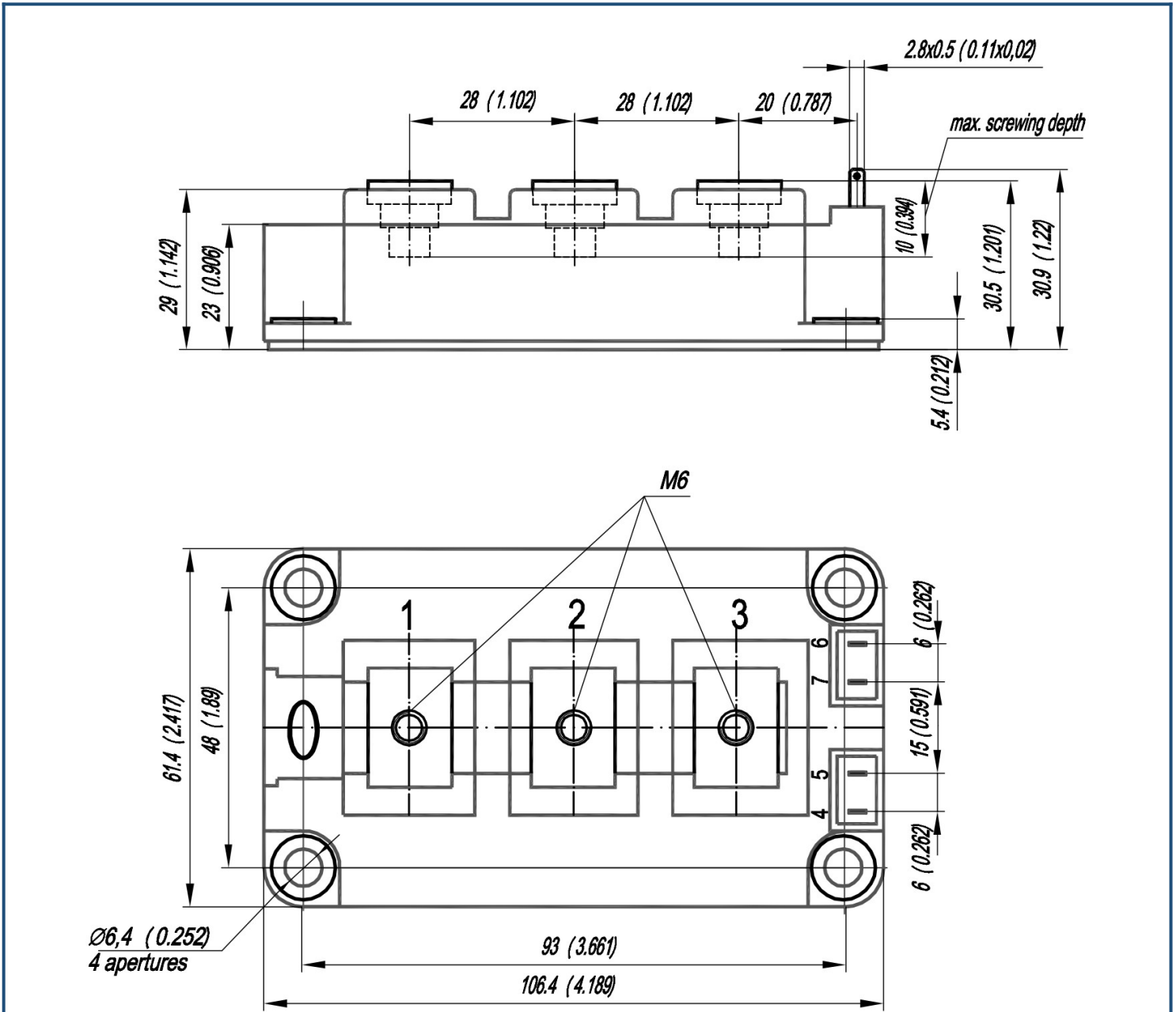
Overall dimensions: Package type – AA

Part numbering guide

MIAA	-	HB	12	AA	-	200	N	
MIAA								IGBT module package type: AA
		HB						2 switches as Half-Bridge
		HC						1 switch as High-Side chopper
		LC						1 switch as Low-Side chopper
			12					Voltage rating ($V_{CES}/100$)
				AA				IGBT+FRD chipset modification
						200		Current Rating
							N	Climatic version: normal climate

The information contained herein is protected by Copyright. In the interest of product improvement, Proton-Electrotex reserves the right to change datasheet without notice.