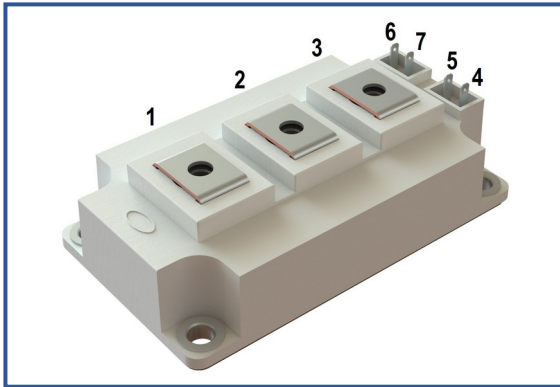

## Industry standard 62mm IGBT module

1200 V 300 A

**Chip features**

- IGBT chip
  - Trench FS
  - low  $V_{CE(sat)}$  value
  - 10  $\mu$ s short circuit of 150°C
  - square RBSOA of 2xl<sub>c</sub>
  - low EMI
- FRD chip
  - fast and soft reverse recovery
  - low voltage drop

**Design features**

- copper baseplate
- Al<sub>2</sub>O<sub>3</sub> DBC substrate
- ultrasonically welded power terminals
- Improved thermal cycling
- RoHS compliant

**Typical application**

- AC motor drives
- solar inverter
- air conditioning
- high power converters and UPS

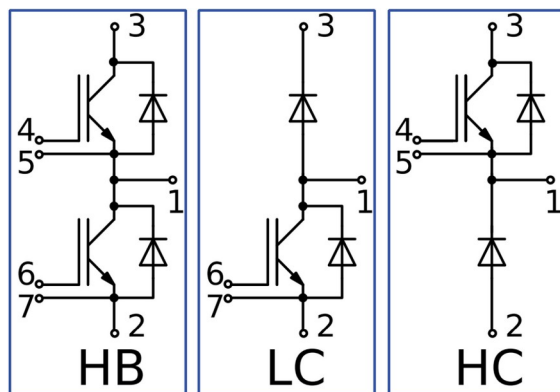
**Maximum rated values**

Definition	Symbol	Conditions	Value	Unit
<b>IGBT</b>				
Collector-Emitter voltage	$V_{CES}$	$V_{GE} = 0$ .	1200	V
Collector current (nominal)	$I_{C\ nom}$		300	A
Collector current (maximum continuous)	$I_{C\ 25}$	$T_{vj\ (max)} = 175^{\circ}C; T_c = 25^{\circ}C$ .	421	A
	$I_{C\ 80}$	$T_{vj\ (max)} = 175^{\circ}C; T_c = 80^{\circ}C$ .	300	A
Repetitive peak collector current* <sup>1</sup>	$I_{CRM}$	$I_{CRM} = 3 \times I_{C\ nom}; t_p = 1\ ms$ .	900	A
Short-circuit duration	$t_{psc}$	$T_{vj} = 25^{\circ}C; V_{GE} = \pm 15\ V; V_{CE} = 720\ V;$ $R_{G\ on} = R_{G\ off} = 2.2\ \Omega; I_{C\ max} < 1600\ A$ .	10	$\mu$ s
		$T_{vj} = 150^{\circ}C; V_{GE} = \pm 15\ V; V_{CE} = 720\ V;$ $R_{G\ on} = R_{G\ off} = 2.2\ \Omega; I_{C\ max} < 1520\ A$ .	10	
Gate-Emitter voltage	$V_{GES}$		$\pm 20$	V
Junction operating temperature	$T_{vj\ (op)}$		-40...+150	°C
<b>Inverse diode \ Freewheeling diode</b>				
Repetitive peak reverse voltage	$V_{RRM}$	$V_{GE} = 0\ V$ .	1200	V
Forward current (nominal)	$I_{F\ nom}$		300	A
Forward current (maximum continuous)	$I_{F\ 25}$	$T_{vj\ (max)} = 175^{\circ}C; T_c = 25^{\circ}C$ .	345	A
	$I_{F\ 80}$	$T_{vj\ (max)} = 175^{\circ}C; T_c = 80^{\circ}C$ .	260	A
Repetitive peak forward current* <sup>1</sup>	$I_{FRM}$	$I_{FRM} = 3 \times I_{F\ nom}; t_p = 1\ ms$ .	900	A
Junction operating temperature	$T_{vj\ (op)}$		-40...+150	°C
<b>Module</b>				
Storage temperature	$T_{stg}$		-55...+50	°C
Isolation voltage	$V_{isol}$	AC sin 50 Hz; t = 1 min.	4000	V

\*<sup>1</sup> Pulse width and repetition rate should be such that device junction temperature does not exceed maximum  $T_{vj}$  rating

**Characteristics**

Definition	Symbol	Conditions	Value			Unit		
			min.	typ.	max.			
<b>IGBT</b>								
Collector-Emitter saturation voltage	$V_{CEsat}$	$V_{GE} = +15\text{ V}; I_C = 300\text{ A}; t_u = 1000\ \mu\text{s}.$	$T_{vj} = 25^\circ\text{C}$ $T_{vj} = 150^\circ\text{C}$	1.82 2.40	1.84 2.45	1.98 2.57	V V	
Gate-Emitter threshold voltage	$V_{GE(th)}$	$I_C = 12\text{ mA}; V_{CE} = V_{GE}; T_{vj} = 25^\circ\text{C}; t_u = 2\text{ ms}.$		5.65	6.07	6.45	V	
Collector-Emitter cut-off current	$I_{CES}$	$V_{CE} = 1200\text{ V}; t_u = 20\text{ ms}; V_{GE} = 0.$	$T_{vj} = 25^\circ\text{C}$ $T_{vj} = 150^\circ\text{C}$	37.8 1.40	55.5 1.55	300 4.00	$\mu\text{A}$ mA	
Gate-Emitter leakage current	$I_{GES}$	$V_{CE} = 0; V_{GE} = \pm 20\text{ V}; T_{vj} = 25^\circ\text{C}; t_u = 30\text{ ms}.$		8.36	11.6	400	nA	
Input capacitance	$C_{ies}$	$V_{CE} = 10\text{ V}; V_{GE} = 0\text{ V}; f = 1\text{ MHz}; T_{vj} = 25^\circ\text{C}.$		-	27.6	-	nF	
Output capacitance	$C_{oes}$		-	2.00	-	nF		
Reverse transfer capacitance	$C_{res}$		-	2.40	-	nF		
Total gate charge	$Q_G$	$I_C = 300\text{ A}; V_{CE} = 600\text{ V}; V_{GE} = -8 \div 15\text{ V}.$		-	3052	3255	nC	
Internal gate resistance	$R_{Gint}$	$T_{vj} = 25^\circ\text{C}.$		-	2.50	-	$\Omega$	
Turn-on delay time	$t_{d(on)}$	$V_{CE} = 600\text{ V}; V_{GE} = \pm 15\text{ V}; I_{Cmax} = 300\text{ A}; R_G = 2.2\ \Omega; L = 56\text{ nH}.$	$T_{vj} = 25^\circ\text{C}$ $T_{vj} = 150^\circ\text{C}$	373 485	380 494	490 560	ns	
Rise time	$t_{ri}$		$T_{vj} = 25^\circ\text{C}$ $T_{vj} = 150^\circ\text{C}$	59 73	64 76	85 90	ns	
Turn-on energy	$E_{on}$		$T_{vj} = 25^\circ\text{C}$ $T_{vj} = 150^\circ\text{C}$	9.60 24.5	12.0 28.0	22.0 34.0	mJ	
Turn-off delay time	$t_{d(off)}$		$T_{vj} = 25^\circ\text{C}$ $T_{vj} = 150^\circ\text{C}$	481 673	536 693	690 770	ns	
Fall time	$t_{fi}$		$T_{vj} = 25^\circ\text{C}$ $T_{vj} = 150^\circ\text{C}$	209 276	234 288	290 390	ns	
Turn-off energy	$E_{off}$		$T_{vj} = 25^\circ\text{C}$ $T_{vj} = 150^\circ\text{C}$	28.6 36.9	29.0 37.8	35.0 46.0	mJ	
Collector-emitter threshold voltage	$V_{CE0}$		$V_{GE} = +15\text{ V}; T_{vj} = 150^\circ\text{C}; I_{CE1} = 75\text{ A}; I_{CE2} = 300\text{ A}; t_u = 1000\ \mu\text{s}.$		0.83	0.85	0.89	V
On-State slope resistance (IGBT)	$r_{CE0}$				5.20	5.34	6.00	m $\Omega$
Thermal resistance junction to case	$R_{th(j-c)}$		DC; $I_{CE} = 300 \pm 20\text{ A}; I_{test} = 1.0\text{ A}; V_{GE} = +15\text{ V}.$		-	0.080	0.120	K/W
<b>Inverse diode \ Freewheeling diode</b>								
Forward voltage drop	$V_F$	$I_F = 300\text{ A}; V_{GE} = 0; t_u = 500\ \mu\text{s}.$	$T_{vj} = 25^\circ\text{C}$ $T_{vj} = 150^\circ\text{C}$	1.83 2.04	1.87 2.08	2.10 2.23	V V	
Reverse recovery time	$t_{rr}$	$V_{GE} = \pm 15\text{ V}; V_{CE} = 600\text{ V}; I_{Cmax} = 300\text{ A}; L = 56\text{ nH}; R_{Gon} = 2.2\ \Omega.$	$T_{vj} = 25^\circ\text{C}$ $T_{vj} = 150^\circ\text{C}$	127 188	132 195	150 245	ns ns	
Peak reverse recovery current	$I_{rrM}$		$T_{vj} = 25^\circ\text{C}$ $T_{vj} = 150^\circ\text{C}$	232 291	244 301	290 340	A A	
Reverse recovered charge	$Q_{rr}$		$T_{vj} = 25^\circ\text{C}$ $T_{vj} = 150^\circ\text{C}$	17.0 32.0	19.0 33.0	22.0 40.0	$\mu\text{C}$ $\mu\text{C}$	
Reverse recovery energy	$E_{rec}$		$T_{vj} = 25^\circ\text{C}$ $T_{vj} = 150^\circ\text{C}$	9.00 24.0	10.0 25.0	14.0 29.0	mJ mJ	
Threshold voltage	$V_{(T0)}$		$T_{vj} = 150^\circ\text{C}; V_{GE} = 0; I_{CE1} = 75\text{ A}; I_{CE2} = 300\text{ A}; t_u = 1000\ \mu\text{s}.$		0.82	0.83	0.88	V
Forward slope resistance	$r_T$				4.04	4.17	4.60	m $\Omega$
Thermal resistance junction to case	$R_{th(jc-D)}$	DC; $I_{CE} = 250 \pm 20\text{ A}; I_{test} = 1.0\text{ A}; V_{GE} = +15\text{ V}.$		-	0.156	0.180	K/W	

Module							
Pin resistance	$R_{Pxy}$	$T_{vj} = 25^{\circ}\text{C}.$	$R_{P12}$	-	0.28	0.50	m $\Omega$
			$R_{P13}$	-	0.38	0.50	
Parasitic inductance between terminals	$L_{Pce}$			-	22	-	nH
Thermal resistance case to heatsink	$R_{thCH}$	per module			0.02	0.04	K/W
Mounting torque for screws to heatsink	$M_s$	to heatsink M6		3.00	-	5.00	N*m
Mounting torque for terminal screws	$M_t$	to terminals M6		2.25	2.50	2.75	N*m
Weight	$W$			-	320	340	g

**Notes:**

- Insulating material operating temperature 125°C max;
- Case temperature 125°C max;
- The recommended operating junction temperature  $T_{vj\ op} = -40 \div +150^{\circ}\text{C}.$

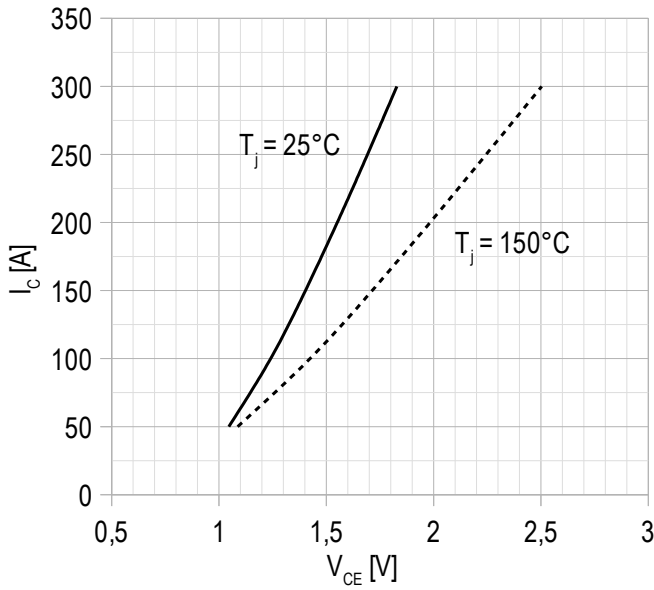
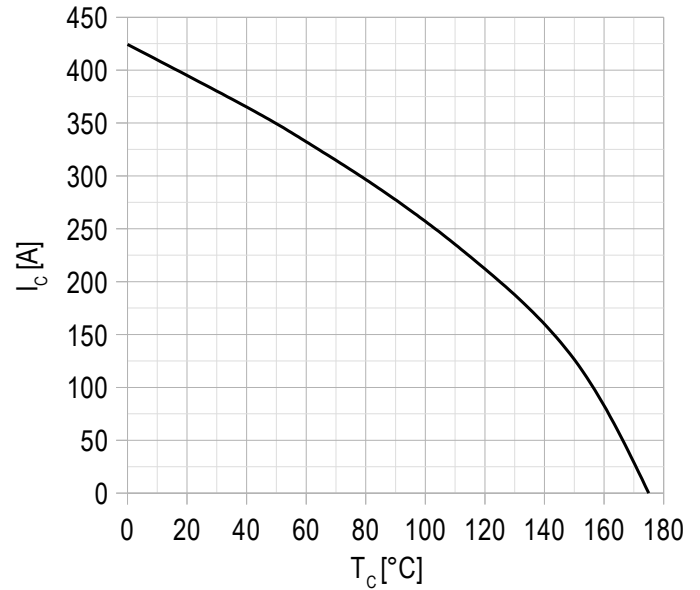
**Chart 1 – typ. output characteristic, IGBT.**

 $V_{GE} = +15 \text{ V.}$ 
**Chart 2 – max. rated current vs temperature.**

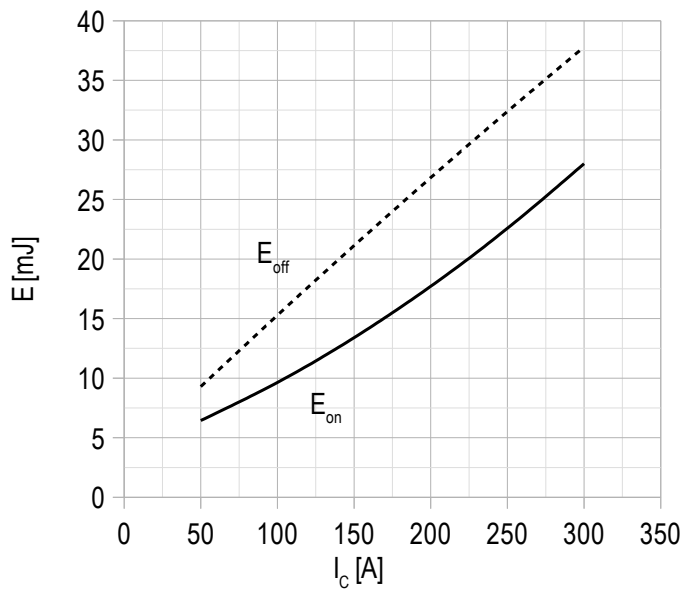
DC;  
 $V_{GE} = +15 \text{ V;}$   
 $T_{vj(max)} = 150^\circ\text{C.}$

**Chart 3 – typ. turn-on/off energy vs rated current, IGBT.**

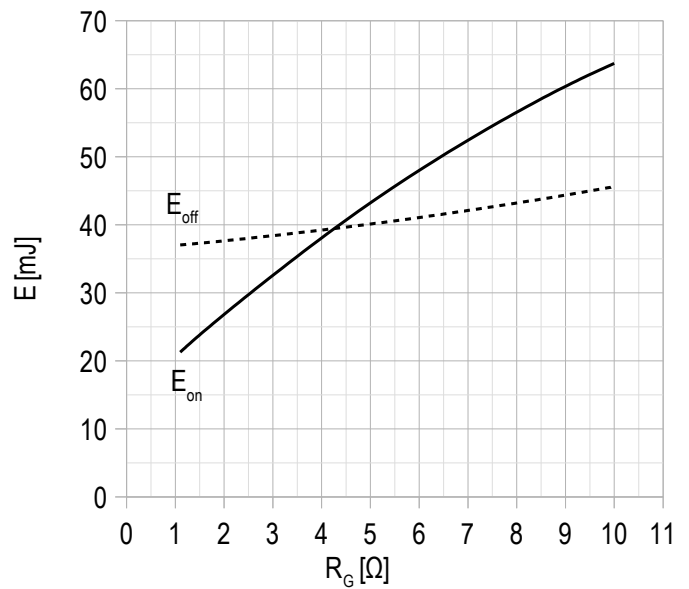
$V_{CE} = 600 \text{ V;}$   
 $V_{GE} = \pm 15 \text{ V;}$   
 $R_G = 2.2 \ \Omega;$   
 $L = 56 \text{ nH;}$   
 $T_{vj(max)} = 150^\circ\text{C.}$

**Chart 4 – typ. turn-on/off energy vs gate resistance, IGBT.**

$V_{CE} = 600 \text{ V;}$   
 $V_{GE} = \pm 15 \text{ V;}$   
 $I_{c(max)} = 300 \text{ A;}$   
 $L = 56 \text{ nH;}$   
 $T_{vj(max)} = 150^\circ\text{C.}$

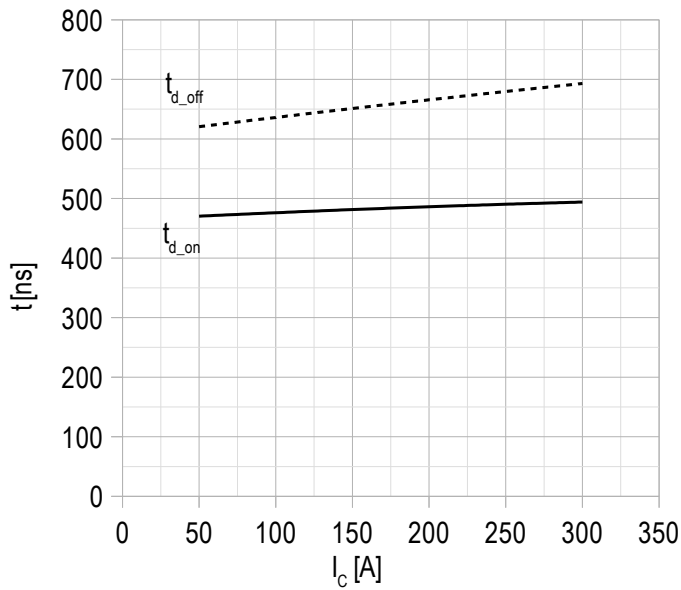
**Chart 5 – typ. switching times vs rated current, IGBT.**

$V_{CE} = 600\text{ V};$   
 $V_{GE} = \pm 15\text{ V};$   
 $R_G = 2.2\ \Omega;$   
 $L = 56\text{ nH};$   
 $T_{vj(max)} = 150^\circ\text{C}.$

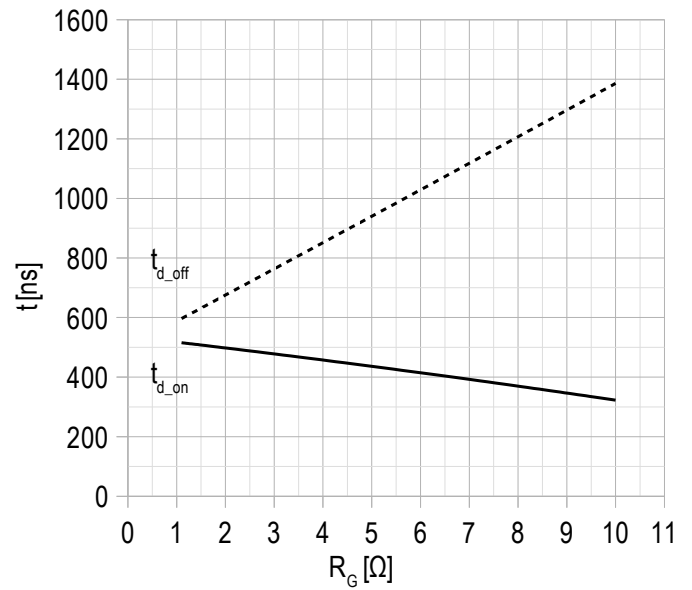
**Chart 6 – typ. switching times vs gate resistance, IGBT.**

$V_{CE} = 600\text{ V};$   
 $V_{GE} = \pm 15\text{ V};$   
 $I_{Cmax} = 300\text{ A};$   
 $L = 56\text{ nH};$   
 $T_{vj(max)} = 150^\circ\text{C}.$

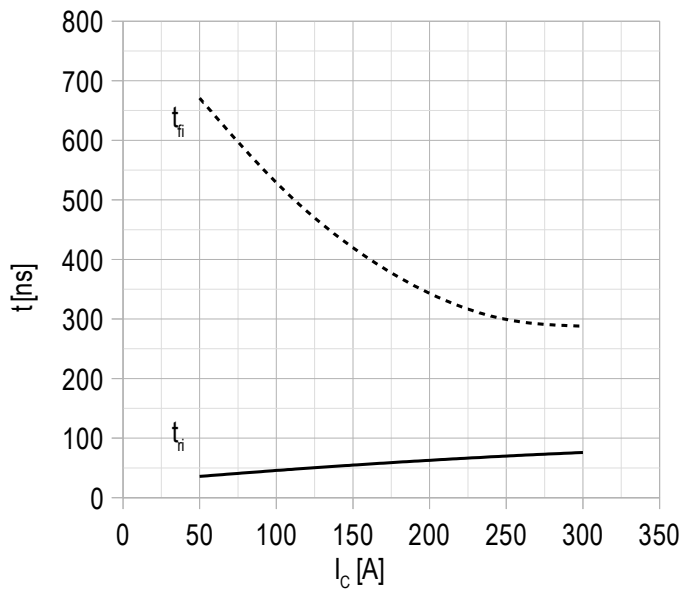
**Chart 7 – typ. switching times vs rated current, IGBT.**

$V_{CE} = 600\text{ V};$   
 $V_{GE} = \pm 15\text{ V};$   
 $R_G = 2.2\ \Omega;$   
 $L = 56\text{ nH};$   
 $T_{vj(max)} = 150^\circ\text{C}.$

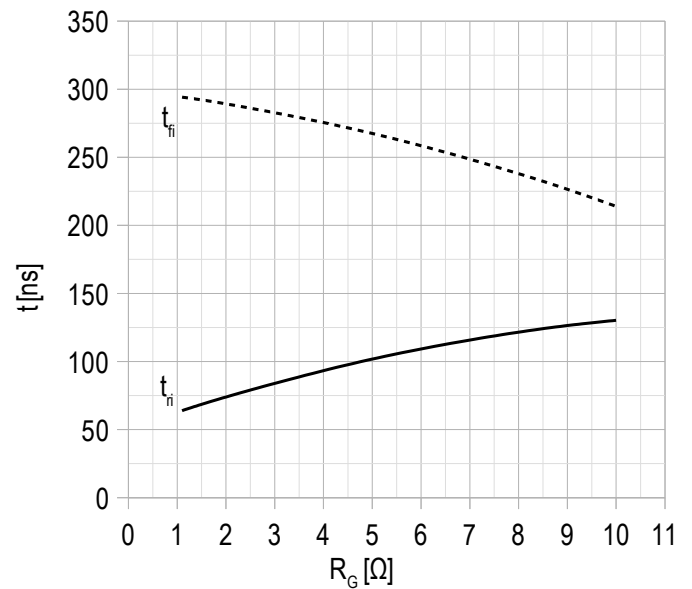
**Chart 8 – typ. switching times vs gate resistance, IGBT.**

$V_{CE} = 600\text{ V};$   
 $V_{GE} = \pm 15\text{ V};$   
 $I_{Cmax} = 300\text{ A};$   
 $L = 56\text{ nH};$   
 $T_{vj(max)} = 150^\circ\text{C}.$

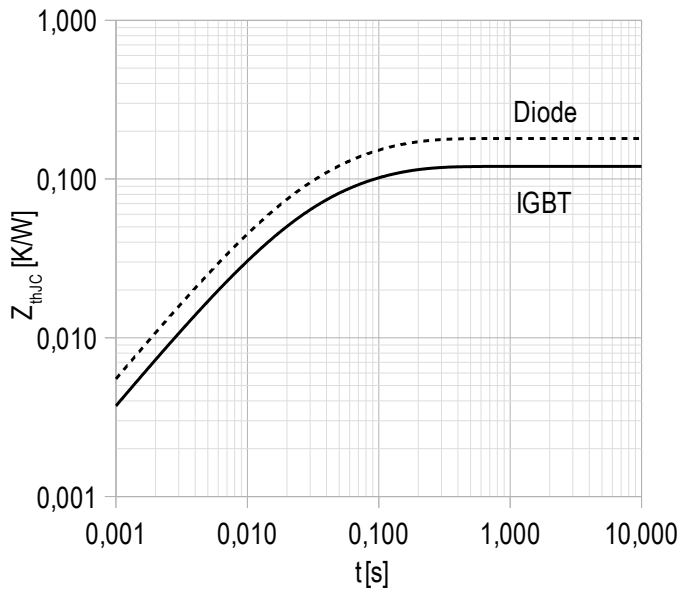
**Chart 9 – max. transient thermal impedance.**

Single pulse;  
 $V_{GE} = +15\text{ V}$ .

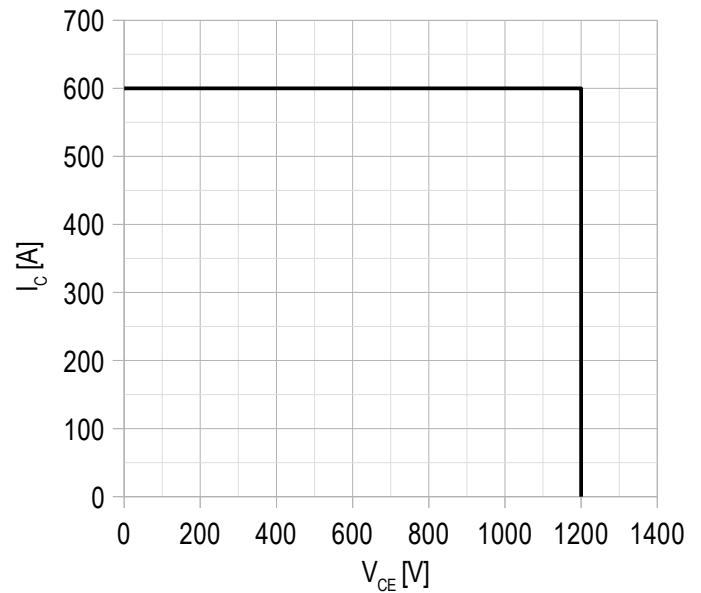
**Chart 10 – RBSOA.**

$V_{CE\text{ max}} = 1200\text{ V}$ ;  
 $V_{GE} = \pm 15\text{ V}$ ;  
 $I_{C\text{ max}} = 2 \cdot I_{C\text{ nom}}$ ;  
 $R_G = 2.2\ \Omega$ ;  
 $L = 56\text{ nH}$ .

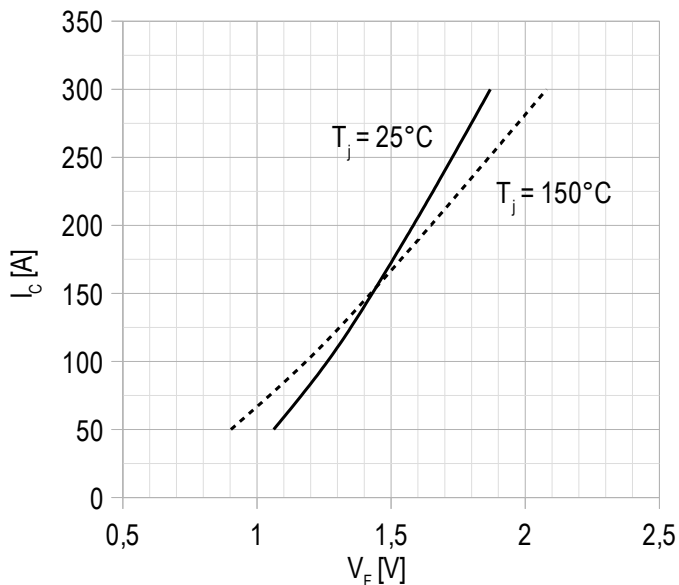
**Chart 11 – typ. output characteristic, FRD.**

$V_{GE} = 0\text{ V}$ .

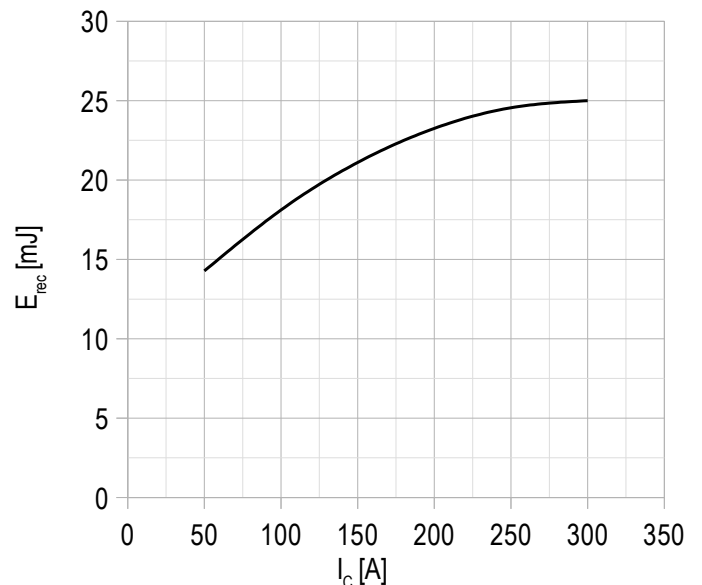
**Chart 12 – typ. switching losses vs rated current, FRD.**

$V_{GE} = \pm 15\text{ V}$ ;  
 $V_{CE} = 600\text{ V}$ ;  
 $L = 56\text{ nH}$ ;  
 $R_{G\text{ on}} = 2.2\ \Omega$ ;  
 $T_{vj\text{ (max)}} = 150^\circ\text{C}$ .

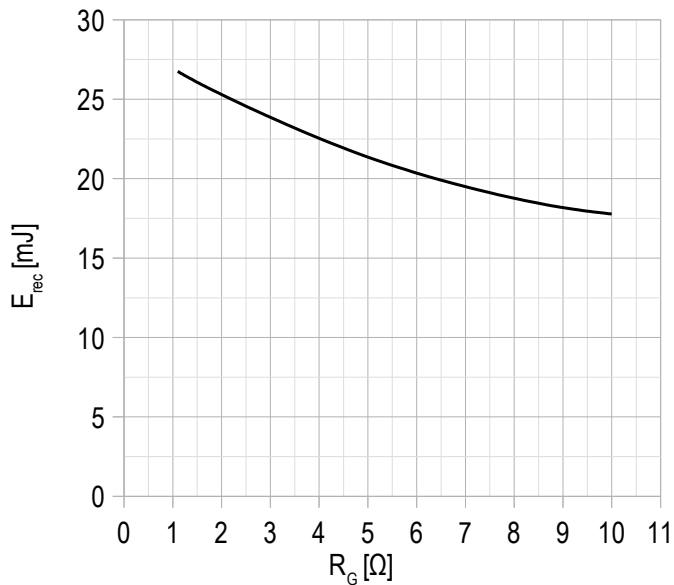
**Chart 13 – typ. switching losses vs gate resistance, FRD.**

$V_{GE} = \pm 15$  V;  
 $V_{CE} = 600$  V;  
 $I_{C\ max} = 300$  A;  
 $L = 56$  nH;  
 $T_{vj\ (max)} = 150^\circ\text{C}$ .

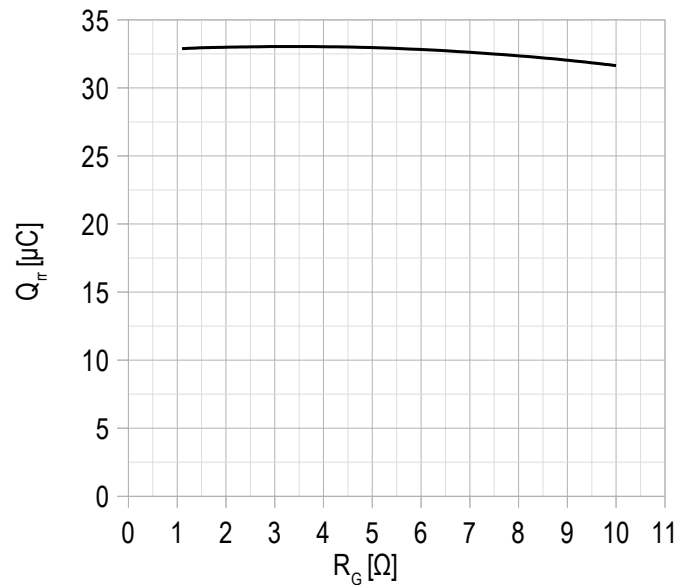
**Chart 14 – typ. reverse recovered charge vs gate resistance, FRD.**

$V_{GE} = \pm 15$  V;  
 $V_{CE} = 600$  V;  
 $I_{C\ max} = 300$  A;  
 $L = 56$  nH;  
 $T_{vj\ (max)} = 150^\circ\text{C}$ .

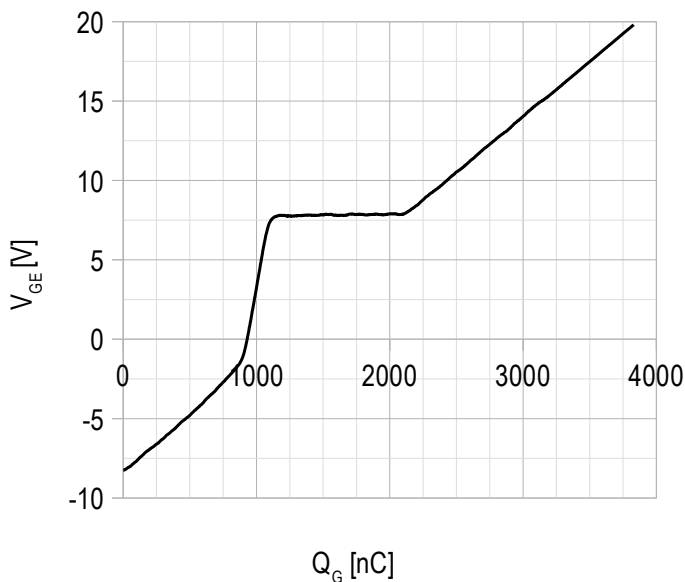
**Chart 15 – typ. gate charge characteristic.**

$I_C = 300$  A;  
 $V_{CE} = 600$  V;  
 $V_{GE} = -8 \div 15$  V.

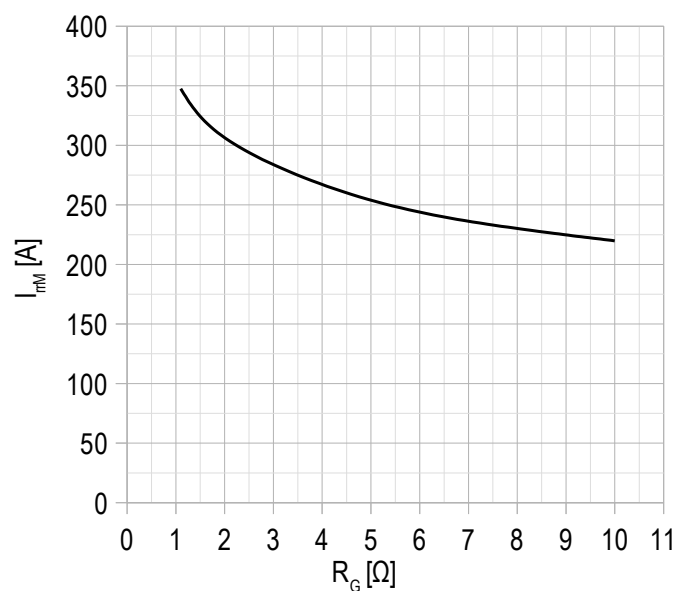
**Chart 16 – typ. reverse recovery current vs gate resistance FRD.**

$V_{CE} = 600$  V;  
 $V_{GE} = \pm 15$  V;  
 $L = 56$  nH;  
 $T_{vj\ (max)} = 150^\circ\text{C}$ .

Chart 17 – max. rated current vs frequency.

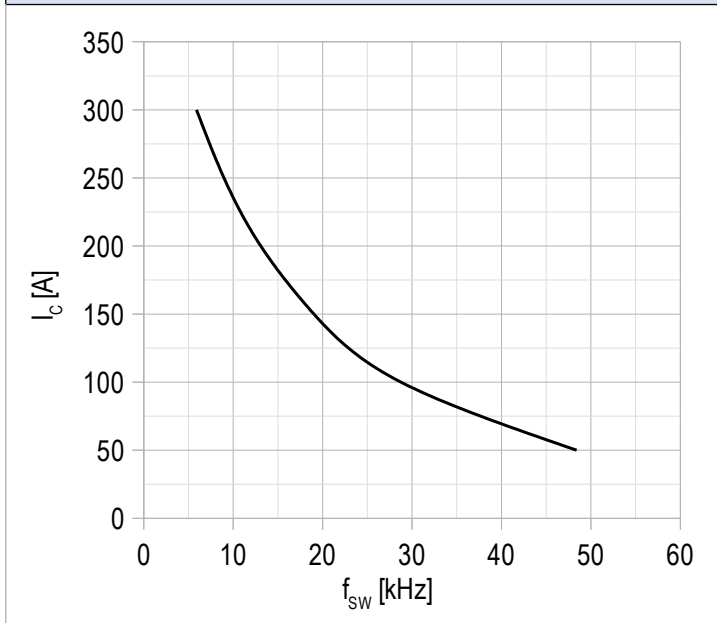

Duty cycle 50%;  
 $V_{CE} = 600 \text{ V}$ ;  
 $T_c = 80 \text{ }^\circ\text{C}$ ;  
 $T_{vj(max)} = 175 \text{ }^\circ\text{C}$ .

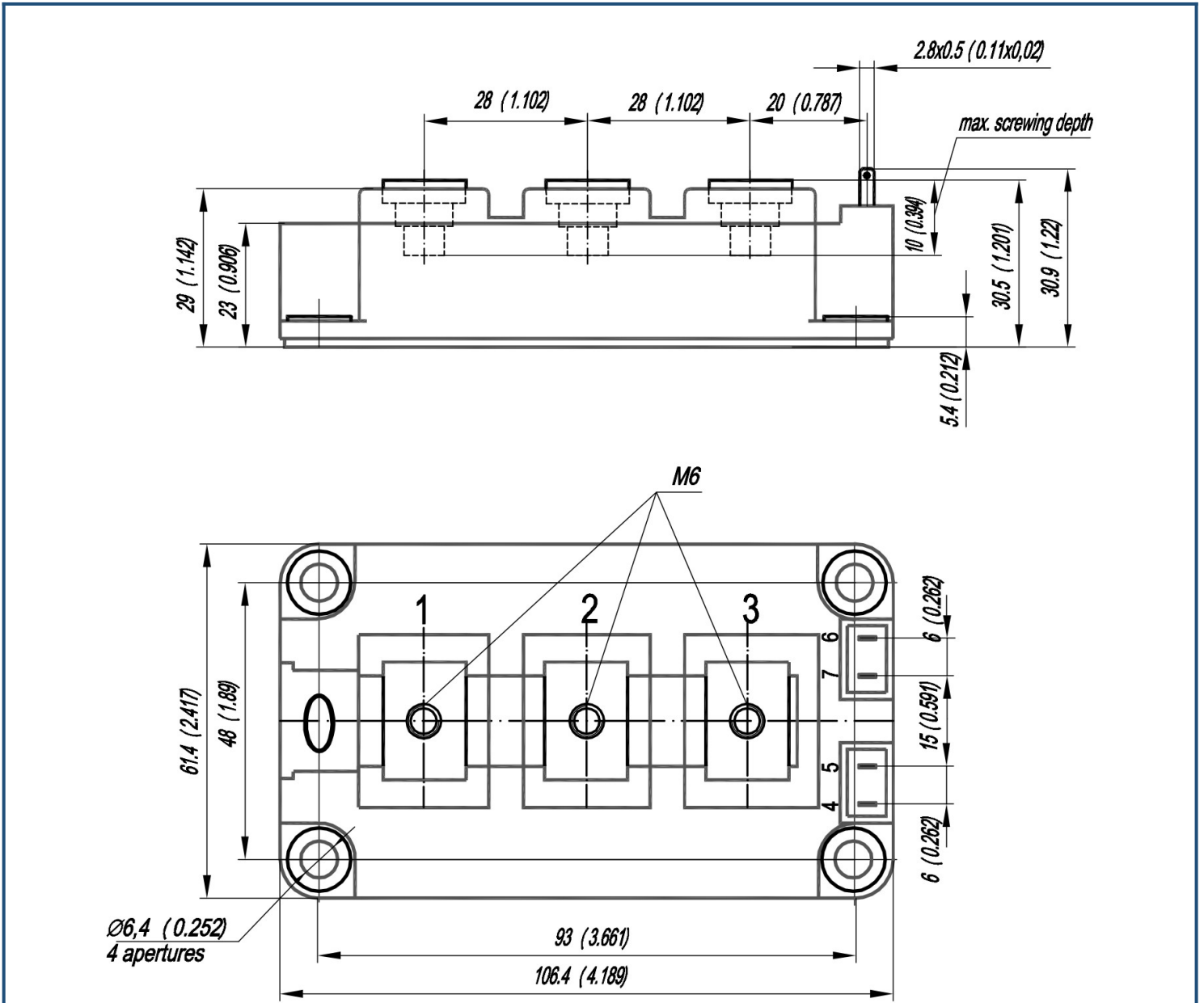

**Overall dimensions: Package type – AA**

**Part numbering guide**

MIAA	-	HB	12	FA	-	300	N	
MIAA								IGBT module package type: FA
		HB						2 switches as Half-Bridge
		HC						1 switch as High-Side chopper
		LC						1 switch as Low-Side chopper
			12					Voltage rating ( $V_{CES}/100$ )
				FA				IGBT+FRD chipset modification
						300		Current Rating
							N	Climatic version: normal climate

The information contained herein is protected by Copyright. In the interest of product improvement, Proton-Electrotex reserves the right to change datasheet without notice.