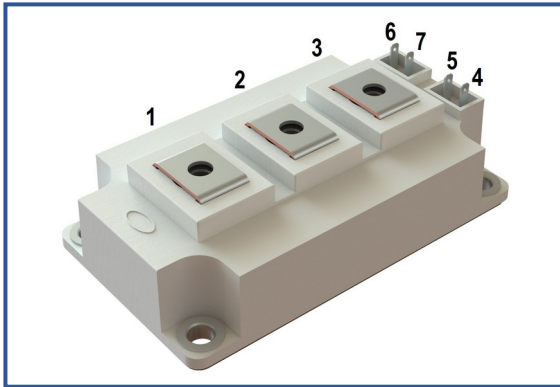

Industry standard 62mm IGBT module

1200 V 400 A

Chip features

- IGBT chip
 - Trench FS
 - low $V_{CE(sat)}$ value
 - 10 μ s short circuit of 150°C
 - square RBSOA of 2xl_c
 - low EMI
- FRD chip
 - fast and soft reverse recovery
 - low voltage drop

Design features

- copper baseplate
- Al₂O₃ DBC substrate
- ultrasonically welded power terminals
- Improved thermal cycling
- RoHS compliant

Typical application

- AC motor drives
- solar inverter
- air conditioning
- high power converters and UPS

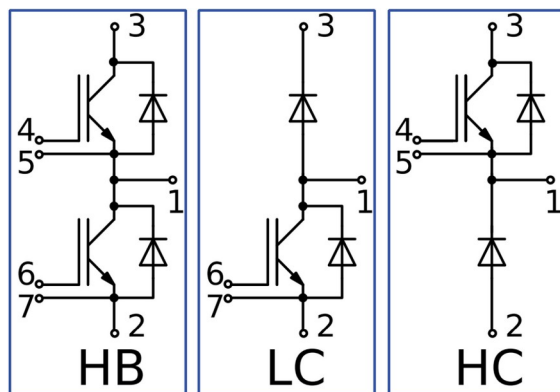
Maximum rated values

Definition	Symbol	Conditions	Value	Unit
IGBT				
Collector-Emitter voltage	V_{CES}	$V_{GE} = 0$.	1200	V
Collector current (nominal)	$I_{C\ nom}$		400	A
Collector current (maximum continuous)	$I_{C\ 25}$	$T_{vj\ (max)} = 175^{\circ}C; T_c = 25^{\circ}C$.	504	A
	$I_{C\ 80}$	$T_{vj\ (max)} = 175^{\circ}C; T_c = 80^{\circ}C$.	400	A
Repetitive peak collector current* ¹	I_{CRM}	$I_{CRM} = 3 \times I_{C\ nom}; t_p = 1\ ms$.	1200	A
Short-circuit duration	t_{psc}	$T_{vj} = 25^{\circ}C; V_{GE} = \pm 15\ V; V_{CE} = 720\ V;$ $R_{G\ on} = R_{G\ off} = 2.2\ \Omega; I_{C\ max} < 1950\ A$.	10	μ s
		$T_{vj} = 150^{\circ}C; V_{GE} = \pm 15\ V; V_{CE} = 720\ V;$ $R_{G\ on} = R_{G\ off} = 2.2\ \Omega; I_{C\ max} < 1900\ A$.	10	
Gate-Emitter voltage	V_{GES}		± 20	V
Junction operating temperature	$T_{vj\ (op)}$		-40...+150	°C
Inverse diode \ Freewheeling diode				
Repetitive peak reverse voltage	V_{RRM}	$V_{GE} = 0\ V$.	1200	V
Forward current (nominal)	$I_{F\ nom}$		400	A
Forward current (maximum continuous)	$I_{F\ 25}$	$T_{vj\ (max)} = 175^{\circ}C; T_c = 25^{\circ}C$.	444	A
	$I_{F\ 80}$	$T_{vj\ (max)} = 175^{\circ}C; T_c = 80^{\circ}C$.	332	A
Repetitive peak forward current* ¹	I_{FRM}	$I_{FRM} = 3 \times I_{F\ nom}; t_p = 1\ ms$.	1200	A
Junction operating temperature	$T_{vj\ (op)}$		-40...+150	°C
Module				
Storage temperature	T_{stg}		-55...+50	°C
Isolation voltage	V_{isol}	AC sin 50 Hz; t = 1 min.	4000	V

*¹ Pulse width and repetition rate should be such that device junction temperature does not exceed maximum T_{vj} rating

Characteristics

Definition	Symbol	Conditions	Value			Unit		
			min.	typ.	max.			
IGBT								
Collector-Emitter saturation voltage	V_{CEsat}	$V_{GE} = +15\text{ V}; I_C = 400\text{ A}; t_u = 1000\ \mu\text{s}.$	$T_{vj} = 25^\circ\text{C}$	1.93	1.97	2.12	V	
			$T_{vj} = 150^\circ\text{C}$	2.54	2.72	3.00	V	
Gate-Emitter threshold voltage	$V_{GE(th)}$	$I_C = 16\text{ mA}; V_{CE} = V_{GE}; T_{vj} = 25^\circ\text{C}; t_u = 2\text{ ms}.$		5.45	6.04	6.40	V	
Collector-Emitter cut-off current	I_{CES}	$V_{CE} = 1200\text{ V}; t_u = 10\text{ ms}; V_{GE} = 0.$	$T_{vj} = 25^\circ\text{C}$	45.5	63.2	300	μA	
			$T_{vj} = 150^\circ\text{C}$	1.99	2.11	5.0	mA	
Gate-Emitter leakage current	I_{GES}	$V_{CE} = 0; V_{GE} = \pm 20\text{ V}; T_{vj} = 25^\circ\text{C}; t_u = 30\text{ ms}.$		9.92	11.9	400	nA	
Input capacitance	C_{ies}	$V_{CE} = 10\text{ V}; V_{GE} = 0\text{ V}; f = 1\text{ MHz}; T_{vj} = 25^\circ\text{C}.$		-	33.2	-	nF	
Output capacitance	C_{oes}			-	2.40	-	nF	
Reverse transfer capacitance	C_{res}			-	2.80	-	nF	
Total gate charge	Q_G	$I_C = 400\text{ A}; V_{CE} = 600\text{ V}; V_{GE} = -8 \div 15\text{ V}.$		-	3416	3654	nC	
Internal gate resistance	R_{Gint}	$T_{vj} = 25^\circ\text{C}.$		-	1.88	-	Ω	
Turn-on delay time	$t_{d(on)}$	$V_{CE} = 600\text{ V}; V_{GE} = \pm 15\text{ V}; I_{Cmax} = 400\text{ A}; R_G = 2.2\ \Omega; L = 56\text{ nH}.$	$T_{vj} = 25^\circ\text{C}$	348	387	480	ns	
			$T_{vj} = 150^\circ\text{C}$	440	457	590		
Rise time	t_{ri}		$T_{vj} = 25^\circ\text{C}$	78	83	100	ns	
			$T_{vj} = 150^\circ\text{C}$	71	74	110		
Turn-on energy	E_{on}		$T_{vj} = 25^\circ\text{C}$	16.8	21.0	30.0	mJ	
			$T_{vj} = 150^\circ\text{C}$	23.2	27.9	47.0		
Turn-off delay time	$t_{d(off)}$		$T_{vj} = 25^\circ\text{C}$	650	666	770	ns	
			$T_{vj} = 150^\circ\text{C}$	640	650	980		
Fall time	t_{fi}		$T_{vj} = 25^\circ\text{C}$	181	194	260	ns	
			$T_{vj} = 150^\circ\text{C}$	287	314	360		
Turn-off energy	E_{off}		$T_{vj} = 25^\circ\text{C}$	40.8	41.3	47.0	mJ	
			$T_{vj} = 150^\circ\text{C}$	52.1	53.9	61.0		
Collector-emitter threshold voltage	V_{CE0}	$V_{GE} = +15\text{ V}; T_{vj} = 150^\circ\text{C}; I_{CE1} = 100\text{ A}; I_{CE2} = 400\text{ A}; t_u = 1000\ \mu\text{s}.$		0.82	0.84	0.86	V	
On-State slope resistance (IGBT)	r_{CE0}			4.27	4.69	5.30	m Ω	
Thermal resistance junction to case	$R_{th(j-c)}$	$\text{DC}; I_{CE} = 400 \pm 20\text{ A}; I_{test} = 1.0\text{ A}; V_{GE} = +15\text{ V}.$		-	0.073	0.092	K/W	
Inverse diode \ Freewheeling diode								
Forward voltage drop	V_F	$I_F = 400\text{ A}; V_{GE} = 0; t_u = 500\ \mu\text{s}.$	$T_{vj} = 25^\circ\text{C}$	1.94	1.98	2.15	V	
			$T_{vj} = 150^\circ\text{C}$	2.17	2.31	2.59	V	
Reverse recovery time	t_{rr}	$V_{GE} = \pm 15\text{ V}; V_{CE} = 600\text{ V}; I_{Cmax} = 400\text{ A}; L = 56\text{ nH}; R_{Gon} = 2.2\ \Omega.$	$T_{vj} = 25^\circ\text{C}$	136	142	170	ns	
			$T_{vj} = 150^\circ\text{C}$	207	221	340	ns	
Peak reverse recovery current	I_{rrM}		$T_{vj} = 25^\circ\text{C}$	260	276	320	A	
			$T_{vj} = 150^\circ\text{C}$	320	340	390	A	
Reverse recovered charge	Q_{rr}		$T_{vj} = 25^\circ\text{C}$	21.0	23.0	29.0	μC	
			$T_{vj} = 150^\circ\text{C}$	40.0	43.0	65.0	μC	
Reverse recovery energy	E_{rec}		$T_{vj} = 25^\circ\text{C}$	11.0	13.0	20.0	mJ	
			$T_{vj} = 150^\circ\text{C}$	29.0	31.0	36.0	mJ	
Threshold voltage	$V_{(T0)}$		$T_{vj} = 150^\circ\text{C}; V_{GE} = 0; I_{CE1} = 100\text{ A}; I_{CE2} = 400\text{ A}; t_u = 1000\ \mu\text{s}.$		0.81	0.82	0.85	V
Forward slope resistance	r_T				2.60	2.67	3.00	m Ω
Thermal resistance junction to case	$R_{th(jc-D)}$		$\text{DC}; I_{CE} = 330 \pm 20\text{ A}; I_{test} = 1.0\text{ A}; V_{GE} = +15\text{ V}.$		-	0.131	0.150	K/W

Module							
Pin resistance	R_{Pxy}	$T_{vj} = 25^{\circ}\text{C}.$	R_{P12}	-	0.28	0.50	m Ω
			R_{P13}	-	0.38	0.50	
Parasitic inductance between terminals	L_{Pce}			-	22	-	nH
Thermal resistance case to heatsink	R_{thCH}	per module			0.02	0.04	K/W
Mounting torque for screws to heatsink	M_s	to heatsink M6		3.00	-	5.00	N*m
Mounting torque for terminal screws	M_t	to terminals M6		2.25	2.50	2.75	N*m
Weight	W			-	320	340	g

Notes:

- Insulating material operating temperature 125°C max;
- Case temperature 125°C max;
- The recommended operating junction temperature $T_{vj\ op} = -40 \div +150^{\circ}\text{C}.$

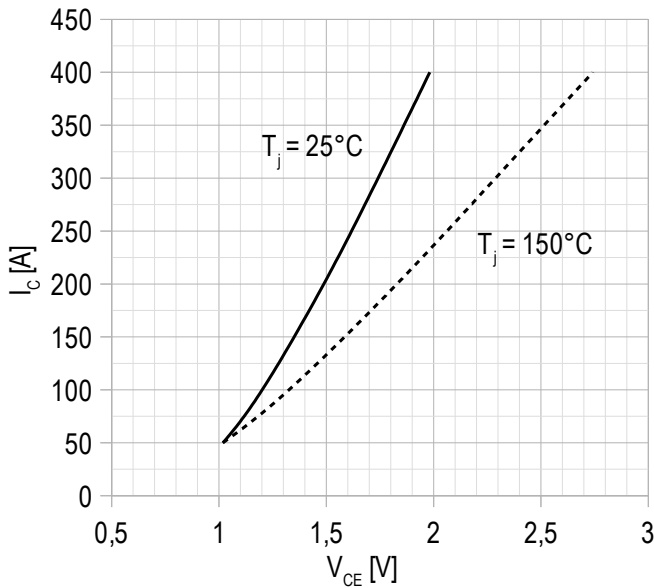
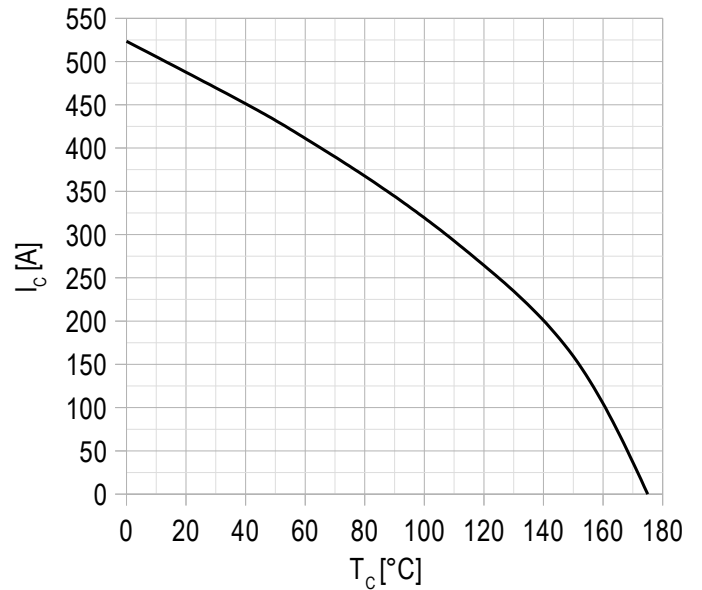
Chart 1 – typ. output characteristic, IGBT.

 $V_{GE} = +15 \text{ V.}$
Chart 2 – max. rated current vs temperature.

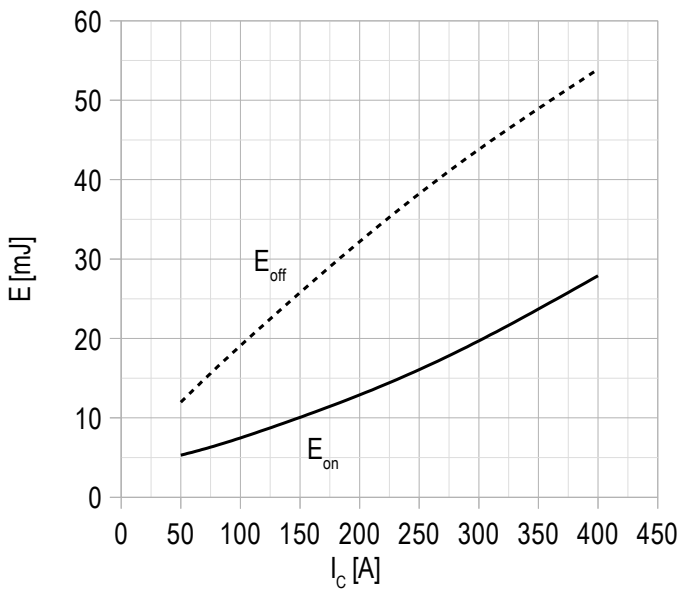
DC;
 $V_{GE} = +15 \text{ V;}$
 $T_{vj(max)} = 150^\circ\text{C.}$

Chart 3 – typ. turn-on/off energy vs rated current, IGBT.

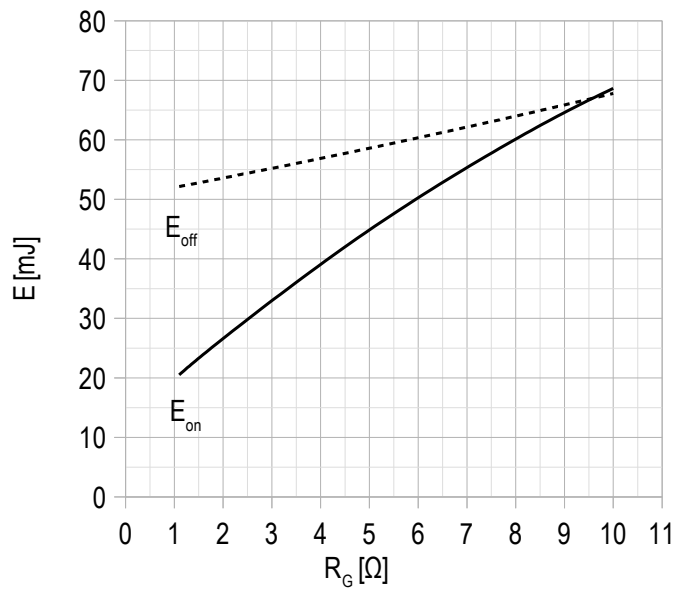
$V_{CE} = 600 \text{ V;}$
 $V_{GE} = \pm 15 \text{ V;}$
 $R_G = 2.2 \ \Omega;$
 $L = 56 \text{ nH;}$
 $T_{vj(max)} = 150^\circ\text{C.}$

Chart 4 – typ. turn-on/off energy vs gate resistance, IGBT.

$V_{CE} = 600 \text{ V;}$
 $V_{GE} = \pm 15 \text{ V;}$
 $I_{Cmax} = 400 \text{ A;}$
 $L = 56 \text{ nH;}$
 $T_{vj(max)} = 150^\circ\text{C.}$

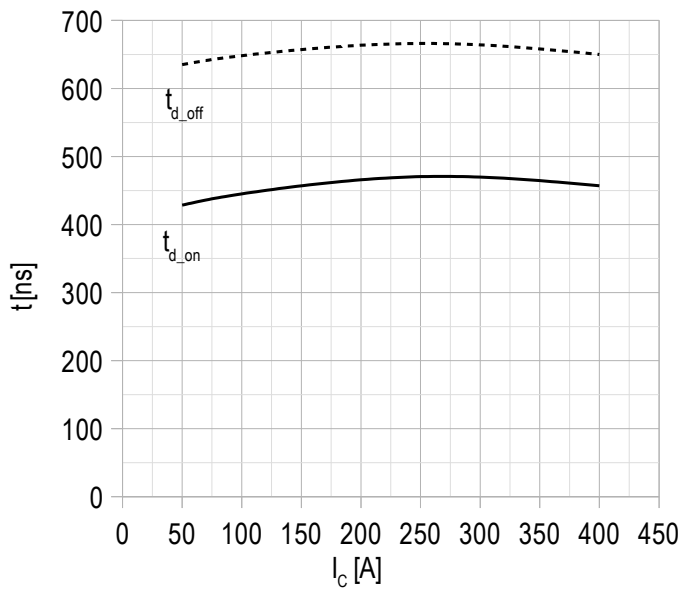
Chart 5 – typ. switching times vs rated current, IGBT.

$V_{CE} = 600 \text{ V};$
 $V_{GE} = \pm 15 \text{ V};$
 $R_G = 2.2 \ \Omega;$
 $L = 56 \text{ nH};$
 $T_{vj(max)} = 150^\circ\text{C}.$

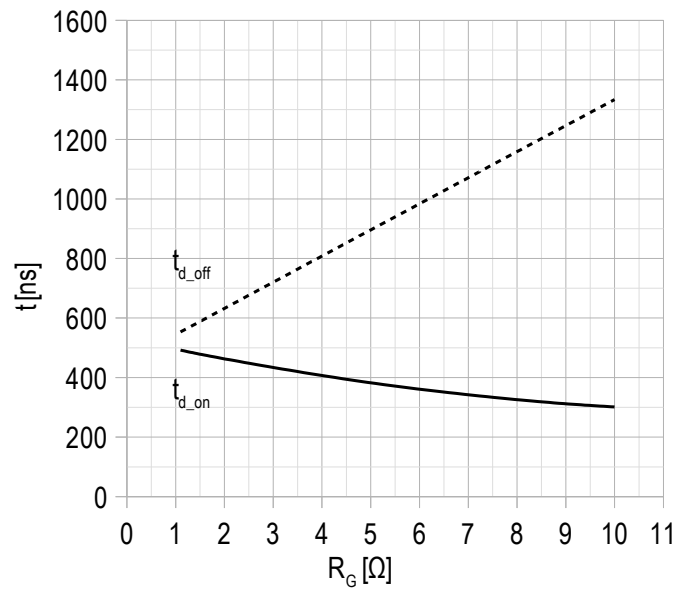
Chart 6 – typ. switching times vs gate resistance, IGBT.

$V_{CE} = 600 \text{ V};$
 $V_{GE} = \pm 15 \text{ V};$
 $I_{Cmax} = 400 \text{ A};$
 $L = 56 \text{ nH};$
 $T_{vj(max)} = 150^\circ\text{C}.$

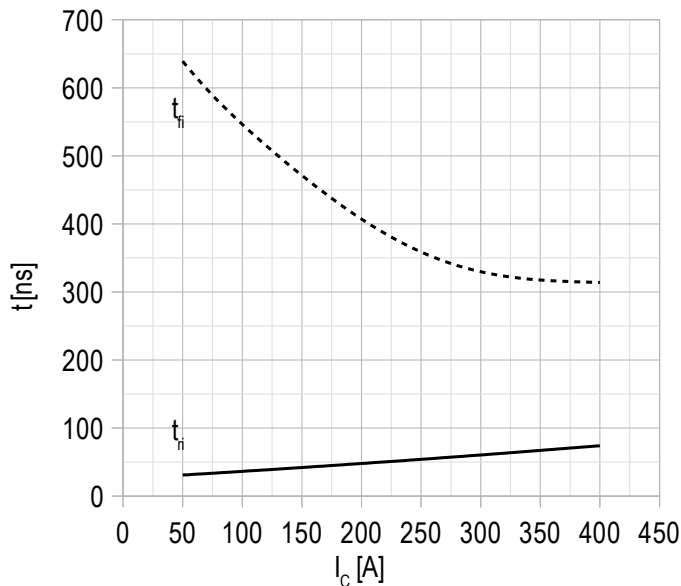
Chart 7 – typ. switching times vs rated current, IGBT.

$V_{CE} = 600 \text{ V};$
 $V_{GE} = \pm 15 \text{ V};$
 $R_G = 2.2 \ \Omega;$
 $L = 56 \text{ nH};$
 $T_{vj(max)} = 150^\circ\text{C}.$

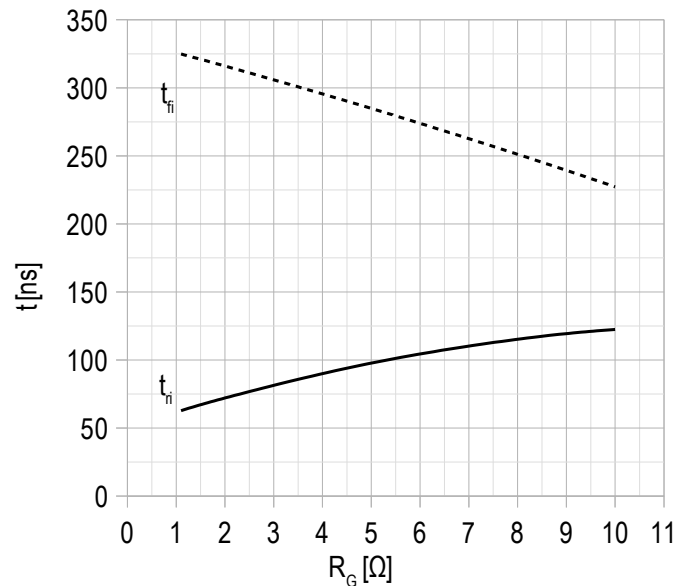
Chart 8 – typ. switching times vs gate resistance, IGBT.

$V_{CE} = 600 \text{ V};$
 $V_{GE} = \pm 15 \text{ V};$
 $I_{Cmax} = 400 \text{ A};$
 $L = 56 \text{ nH};$
 $T_{vj(max)} = 150^\circ\text{C}.$

Chart 9 – max. transient thermal impedance.

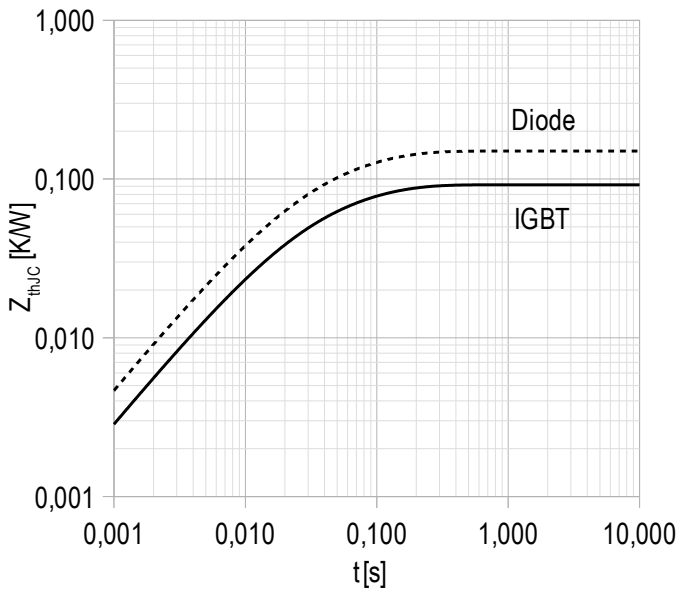

Single pulse;
 $V_{GE} = +15 \text{ V}$.

Chart 10 – RBSOA.

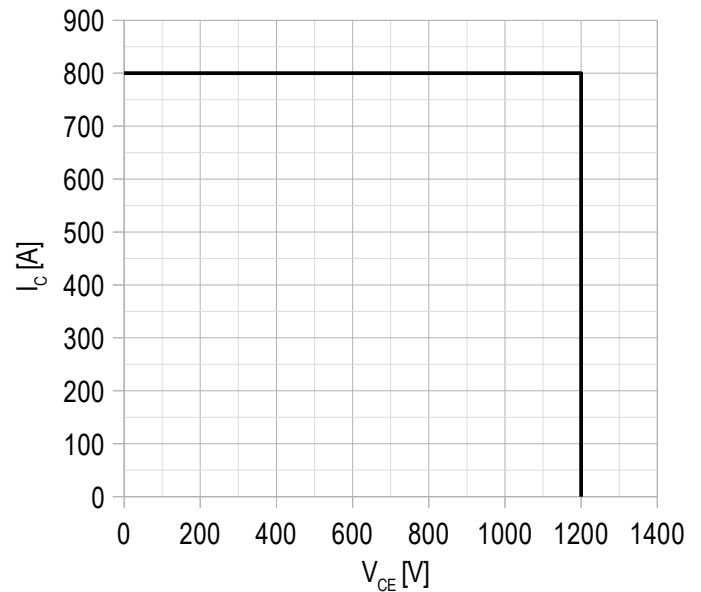

$V_{CE \text{ max}} = 1200 \text{ V}$;
 $V_{GE} = \pm 15 \text{ V}$;
 $I_{C \text{ max}} = 2 \cdot I_{C \text{ nom}}$;
 $R_G = 2.2 \ \Omega$;
 $L = 56 \text{ nH}$.

Chart 11 – typ. output characteristic, FRD.

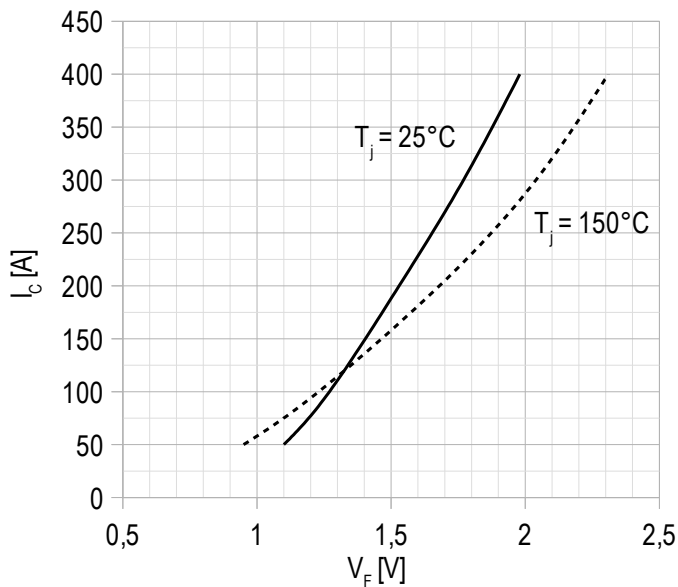

$V_{GE} = 0 \text{ V}$.

Chart 12 – typ. switching losses vs rated current, FRD.

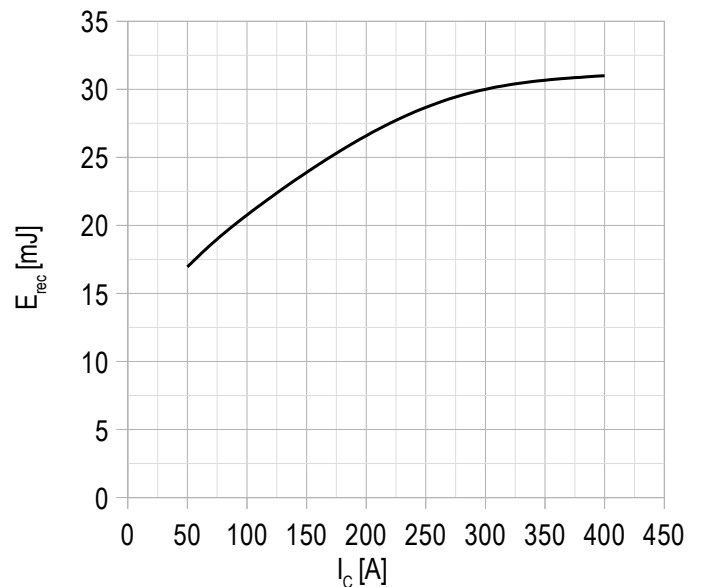

$V_{GE} = \pm 15 \text{ V}$;
 $V_{CE} = 600 \text{ V}$;
 $L = 56 \text{ nH}$;
 $R_{G \text{ on}} = 2.2 \ \Omega$;
 $T_{vj \text{ (max)}} = 150^\circ\text{C}$.

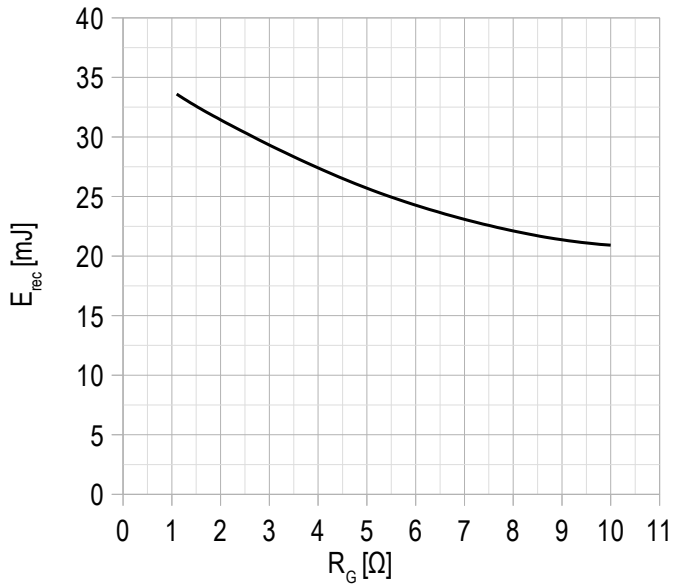
Chart 13 – typ. switching losses vs gate resistance, FRD.

$V_{GE} = \pm 15$ V;
 $V_{CE} = 600$ V;
 $I_{C\ max} = 400$ A;
 $L = 56$ nH;
 $T_{vj\ (max)} = 150^\circ$ C.

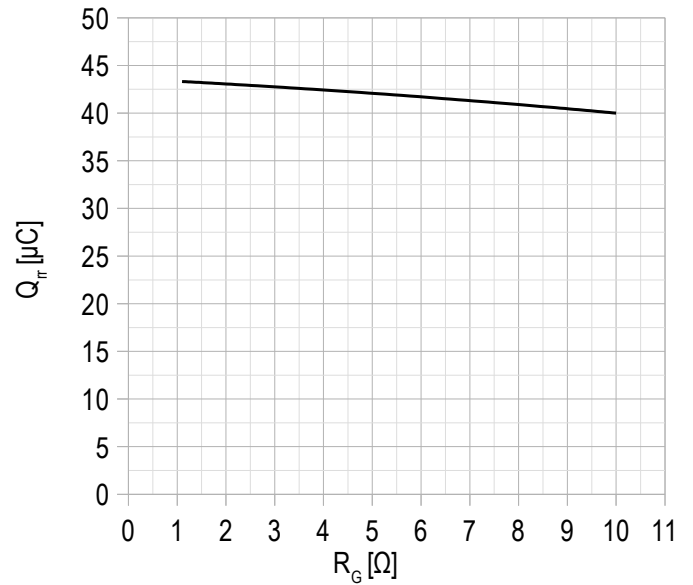
Chart 14 – typ. reverse recovered charge vs gate resistance, FRD.

$V_{GE} = \pm 15$ V;
 $V_{CE} = 600$ V;
 $I_{C\ max} = 400$ A;
 $L = 56$ nH;
 $T_{vj\ (max)} = 150^\circ$ C.

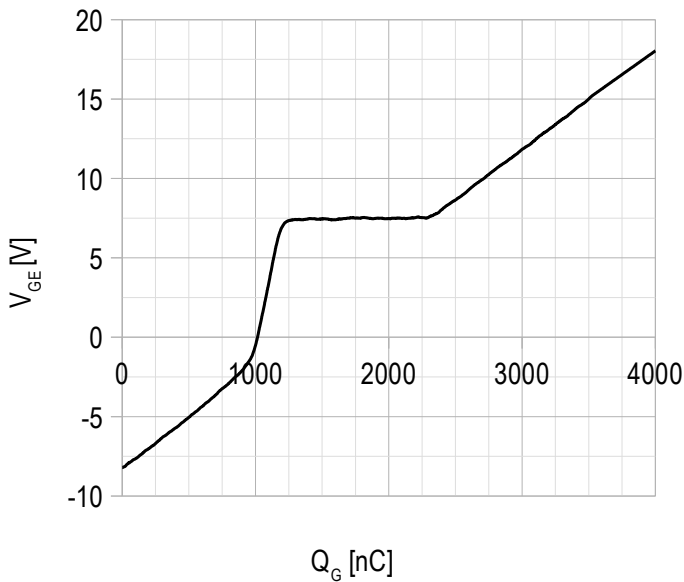
Chart 15 – typ. gate charge characteristic.

$I_C = 400$ A;
 $V_{CE} = 600$ V;
 $V_{GE} = -8 \div 15$ V.

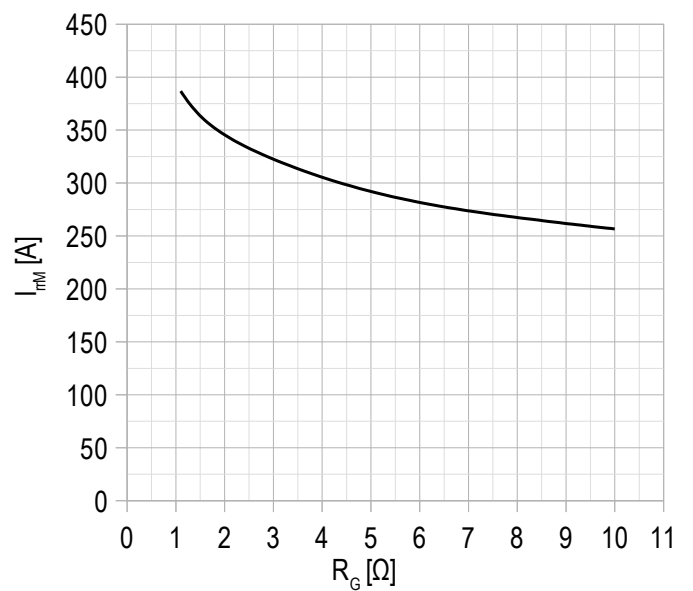
Chart 16 – typ. reverse recovery current vs gate resistance FRD.

$V_{CE} = 600$ V;
 $V_{GE} = \pm 15$ V;
 $L = 56$ nH;
 $T_{vj\ (max)} = 150^\circ$ C.

Chart 17 – max. rated current vs frequency.

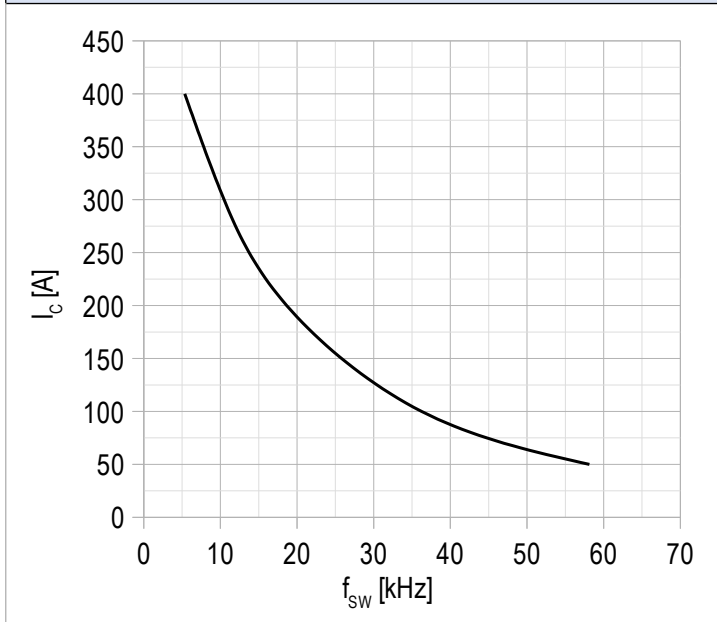

Duty cycle 50%;
 $V_{CE} = 600 \text{ V}$;
 $T_c = 80 \text{ }^\circ\text{C}$;
 $T_{vj(max)} = 175 \text{ }^\circ\text{C}$.

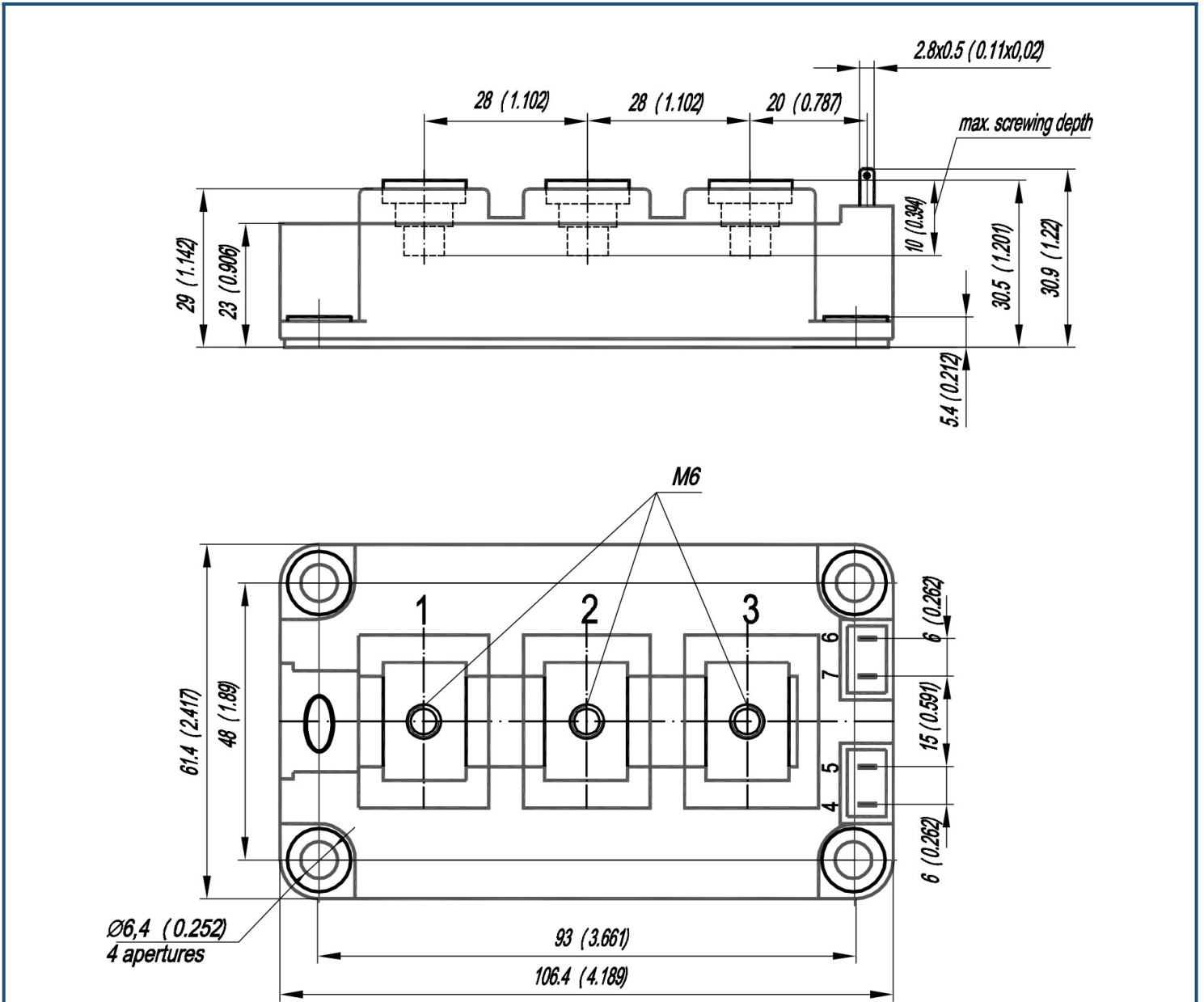
Overall dimensions: Package type – AA

Part numbering guide

MIAA	-	HB	12	FA	-	400	N	
MIAA								IGBT module package type: FA
		HB						2 switches as Half-Bridge
		HC						1 switch as High-Side chopper
		LC						1 switch as Low-Side chopper
			12					Voltage rating ($V_{CES}/100$)
				FA				IGBT+FRD chipset modification
						400		Current Rating
							N	Climatic version: normal climate

The information contained herein is protected by Copyright. In the interest of product improvement, Proton-Electrotex reserves the right to change datasheet without notice.