



Optimum power handling
Low on-state and switching losses
Designed for traction and industrial applications

Phase Control Stud Thyristor
Type T161-125-18

Mean on-state current	I_{TAV}										125 A							
Repetitive peak off-state voltage	V_{DRM}										100÷1800 V							
Repetitive peak reverse voltage	V_{RRM}																	
Turn-off time	t_q										125, 160, 200, 250, 320, 400, 500 μs							
V_{DRM}, V_{RRM}, V	100	200	300	400	500	600	700	800	900	1000	1100	1200	1300	1400	1500	1600	1800	
Voltage code	1	2	3	4	5	6	7	8	9	10	11	12	13	14	15	16	18	
$T_j, ^\circ C$	-60÷125																	

MAXIMUM ALLOWABLE RATINGS

Symbols and parameters		Units	Values	Test conditions
ON-STATE				
I_{TAV}	Mean on-state current	A	125 183	$T_c = 101^\circ C$; $T_c = 85^\circ C$; 180° half-sine wave; 50 Hz
I_{TRMS}	RMS on-state current	A	196	$T_c = 101^\circ C$; 180° half-sine wave; 50 Hz
I_{TSM}	Surge on-state current	kA	4.0 4.5	$T_j = T_{jmax}$ $T_j = 25^\circ C$ 180° half-sine wave; $t_p = 10$ ms; single pulse; $V_D = V_R = 0$ V; Gate pulse: $I_G = 2$ A; $t_{GP} = 50 \mu s$; $di_G/dt \geq 1$ A/ μs
			4.0 4.5	$T_j = T_{jmax}$ $T_j = 25^\circ C$ 180° half-sine wave; $t_p = 8.3$ ms; single pulse; $V_D = V_R = 0$ V; Gate pulse: $I_G = 2$ A; $t_{GP} = 50 \mu s$; $di_G/dt \geq 1$ A/ μs
I^2t	Safety factor	$A^2s \cdot 10^3$	80 100	$T_j = T_{jmax}$ $T_j = 25^\circ C$ 180° half-sine wave; $t_p = 10$ ms; single pulse; $V_D = V_R = 0$ V; Gate pulse: $I_G = 2$ A; $t_{GP} = 50 \mu s$; $di_G/dt \geq 1$ A/ μs
			60 80	$T_j = T_{jmax}$ $T_j = 25^\circ C$ 180° half-sine wave; $t_p = 8.3$ ms; single pulse; $V_D = V_R = 0$ V; Gate pulse: $I_G = 2$ A; $t_{GP} = 50 \mu s$; $di_G/dt \geq 1$ A/ μs
BLOCKING				
V_{DRM}, V_{RRM}	Repetitive peak off-state and Repetitive peak reverse voltages	V	100÷1800	$T_{jmin} < T_j < T_{jmax}$; 180° half-sine wave; 50 Hz; Gate open
V_{DSM}, V_{RSM}	Non-repetitive peak off-state and Non-repetitive peak reverse voltages	V	110÷1900	$T_{jmin} < T_j < T_{jmax}$; 180° half-sine wave; single pulse; Gate open
V_D, V_R	Direct off-state and Direct reverse voltages	V	$0.6 \cdot V_{DRM}$ $0.6 \cdot V_{RRM}$	$T_j = T_{jmax}$; Gate open

TRIGGERING				
I_{FGM}	Peak forward gate current	A	5	$T_j = T_{j\ max}$
V_{RGM}	Peak reverse gate voltage	V	5	
P_G	Gate power dissipation	W	3	$T_j = T_{j\ max}$ for DC gate current
SWITCHING				
$(di_T/dt)_{crit}$	Critical rate of rise of on-state current non-repetitive (f=1 Hz)	A/ μ s	800	$T_j = T_{j\ max}$; $V_D = 0.67 \cdot V_{DRM}$; $I_{TM} = 640$ A; Gate pulse: $I_G = 2$ A; $t_{GP} = 50$ μ s; $di_G/dt \geq 2$ A/ μ s
THERMAL				
T_{stg}	Storage temperature	$^{\circ}$ C	-60÷50	
T_j	Operating junction temperature	$^{\circ}$ C	-60÷125	
MECHANICAL				
M	Tightening torque	Nm	20÷30	
a	Acceleration	m/s ²	100	

CHARACTERISTICS

Symbols and parameters		Units	Values	Conditions		
ON-STATE						
V_{TM}	Peak on-state voltage, max	V	1.45	$T_j = 25$ $^{\circ}$ C; $I_{TM} = 393$ A		
$V_{T(TO)}$	On-state threshold voltage, max	V	0.867	$T_j = T_{j\ max}$;		
r_T	On-state slope resistance, max	m Ω	1.300	$0.5 \pi I_{TAV} < I_T < 1.5 \pi I_{TAV}$		
I_L	Latching current, max	mA	500	$T_j = 25$ $^{\circ}$ C; $V_D = 12$ V; Gate pulse: $I_G = 2$ A; $t_{GP} = 50$ μ s; $di_G/dt \geq 1$ A/ μ s		
I_H	Holding current, max	mA	250	$T_j = 25$ $^{\circ}$ C; $V_D = 12$ V; Gate open		
BLOCKING						
I_{DRM}, I_{RRM}	Repetitive peak off-state and Repetitive peak reverse currents, max	mA	50	$T_j = T_{j\ max}$; $V_D = V_{DRM}$; $V_R = V_{RRM}$		
$(dv_D/dt)_{crit}$	Critical rate of rise of off-state voltage ¹⁾ , min	V/ μ s	200, 320, 500, 1000	$T_j = T_{j\ max}$; $V_D = 0.67 \cdot V_{DRM}$; Gate open		
TRIGGERING						
V_{GT}	Gate trigger direct voltage, max	V	3.00	$T_j = T_{j\ min}$ $T_j = 25$ $^{\circ}$ C	$V_D = 12$ V; $I_D = 3$ A; Direct gate current	
			2.50			
I_{GT}	Gate trigger direct current, max	mA	1.50	$T_j = T_{j\ max}$		
			400			$T_j = T_{j\ min}$ $T_j = 25$ $^{\circ}$ C
			250			
150	$T_j = T_{j\ max}$					
V_{GD}	Gate non-trigger direct voltage, min	V	0.70	$T_j = T_{j\ max}$; $V_D = 0.67 \cdot V_{DRM}$;		
I_{GD}	Gate non-trigger direct current, min	mA	65.00	Direct gate current		
SWITCHING						
t_{gd}	Delay time, max	μ s	1.10	$T_j = 25$ $^{\circ}$ C; $V_D = 1000$ V; $I_{TM} = I_{TAV}$; $di/dt = 200$ A/ μ s;		
t_{gt}	Turn-on time, max	μ s	3.00	Gate pulse: $I_G = 2$ A; $V_G = 20$ V; $t_{GP} = 50$ μ s; $di_G/dt = 2$ A/ μ s		
t_q	Turn-off time ²⁾ , max	μ s	125, 160, 200, 250, 320, 400, 500	$dv_D/dt = 50$ V/ μ s; $T_j = T_{j\ max}$; $I_{TM} = I_{TAV}$; $di_R/dt = -10$ A/ μ s; $V_R = 100$ V; $V_D = 0.67 \cdot V_{DRM}$		
Q_{rr}	Total recovered charge, max	μ C	725	$T_j = T_{j\ max}$; $I_{TM} = 125$ A;		
t_{rr}	Reverse recovery time, max	μ s	17	$di_R/dt = -10$ A/ μ s;		
I_{rrM}	Peak reverse recovery current, max	A	85	$V_R = 100$ V		

THERMAL				
R_{thjc}	Thermal resistance, junction to case, max	$^{\circ}\text{C}/\text{W}$	0.1500	Direct current
MECHANICAL				
w	Weight, max	g	260	
D_s	Surface creepage distance	mm (inch)	12.40 (4.882)	
D_a	Air strike distance	mm (inch)	12.40 (4.882)	

PART NUMBERING GUIDE							NOTES							
T	161	125	18	A2	E2	N	1) Critical rate of rise of off-state voltage							
1	2	3	4	5	6	7	Symbol of Group	P2	K2	E2	A2			
1. Phase Control Thyristor							$(dv_D/dt)_{crit}$, V/ μs	200	320	500	1000			
2. Design version							2) Turn-off time ($dv_D/dt=50$ V/ μs)							
3. Mean on-state current, A							Symbol of Group	X2	T2	P2	M2	K2	H2	E2
4. Voltage code							t_{qr} , μs	125	160	200	250	320	400	500
5. Critical rate of rise of off-state voltage, V/ μs														
6. Turn-off time ($dv_D/dt=50$ V/ μs)														
7. Ambient conditions: N – normal; T – tropical														

OVERALL DIMENSIONS

Package type: T.SA1

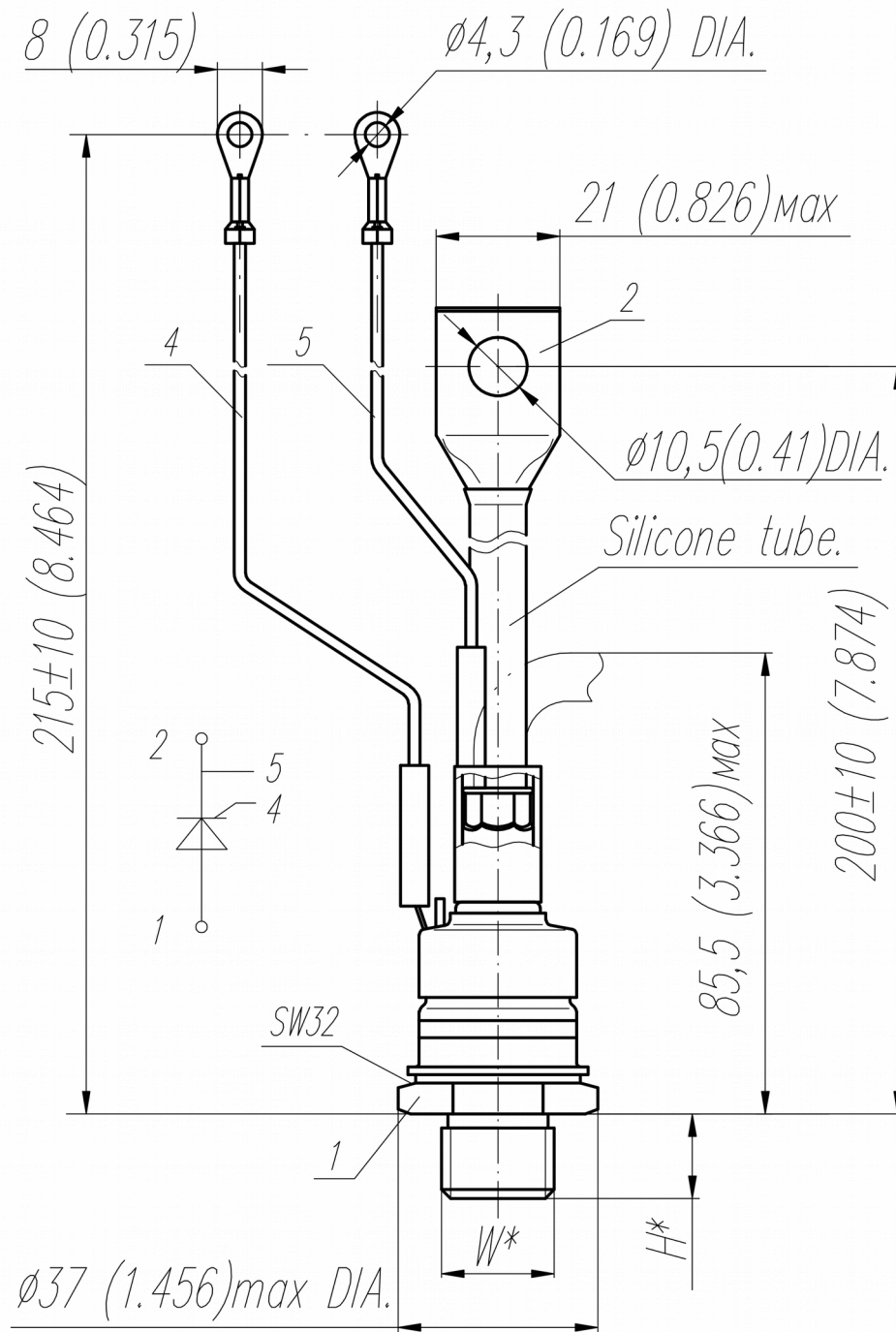

Type of screw	W	H
Metric Screw Type A (upon request)	M16x1,5 – 8g	13
Metric Screw Type B	M20x1,5 – 8g	15

Polarity	Example of code designation	Reference designation	Colors		
			Anode	Cathode	Gate
Anode to stud	T161-125-18		-	Red tube	White

All dimensions in millimeters (inches)

The information contained herein is confidential and protected by Copyright. In the interest of product improvement, Proton-Electrotex reserves the right to change data sheet without notice.

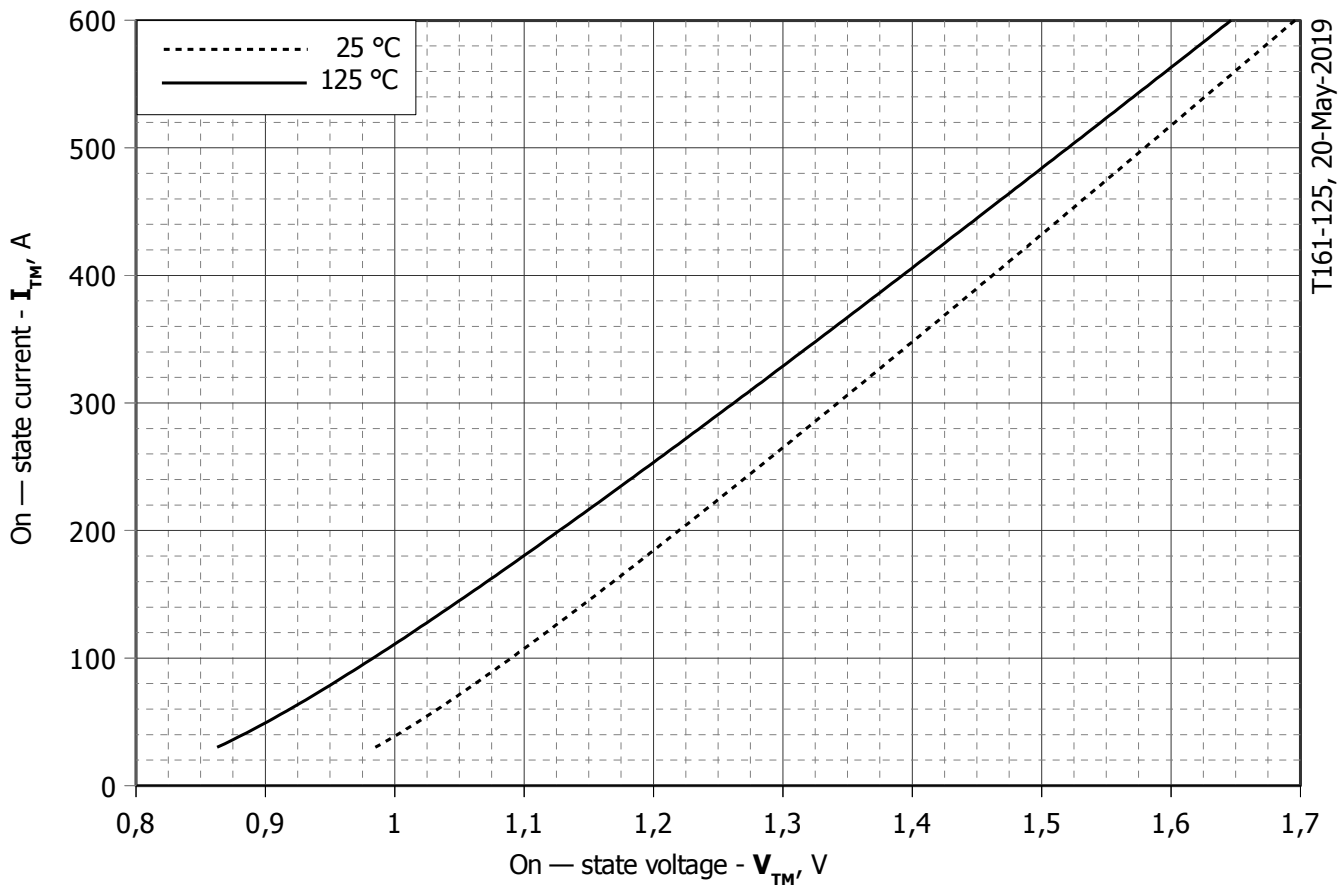

Fig 1 – On-state characteristics of Limit device

Analytical function for On-state characteristic:

$$V_T = A + B \cdot i_T + C \cdot \ln(i_T + 1) + D \cdot \sqrt{i_T}$$

	Coefficients for max curves	
	$T_j = 25^\circ\text{C}$	$T_j = T_{j\text{max}}$
A	0.8933621	0.7421653
B	0.0010594	0.0011377
C	0.0112604	0.0184158
D	0.0038705	0.0042410

On-state characteristic model (see Fig. 1)

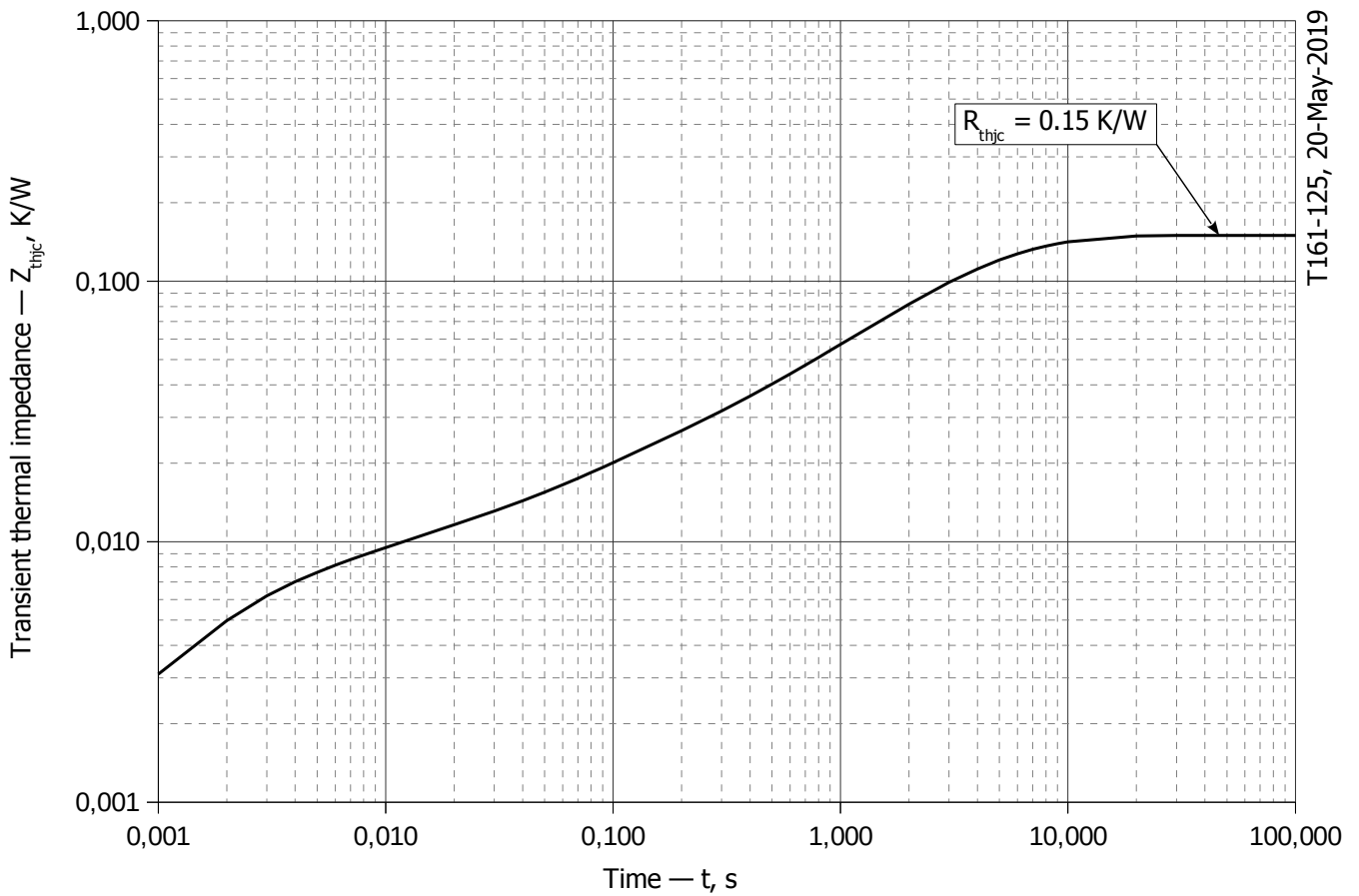

T161-125, 20-May-2019

Fig 2 – Transient thermal impedance Z_{thjc} vs. time t

Analytical function for Transient thermal impedance junction to case Z_{thjc} for DC:

$$Z_{thjc} = \sum_{i=1}^n R_i \left(1 - e^{-\frac{t}{\tau_i}} \right)$$

Where $i = 1$ to n , n is the number of terms in the series.

t = Duration of heating pulse in seconds.

Z_{thjc} = Thermal resistance at time t .

R_i = Amplitude of p_{th} term.

τ_i = Time constant of r_{th} term.

DC

i	1	2	3	4	5	6
R_i, K/W	0.07504	0.0516	0.007369	0.006977	0.003512	0.005502
τ_i, s	4.409	2.183	0.3382	0.07307	0.008189	0.001615

Transient thermal impedance junction to case Z_{thjc} model (see Fig. 2)

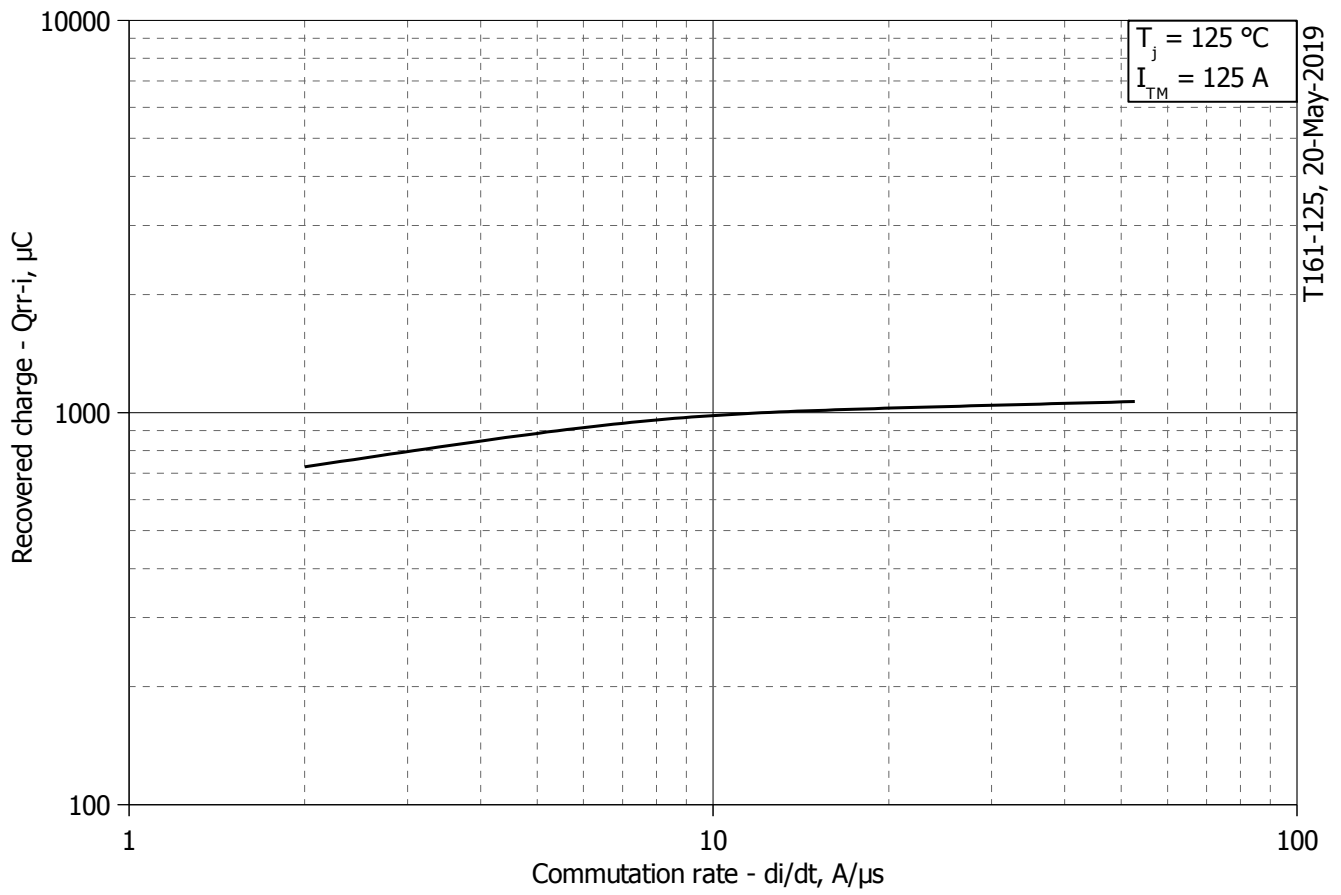

Fig 3 – Maximum recovered charge Q_{rr-i} (integral) vs. commutation rate di_R/dt

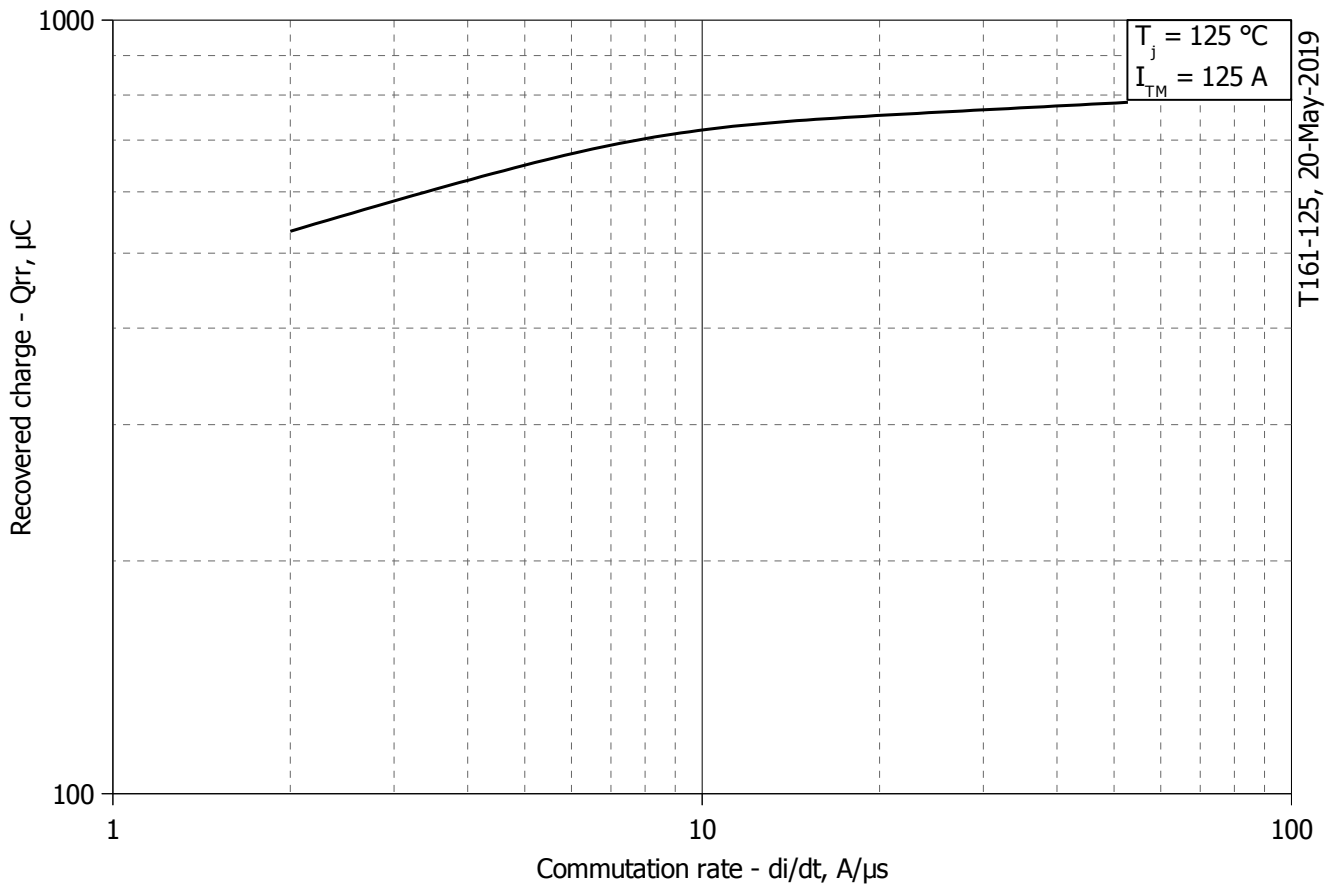

Fig 4 – Maximum recovered charge Q_{rr} vs. commutation rate di_R/dt (25% chord)

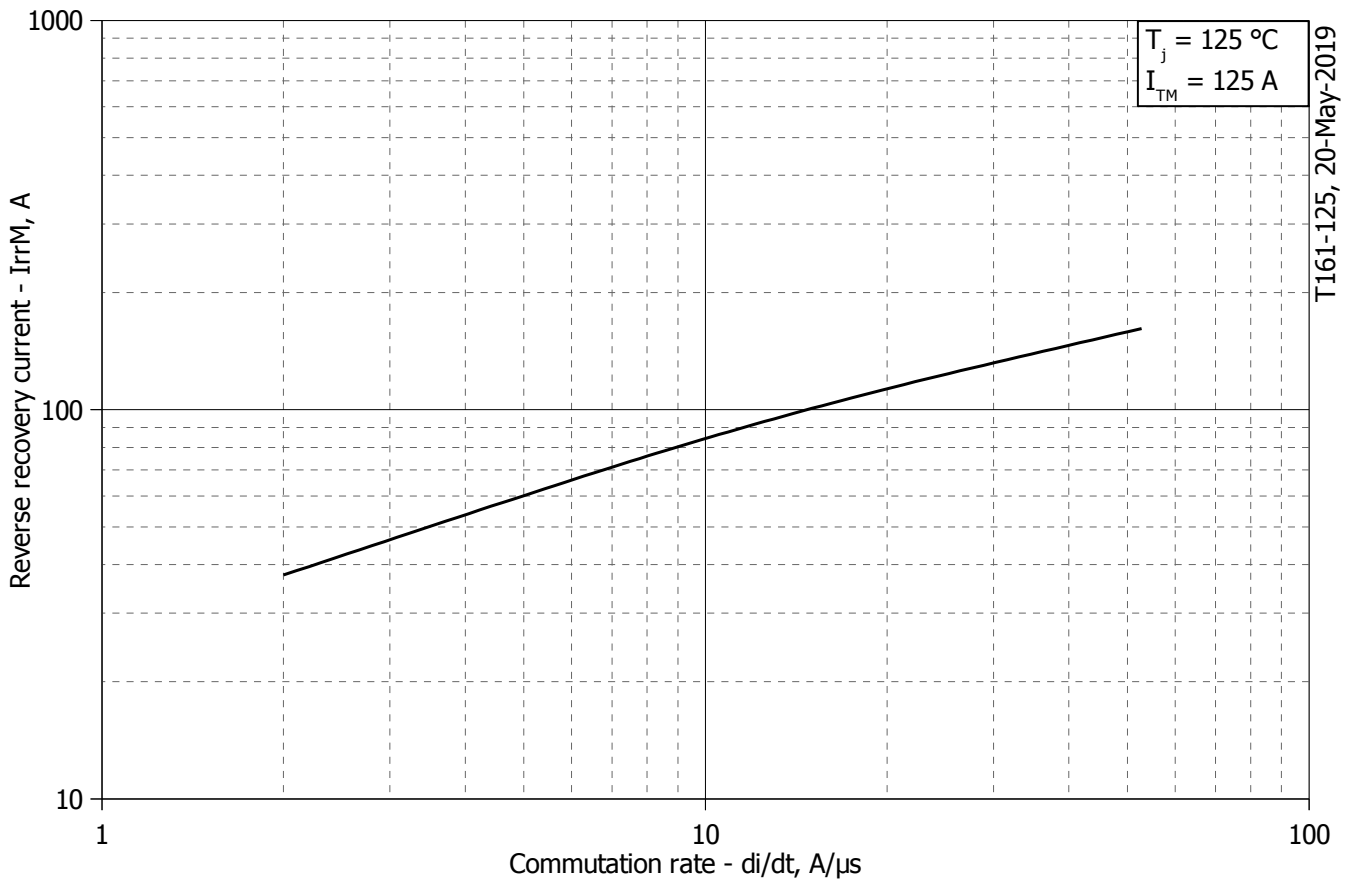

Fig 5 – Maximum reverse recovery current I_{rrM} vs. commutation rate di_R/dt

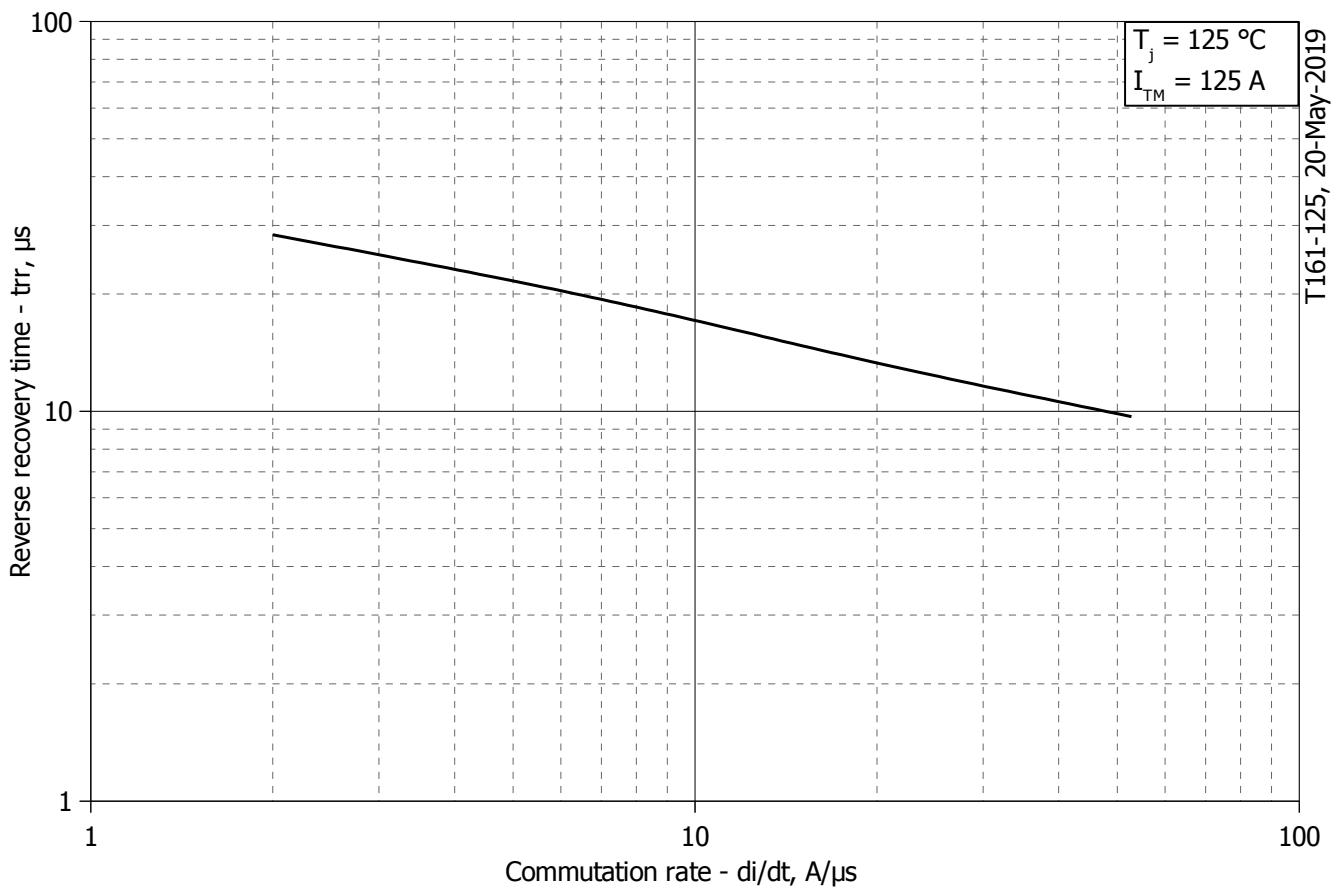
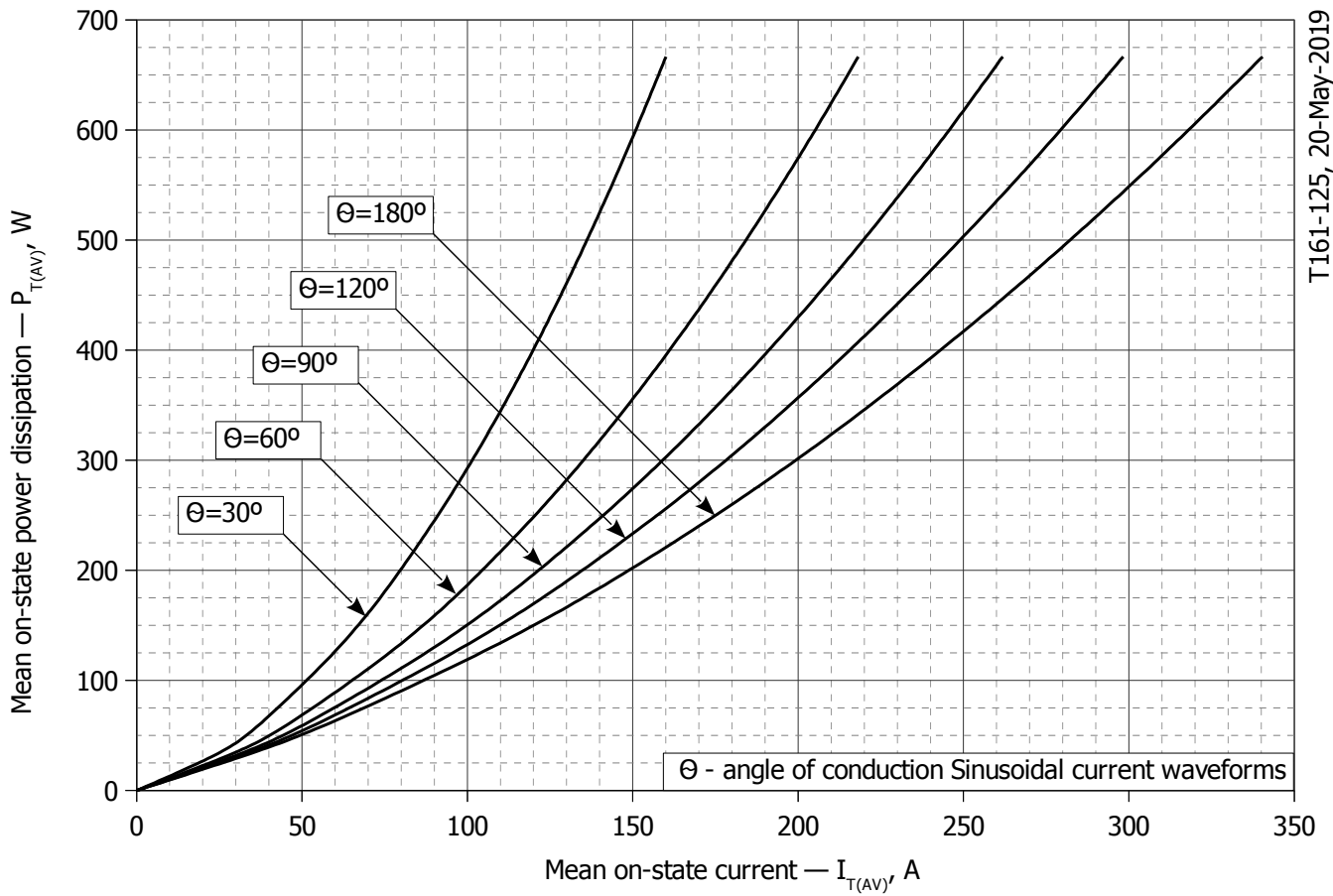
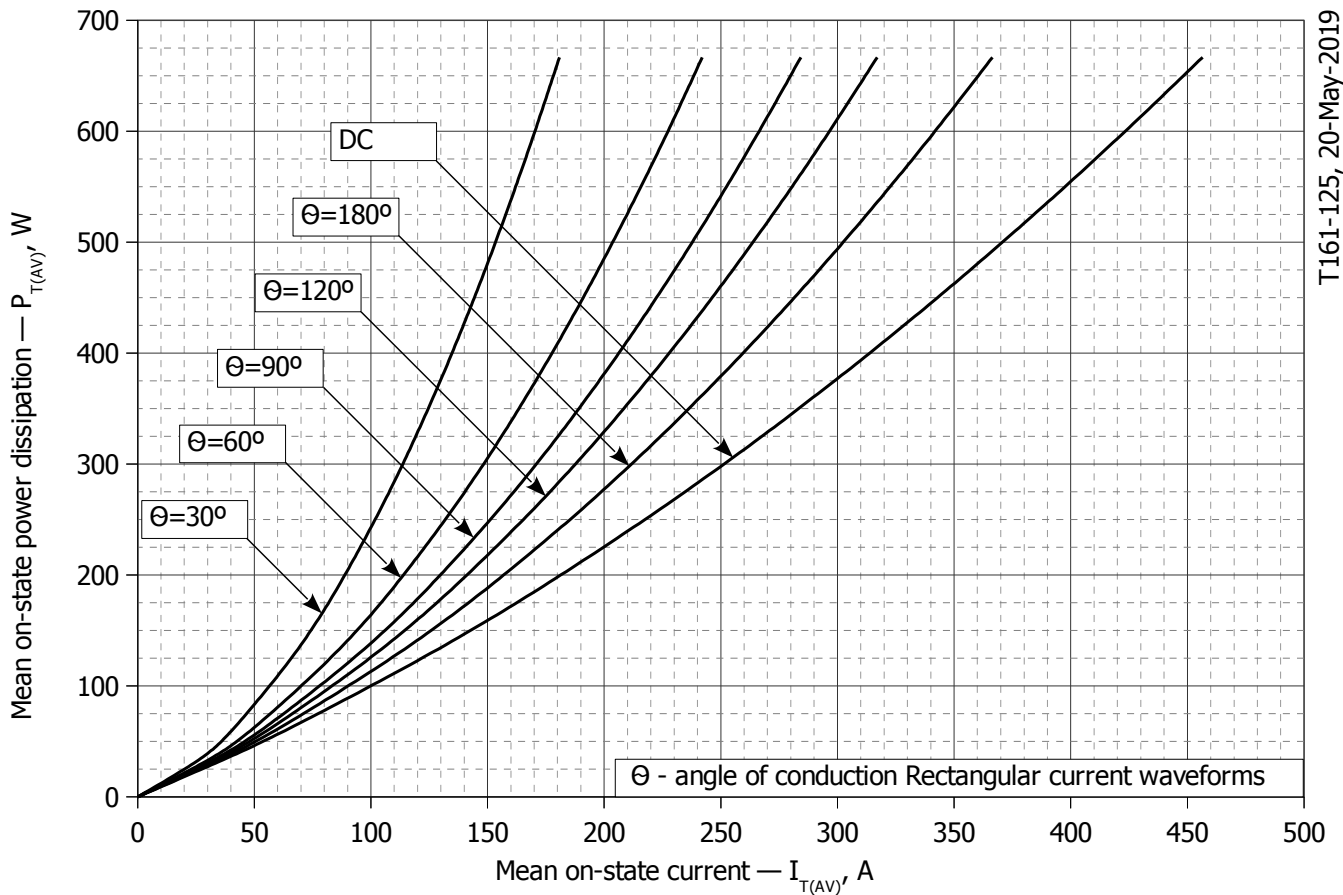

Fig 6 – Maximum recovery time t_{rr} vs. commutation rate di_R/dt (25% chord)



T161-125, 20-May-2019

Fig. 7 - Mean on-state power dissipation P_{TAV} vs. mean on-state current I_{TAV} for sinusoidal current waveforms at different conduction angles ($f=50\text{Hz}$, DSC)



T161-125, 20-May-2019

Fig. 8 - Mean on-state power dissipation P_{TAV} vs. mean on-state current I_{TAV} for rectangular current waveforms at different conduction angles and for DC ($f=50\text{Hz}$, DSC)

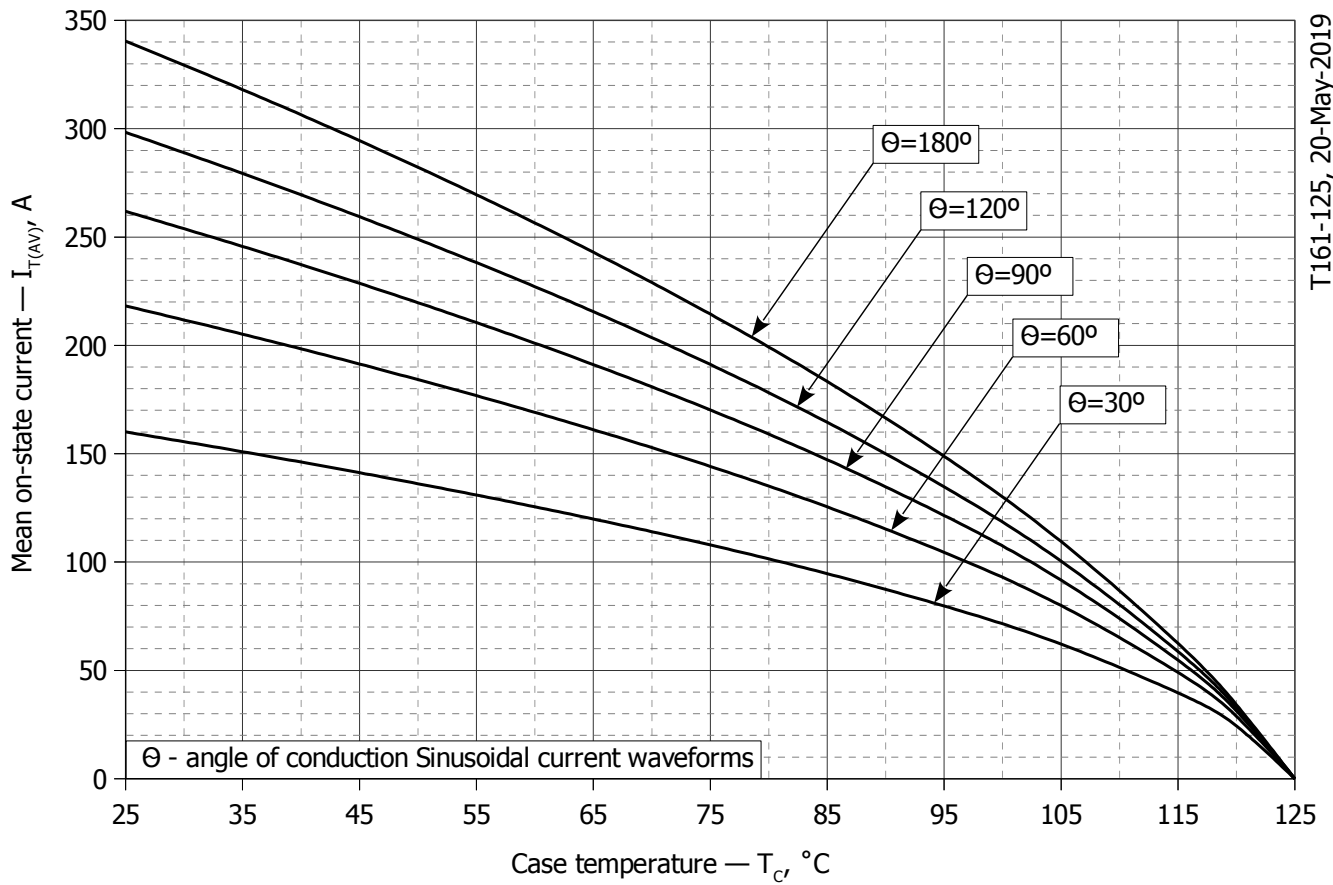

Fig. 9 – Mean on-state current I_{TAV} vs. case temperature T_C for sinusoidal current waveforms at different conduction angles ($f=50Hz$, DSC)

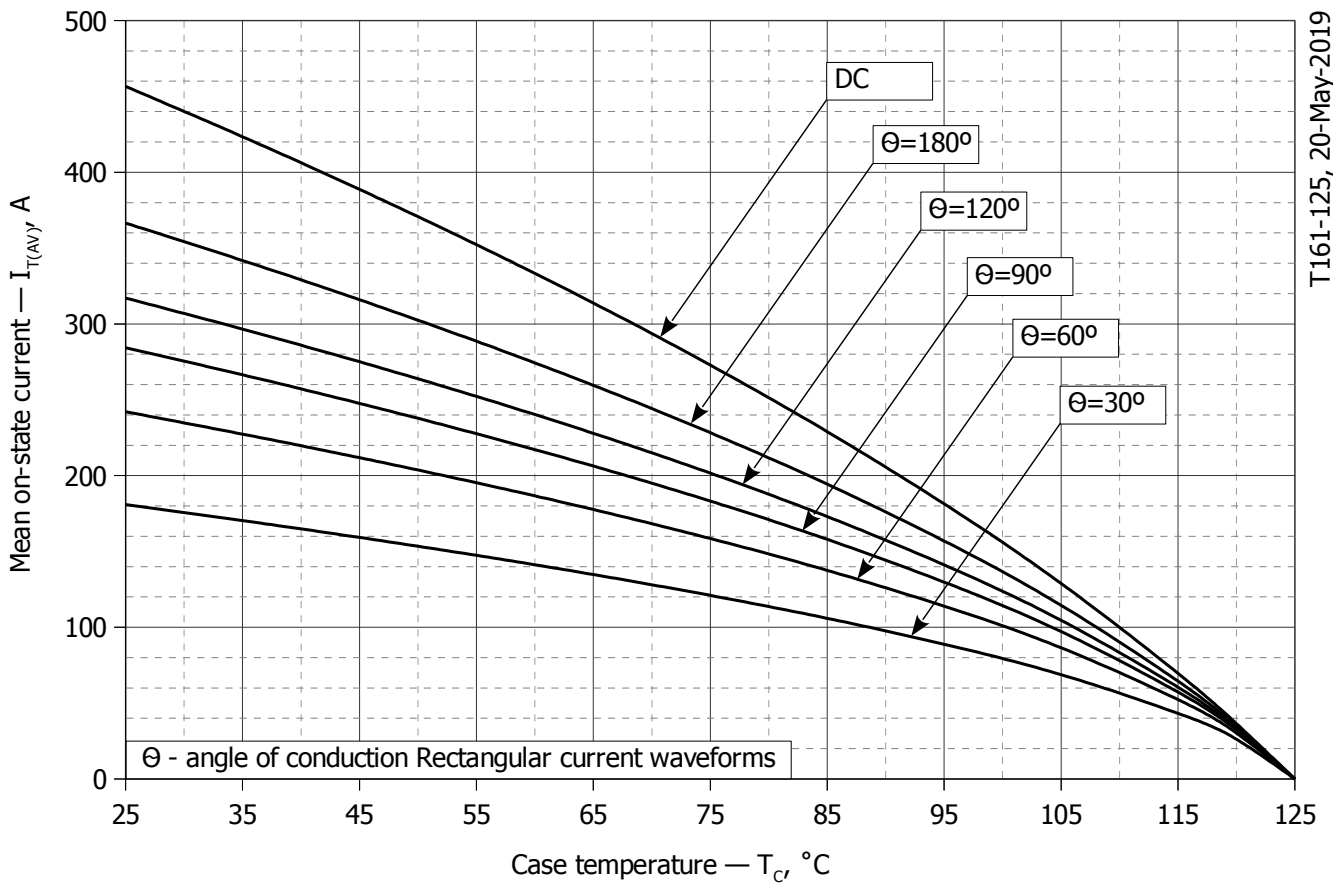

Fig. 10 - Mean on-state current I_{TAV} vs. case temperature T_C for rectangular current waveforms at different conduction angles and for DC ($f=50Hz$, DSC)

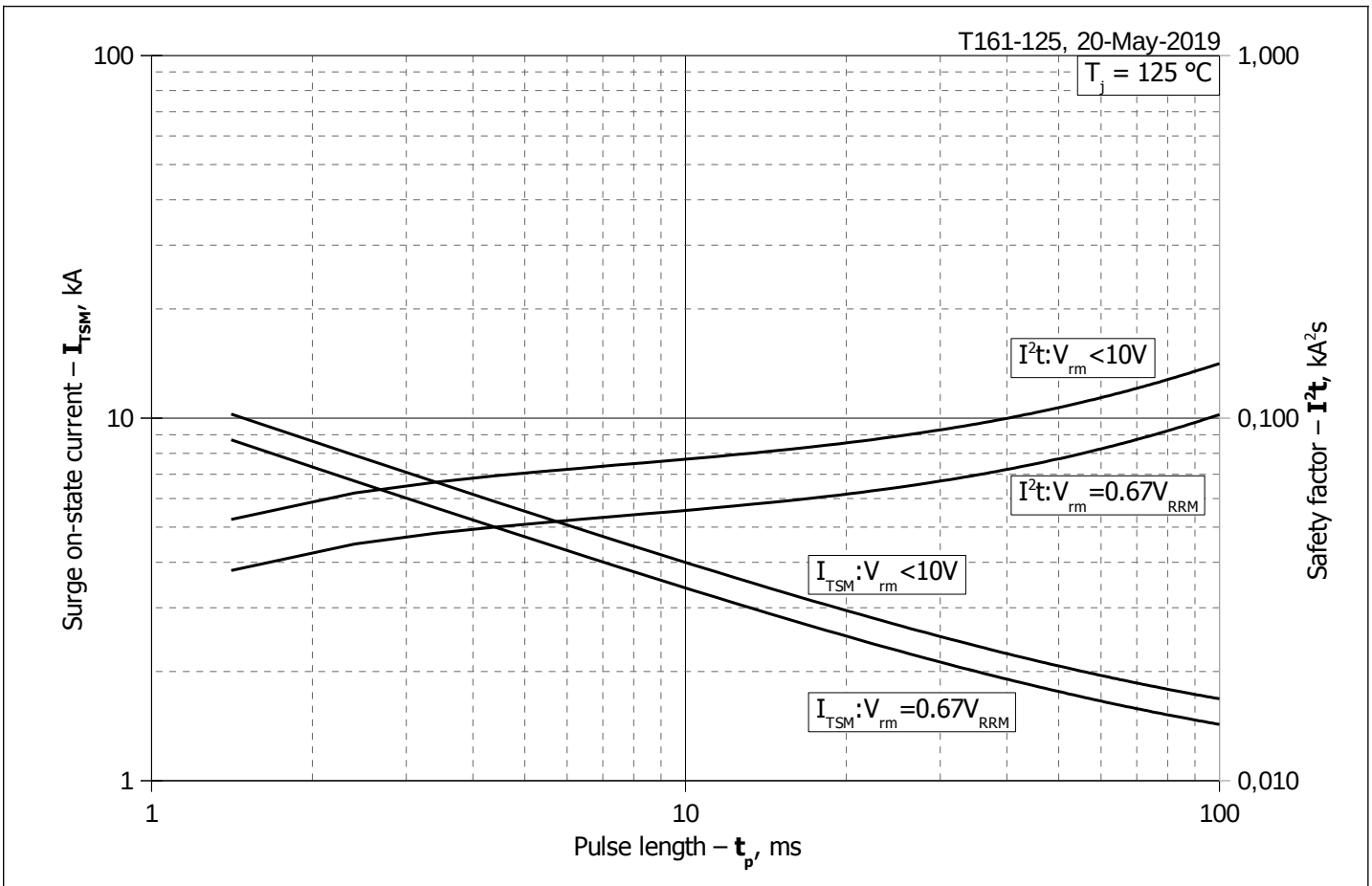

Fig. 11 – Maximum surge on-state current I_{TSM} and safety factor I^2t vs. pulse length t_p

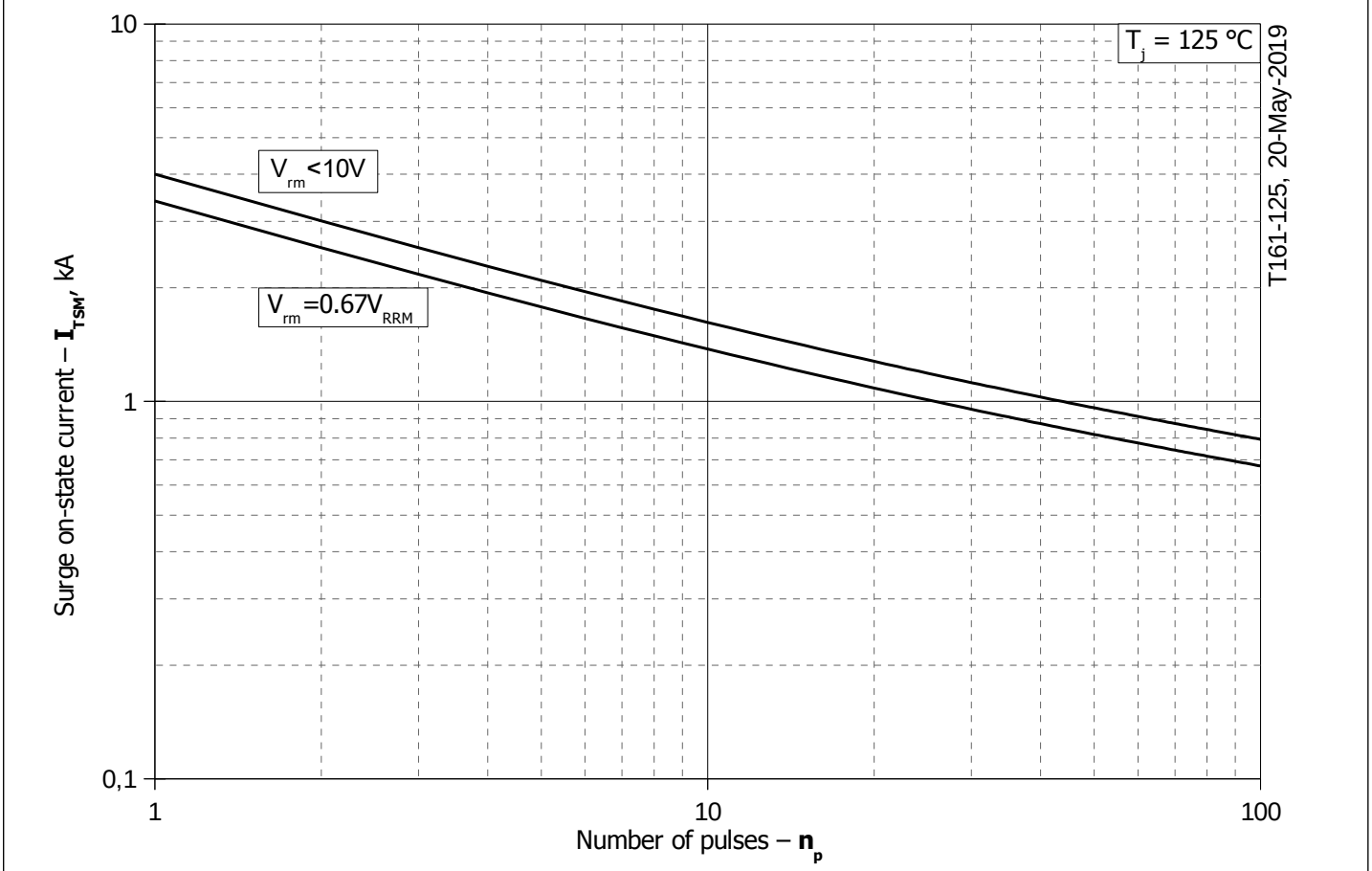

Fig. 12 - Maximum surge on-state current I_{TSM} vs. number of pulses n_p