



High power cycling capability
Low on-state and switching losses
Designed for traction and industrial applications

Phase Control Thyristor Type T193-3600-36

Mean on-state current	I_{TAV}	3600 A		
Repetitive peak off-state voltage	V_{DRM}	3000 ÷ 3600 V		
Repetitive peak reverse voltage	V_{RRM}			
Turn-off time	t_q	630 μ s		
V_{DRM}, V_{RRM}, V	3000	3200	3400	3600
Voltage code	30	32	34	36
$T_j, ^\circ C$	- 60 ÷ 125			

MAXIMUM ALLOWABLE RATINGS

Symbols and parameters		Units	Values	Test conditions
ON-STATE				
I_{TAV}	Mean on-state current	A	3600 4930	$T_c = 91^\circ C$, Double side cooled $T_c = 70^\circ C$, Double side cooled 180° half-sine wave; 50 Hz
I_{TRMS}	RMS on-state current	A	5652	$T_c = 91^\circ C$, Double side cooled 180° half-sine wave; 50 Hz
I_{TSM}	Surge on-state current	kA	72.0 83.0	180° half-sine wave; 50 Hz ($t_p = 10$ ms); single pulse; $V_D = V_R = 0$ V; Gate pulse: $I_G = 2$ A; $t_{GP} = 50$ μ s; $di_G/dt \geq 1$ A/ μ s $T_j = T_{jmax}$ $T_j = 25^\circ C$
			76.0 87.0	180° half-sine wave; 60 Hz ($t_p = 8.3$ ms); single pulse; $V_D = V_R = 0$ V; Gate pulse: $I_G = 2$ A; $t_{GP} = 50$ μ s; $di_G/dt \geq 1$ A/ μ s $T_j = T_{jmax}$ $T_j = 25^\circ C$
I^2t	Safety factor	$A^2s \cdot 10^3$	25920 34445	180° half-sine wave; 50 Hz ($t_p = 10$ ms); single pulse; $V_D = V_R = 0$ V; Gate pulse: $I_G = 2$ A; $t_{GP} = 50$ μ s; $di_G/dt \geq 1$ A/ μ s $T_j = T_{jmax}$ $T_j = 25^\circ C$
			23970 31410	180° half-sine wave; 60 Hz ($t_p = 8.3$ ms); single pulse; $V_D = V_R = 0$ V; Gate pulse: $I_G = 2$ A; $t_{GP} = 50$ μ s; $di_G/dt \geq 1$ A/ μ s $T_j = T_{jmax}$ $T_j = 25^\circ C$
BLOCKING				
V_{DRM}, V_{RRM}	Repetitive peak off-state and Repetitive peak reverse voltages	V	3000 ÷ 3600	$T_{jmin} < T_j < T_{jmax}$; 180° half-sine wave; 50 Hz; Gate open
V_{DSM}, V_{RSM}	Non-repetitive peak off-state and Non-repetitive peak reverse voltages	V	3100 ÷ 3700	$T_{jmin} < T_j < T_{jmax}$; 180° half-sine wave; 50 Hz; single pulse; Gate open
V_D, V_R	Direct off-state and Direct reverse voltages	V	$0.75 \cdot V_{DRM}$ $0.75 \cdot V_{RRM}$	$T_j = T_{jmax}$; Gate open

TRIGGERING				
I_{FGM}	Peak forward gate current	A	12	$T_j = T_{j \max}$
V_{RGM}	Peak reverse gate voltage	V	5	
P_G	Gate power dissipation	W	5	$T_j = T_{j \max}$ for DC gate current
SWITCHING				
$(di_T/dt)_{crit}$	Critical rate of rise of on-state current non-repetitive (f=1 Hz)	A/ μ s	1000	$T_j = T_{j \max}$; $V_D = 0.67 \cdot V_{DRM}$; $I_{TM} = 2 I_{TAV}$; Gate pulse: $I_G = 2$ A; $t_{GP} = 50 \mu$ s; $di_G/dt \geq 1$ A/ μ s
THERMAL				
T_{stg}	Storage temperature	$^{\circ}$ C	-60 ÷ 125	
T_j	Operating junction temperature	$^{\circ}$ C	-60 ÷ 125	
MECHANICAL				
F	Mounting force	kN	70.0 ÷ 90.0	
a	Acceleration	m/s ²	50 100	Device unclamped Device clamped

CHARACTERISTICS

Symbols and parameters		Units	Values	Conditions	
ON-STATE					
V_{TM}	Peak on-state voltage, max	V	1.70	$T_j = 25 \text{ }^{\circ}$ C; $I_{TM} = 6300$ A	
$V_{T(TO)}$	On-state threshold voltage, max	V	0.90	$T_j = T_{j \max}$;	
r_T	On-state slope resistance, max	m Ω	0.110	$0.5 \pi I_{TAV} < I_T < 1.5 \pi I_{TAV}$	
I_L	Latching current, max	mA	1500	$T_j = 25 \text{ }^{\circ}$ C; $V_D = 12$ V; Gate pulse: $I_G = 2$ A; $t_{GP} = 50 \mu$ s; $di_G/dt \geq 1$ A/ μ s	
I_H	Holding current, max	mA	300	$T_j = 25 \text{ }^{\circ}$ C; $V_D = 12$ V; Gate open	
BLOCKING					
I_{DRM} , I_{RRM}	Repetitive peak off-state and Repetitive peak reverse currents, max	mA	300	$T_j = T_{j \max}$; $V_D = V_{DRM}$; $V_R = V_{RRM}$	
$(dv_D/dt)_{crit}$	Critical rate of rise of off-state voltage ¹⁾ , min	V/ μ s	1000	$T_j = T_{j \max}$; $V_D = 0.67 \cdot V_{DRM}$; Gate open	
TRIGGERING					
V_{GT}	Gate trigger direct voltage, max	V	5.00	$T_j = T_{j \min}$ $T_j = 25 \text{ }^{\circ}$ C $T_j = T_{j \max}$	Direct gate current
			3.00		
			2.00		
I_{GT}	Gate trigger direct current, max	mA	500	$T_j = T_{j \min}$ $T_j = 25 \text{ }^{\circ}$ C $T_j = T_{j \max}$	
			300		
			200		
V_{GD}	Gate non-trigger direct voltage, min	V	0.35	$T_j = T_{j \max}$; $V_D = 0.67 \cdot V_{DRM}$;	
I_{GD}	Gate non-trigger direct current, min	mA	15.00	Direct gate current	
SWITCHING					
t_{gd}	Delay time	μ s	3.00	$T_j = 25 \text{ }^{\circ}$ C; $V_D = 0.4 \cdot V_{DRM}$; $I_{TM} = 2000$ A; Gate pulse: $I_G = 2$ A; $t_{GP} = 50 \mu$ s; $di_G/dt \geq 1$ A/ μ s	
t_q	Turn-off time ²⁾ , max	μ s	630	$dv_D/dt = 50$ V/ μ s; $T_j = T_{j \max}$; $I_{TM} = 2000$ A; $di_R/dt = -10$ A/ μ s; $V_R = 100$ V; $V_D = 0.67 V_{DRM}$;	
Q_{rr}	Total recovered charge, max	μ C	7000	$T_j = T_{j \max}$; $I_{TM} = 2000$ A;	
t_{rr}	Reverse recovery time, typ	μ s	68	$di_R/dt = -5$ A/ μ s;	
I_{rrM}	Peak reverse recovery current, max	A	205	$V_R = 100$ V	

THERMAL					
R_{thjc}	Thermal resistance, junction to case, max	°C/W	0.0050	Direct current	Double side cooled
R_{thjc-A}			0.0110		Anode side cooled
R_{thjc-K}			0.0090		Cathode side cooled
R_{thck}	Thermal resistance, case to heatsink, max	°C/W	0.0010	Direct current	
MECHANICAL					
w	Weight, typ	g	2200		
D_s	Surface creepage distance	mm (inch)	44.60 (1.756)		
D_a	Air strike distance	mm (inch)	15.70 (0.618)		

PART NUMBERING GUIDE

T	193	3600	36	N
1	2	3	4	5

1. Phase Control Thyristor
2. Design version
3. Mean on-state current, A
4. Voltage code
5. Ambient conditions: N – normal; T – tropical

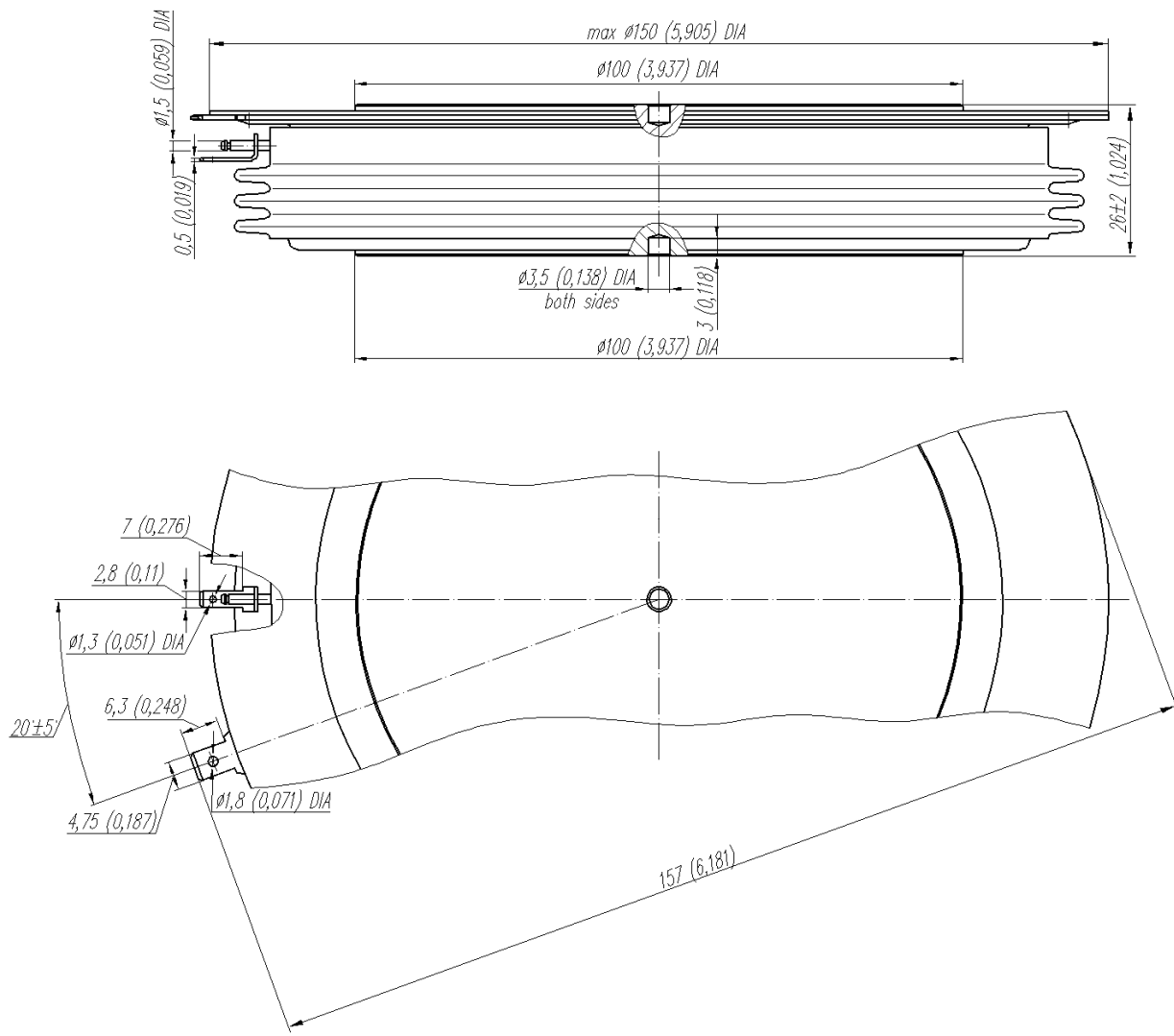

All dimensions in millimeters (inches)

The information contained herein is confidential and protected by Copyright.
 In the interest of product improvement, Proton-Electrotex reserves the right to change data sheet without notice.

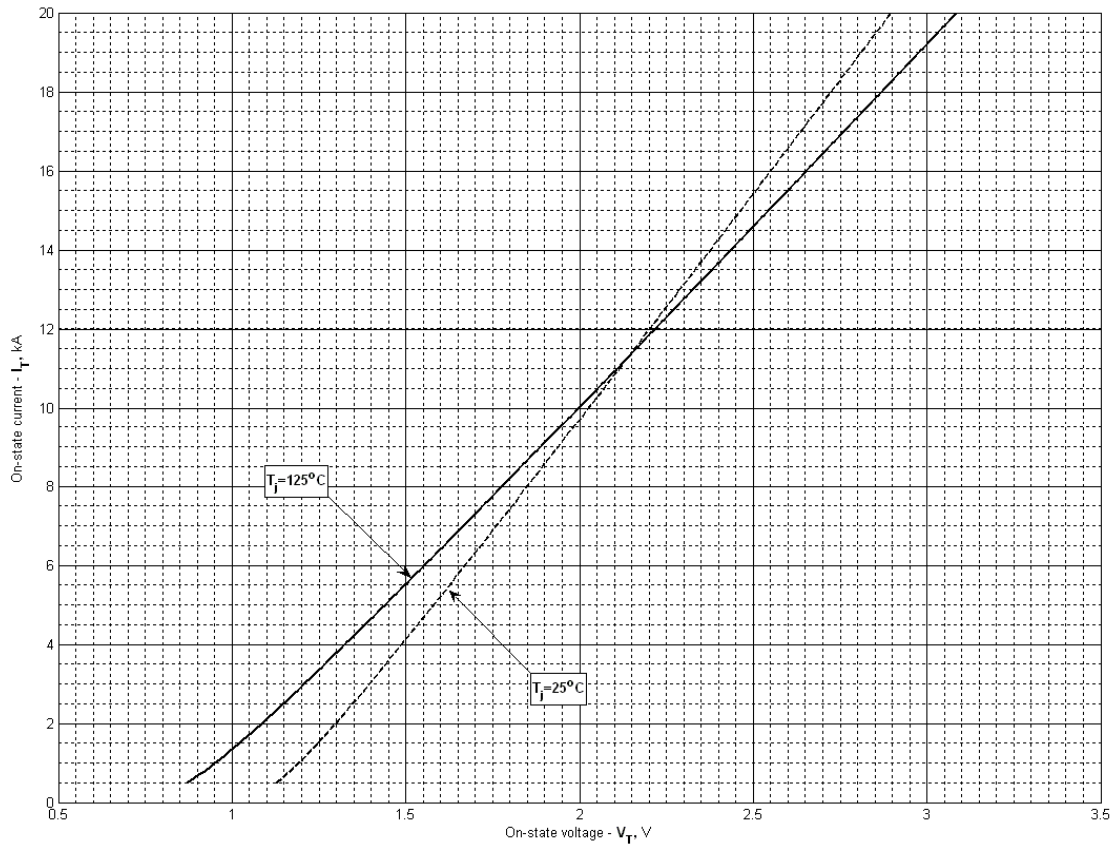

T193-3600, 25-Oct-2013

Fig 1 – On-state characteristics of Limit device

Analytical function for On-state characteristic:

$$V_T = A + B \cdot i_T + C \cdot \ln(i_T + 1) + D \cdot \sqrt{i_T}$$

	Coefficients for max curves	
	$T_j = 25^\circ\text{C}$	$T_j = T_{j \max}$
A	0.852713	1.112428
B	0.116208	0.092643
C	0.193655	0.144998
D	-0.152139	-0.113913

On-state characteristic model (see Fig. 1)

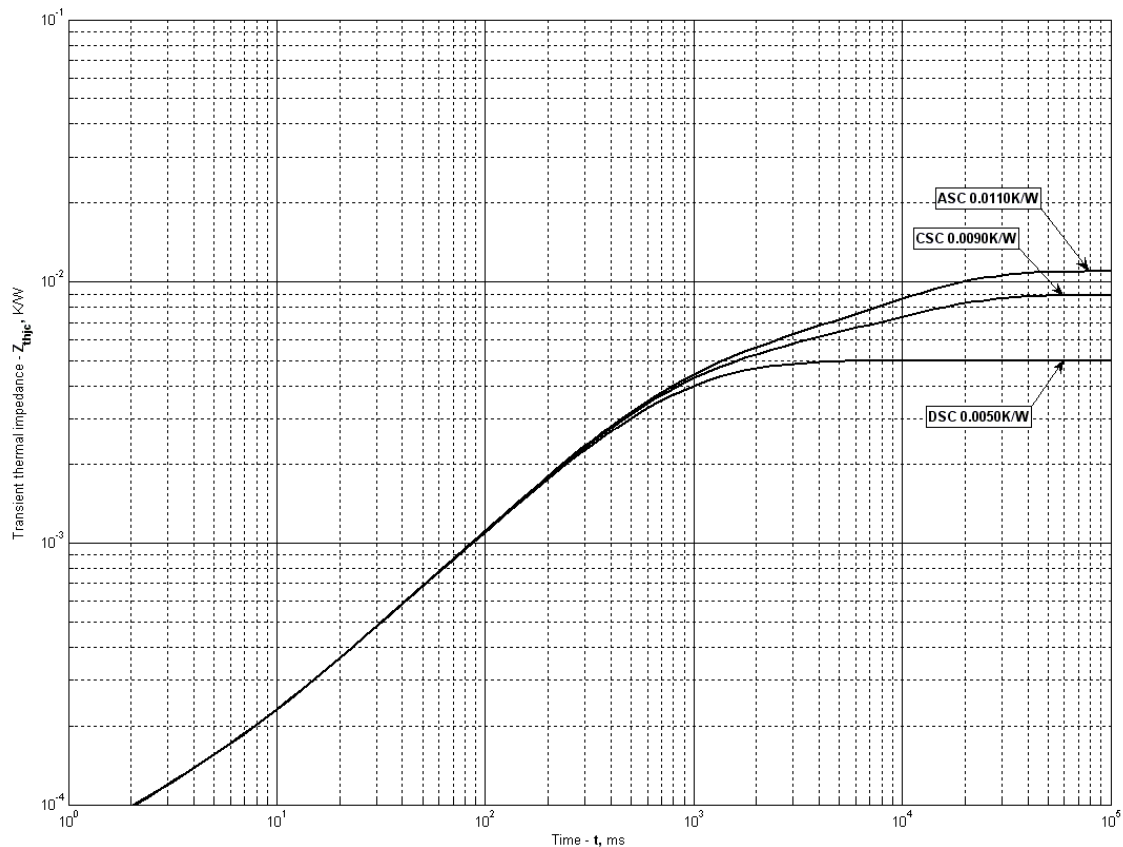

Fig 2 – Transient thermal impedance

Analytical function for Transient thermal impedance junction to case Z_{thjc} for DC:

$$Z_{thjc} = \sum_{i=1}^n R_i \left(1 - e^{-\frac{t}{\tau_i}} \right)$$

Where $i = 1$ to n , n is the number of terms in the series.

t = Duration of heating pulse in seconds.

Z_{thjc} = Thermal resistance at time t .

R_i = Amplitude of p_{th} term.

τ_i = Time constant of r_{th} term.

DC Double side cooled

i	1	2	3	4	5	6
$R_i, K/W$	0.002027	0.0001166	0.002627	0.0001539	3.237e-005	4.335e-005
τ_i, s	1.059	0.080	0.3836	0.02289	0.0003559	0.001397

DC Cathode side cooled

i	1	2	3	4	5	6
$R_i, K/W$	0.003885	0.002188	0.002508	0.0002154	3.854e-005	4.646e-005
τ_i, s	10.6	1.090	0.3745	0.03207	0.002565	0.0004383

DC Anode side cooled

i	1	2	3	4	5	6
$R_i, K/W$	0.005945	0.002218	0.00248	0.0002153	3.862e-005	4.604e-005
τ_i, s	10.6	1.120	0.3786	0.03196	0.002513	0.0004352

Transient thermal impedance junction to case Z_{thjc} model (see Fig. 2)

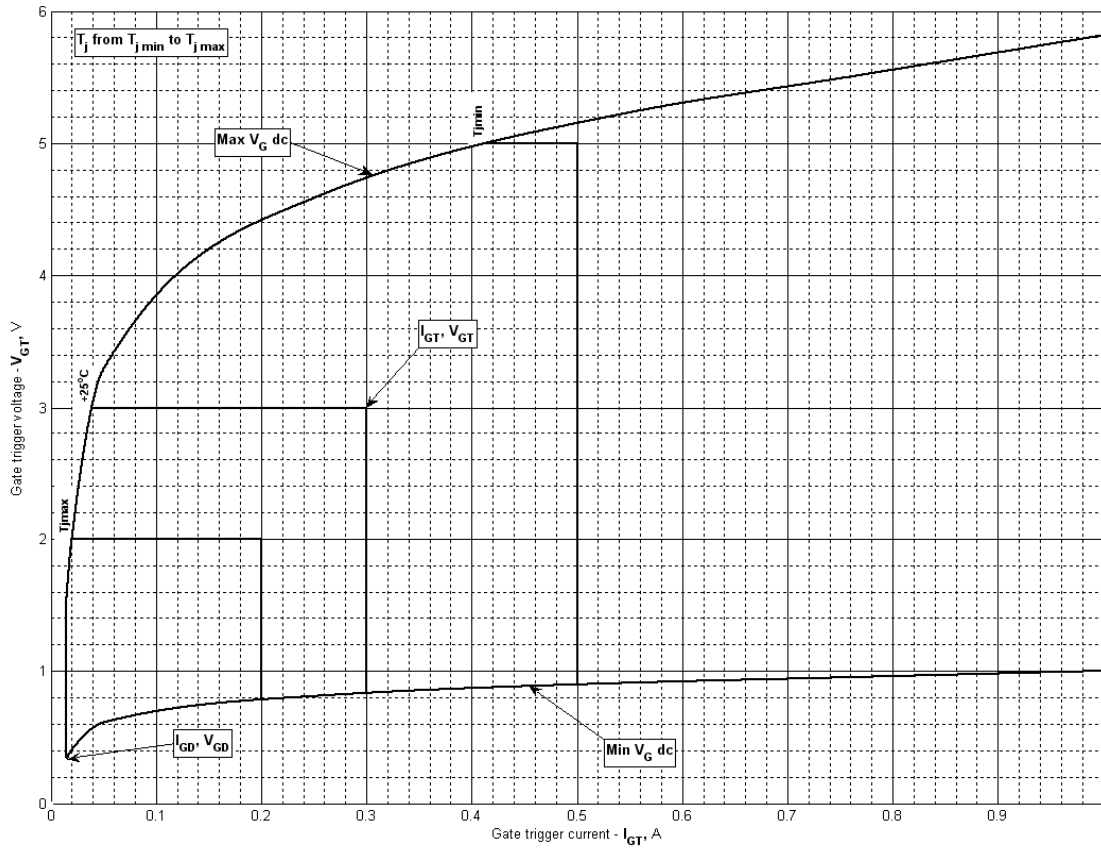

Fig 3 – Gate characteristics – Trigger limits

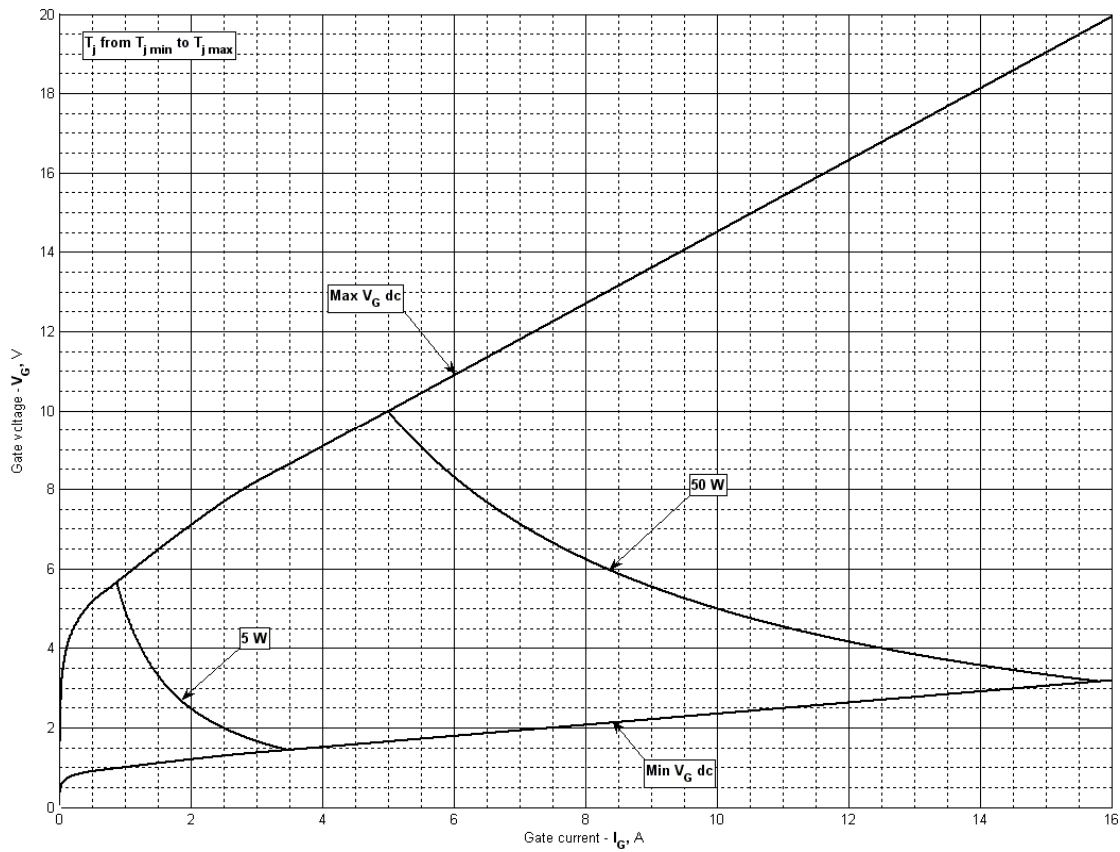

Fig 4 - Gate characteristics –Power curves

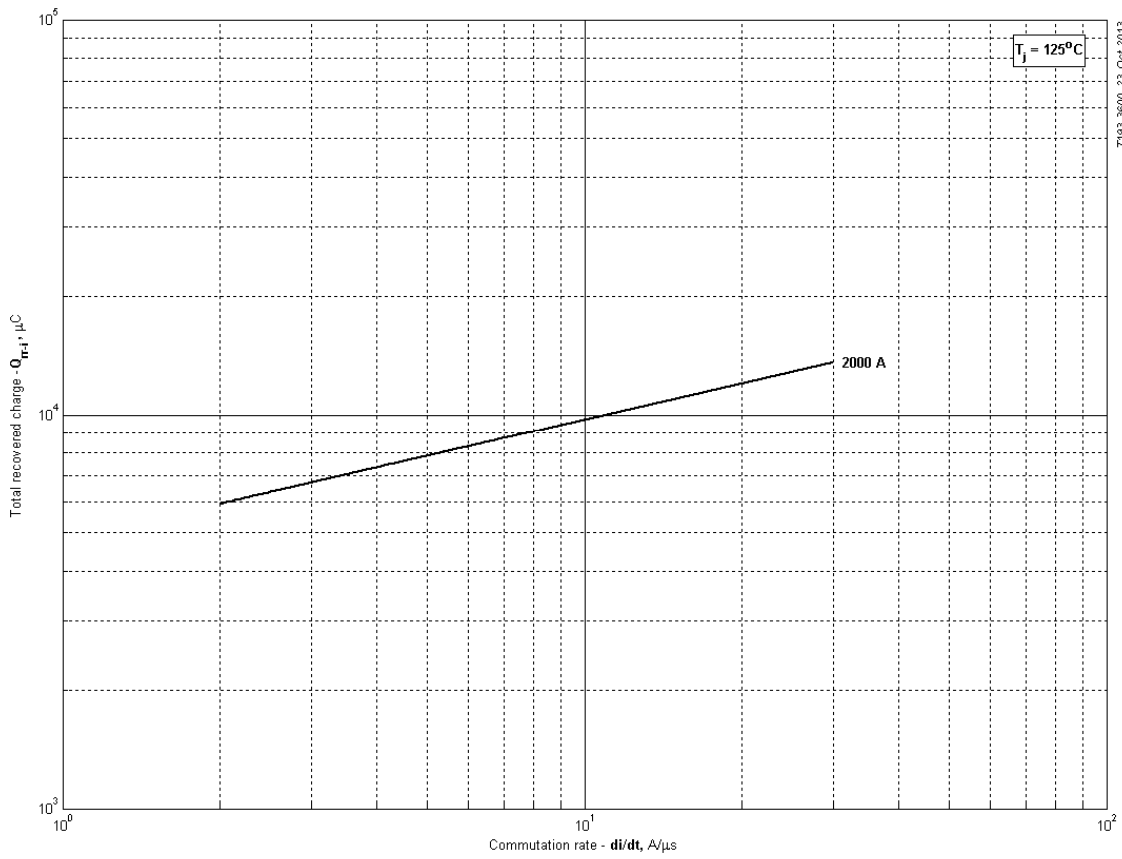

Fig 5 – Total recovered charge, Q_{rr-i} (integral)

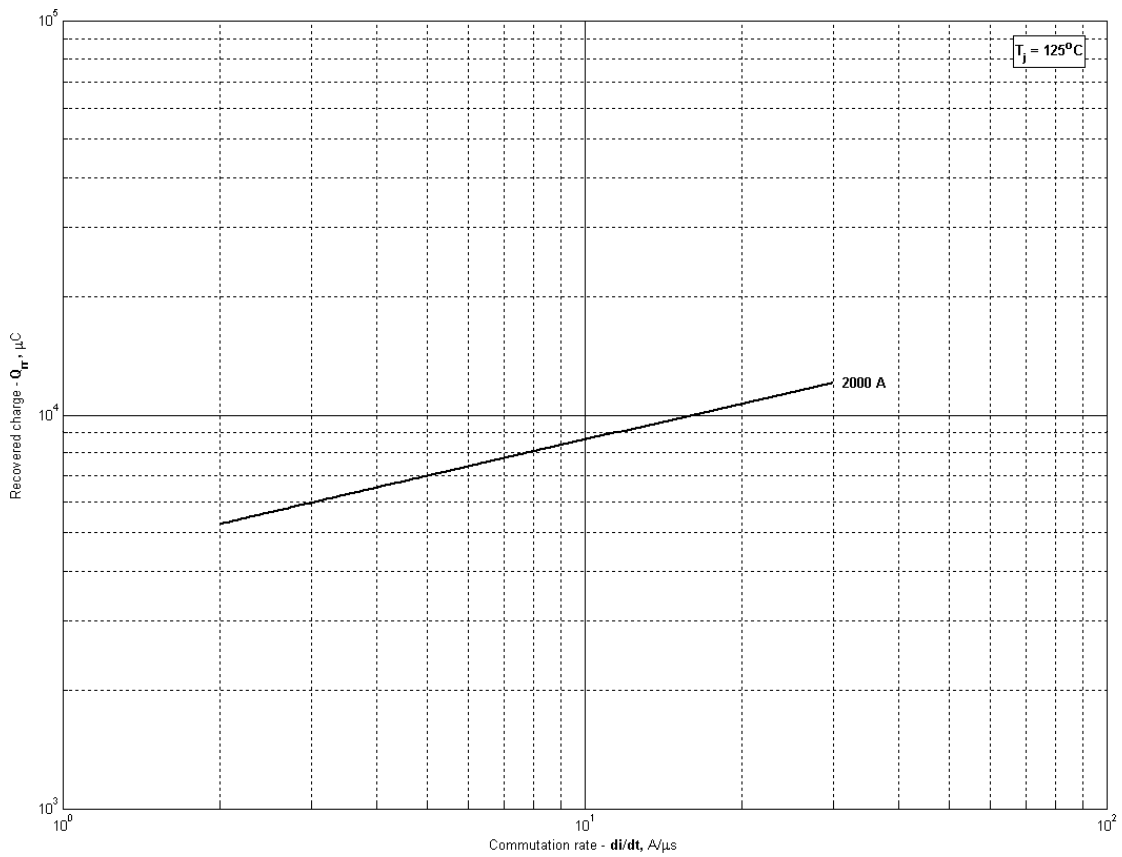

Fig 6 - Recovered charge, Q_{rr} (linear)

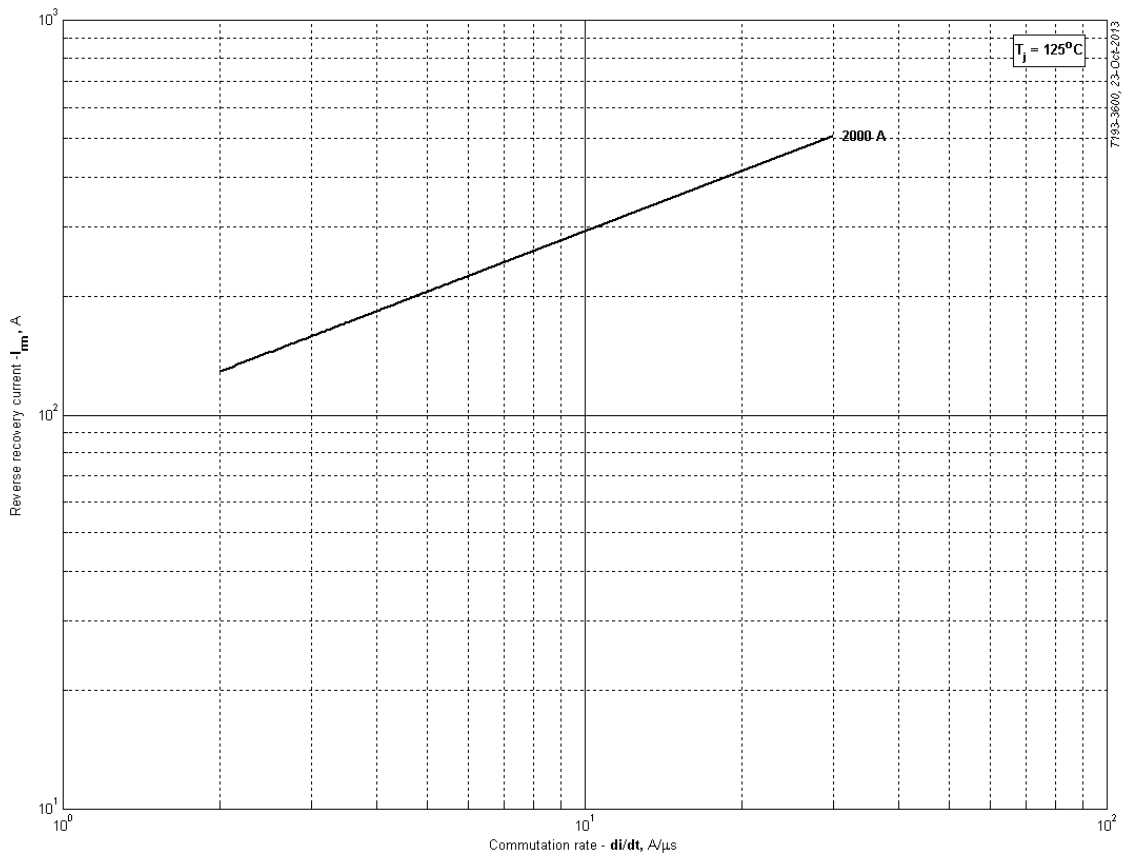

Fig 7 – Peak reverse recovery current, I_{rm}

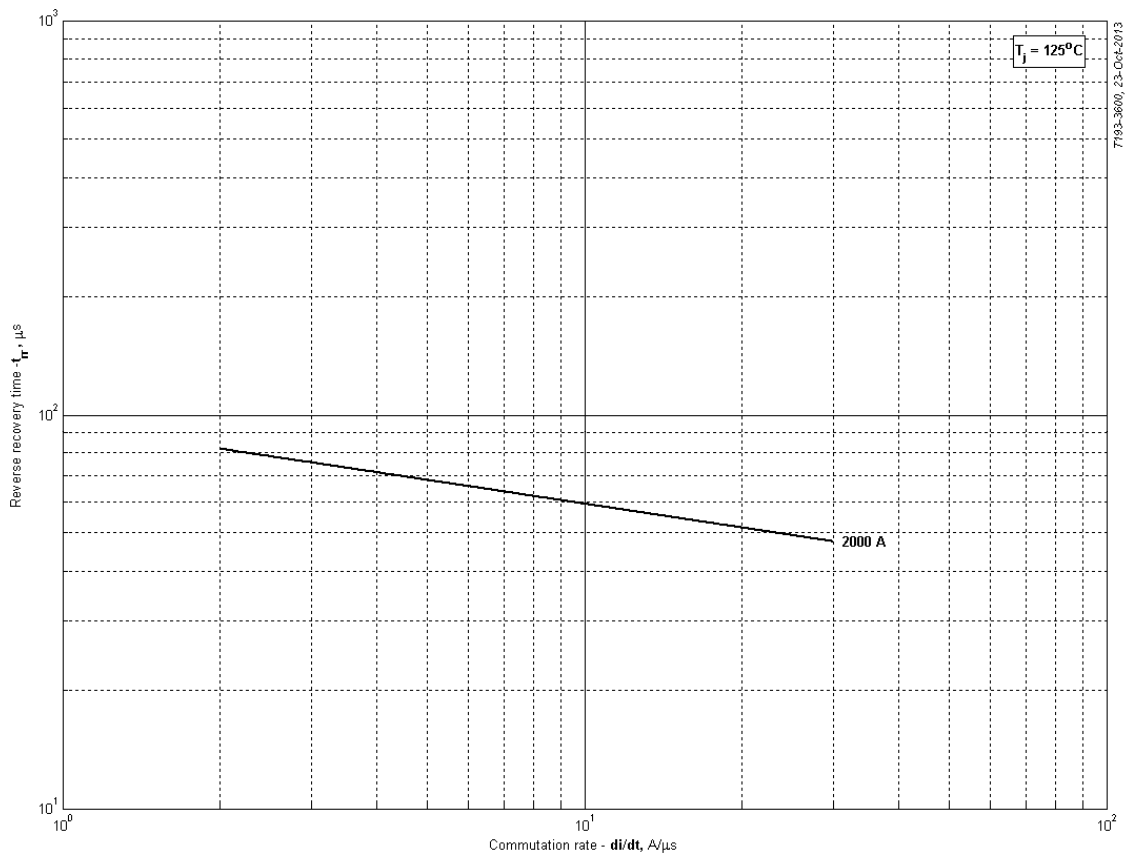

Fig 8 – Maximum recovery time, t_{rr} (linear)

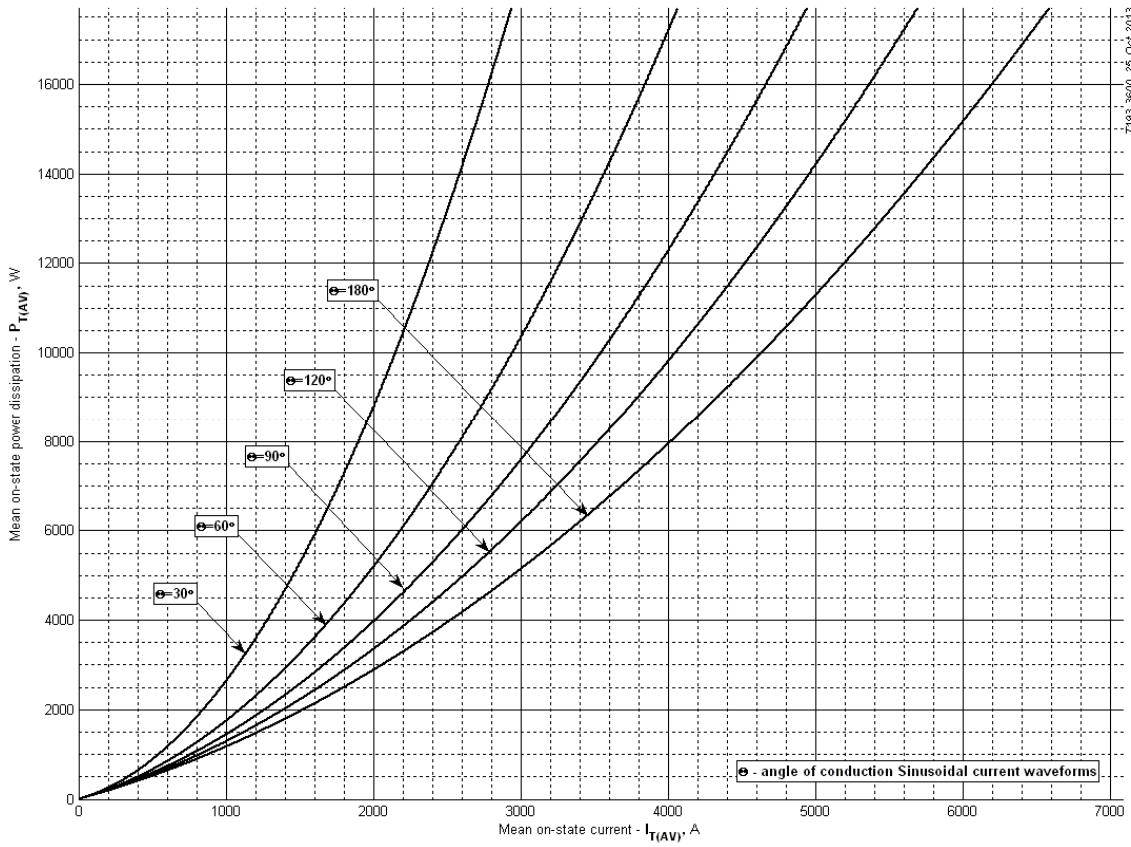

Fig 9 – On-state power loss (sinusoidal current waveforms)

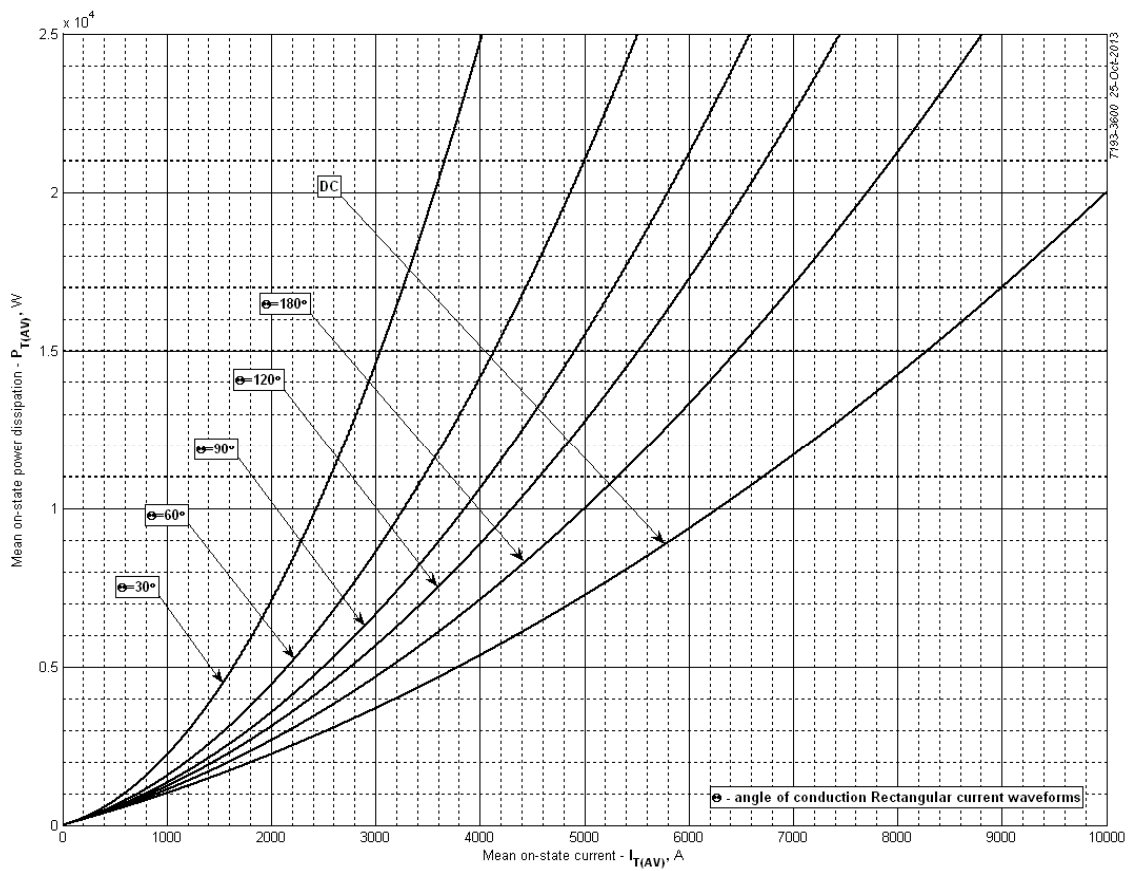

Fig 10 – On-state power loss (rectangular current waveforms)

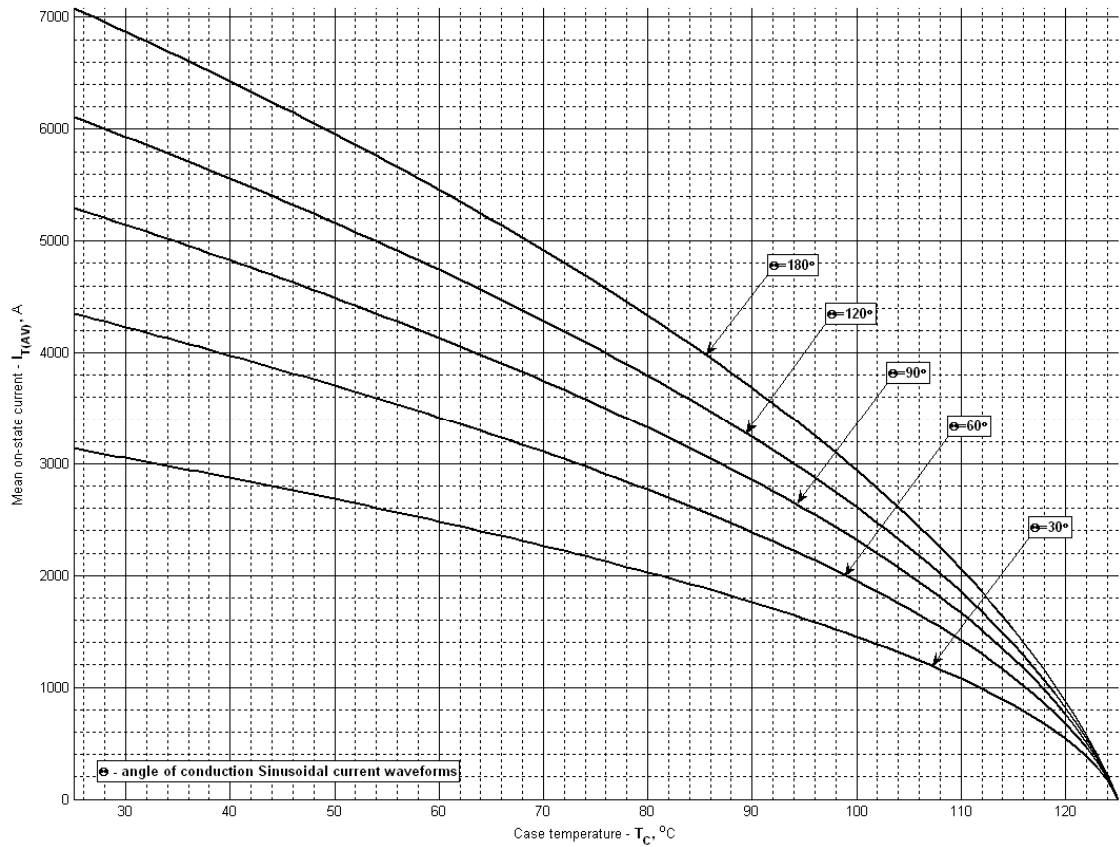

Fig 11 – Maximum case temperature DSC (sinusoidal current waveforms)

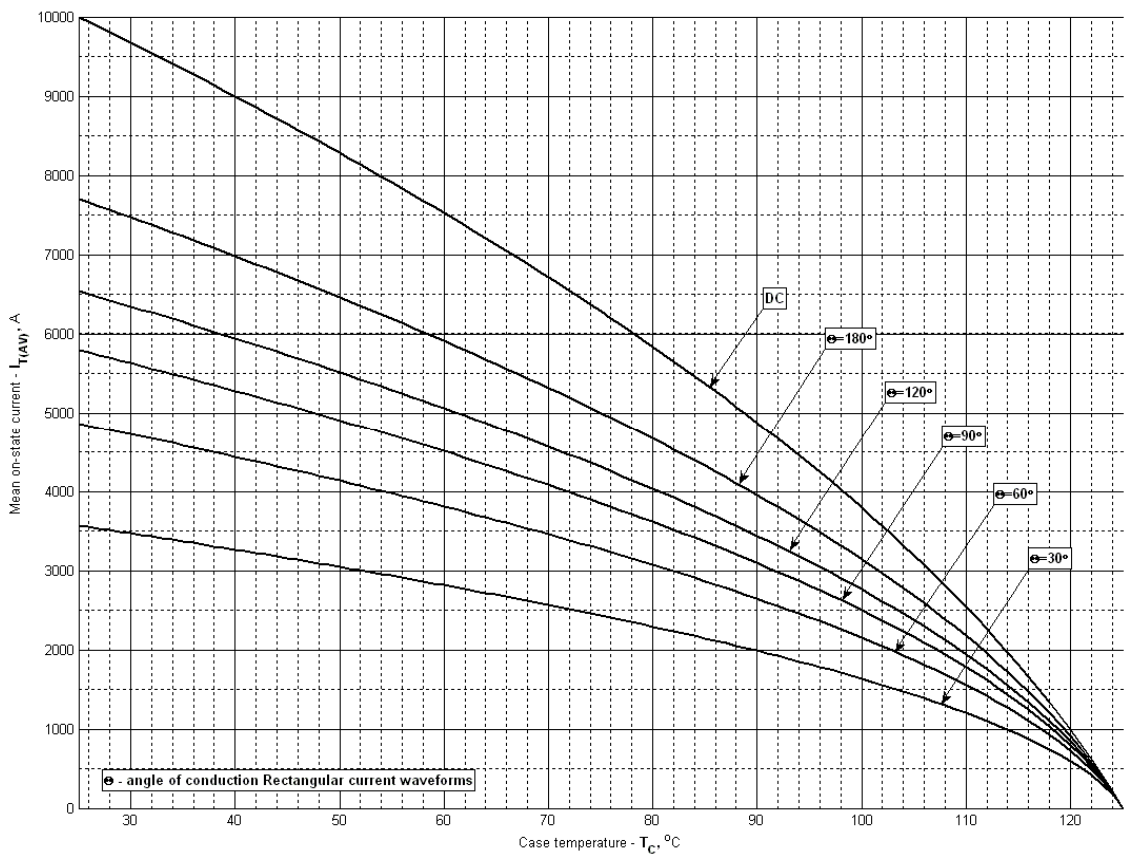

Fig 12 – Maximum case temperature DSC (rectangular current waveforms)

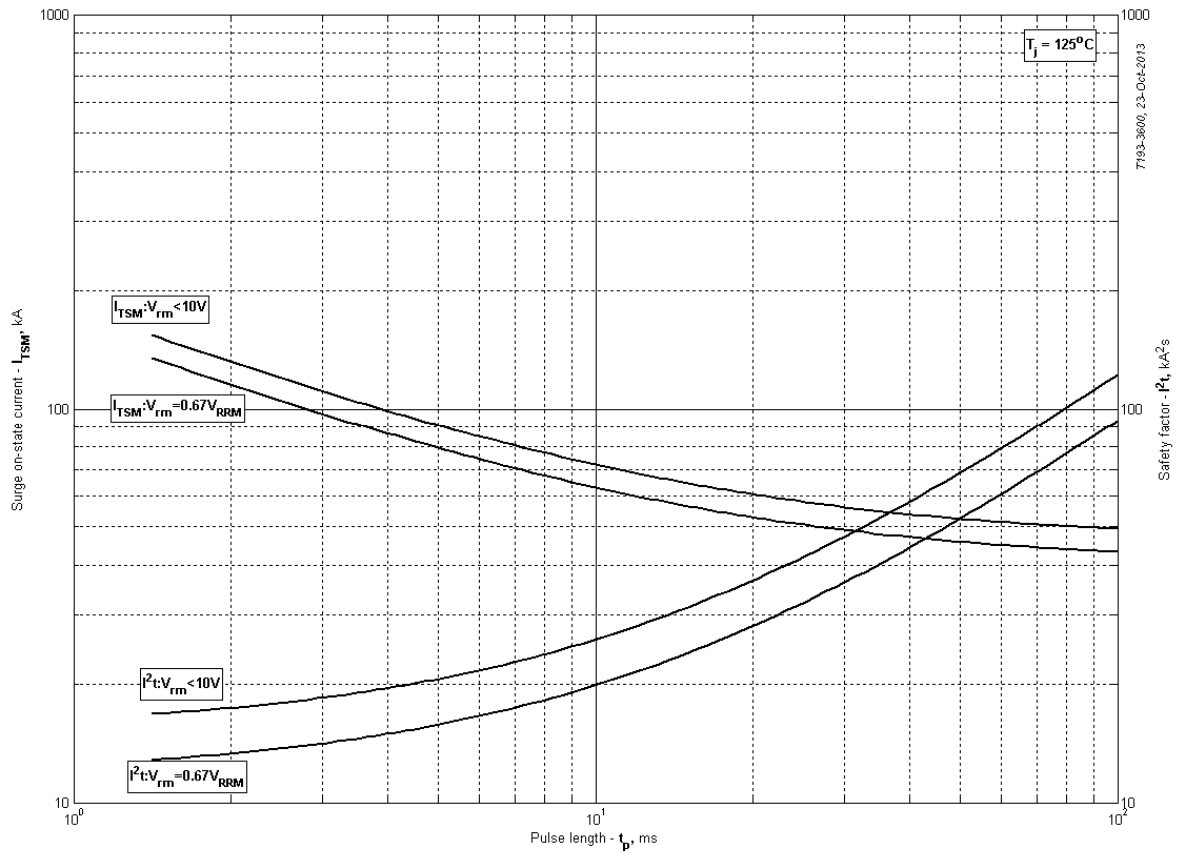

Fig 13 – Maximum surge and I^2t ratings

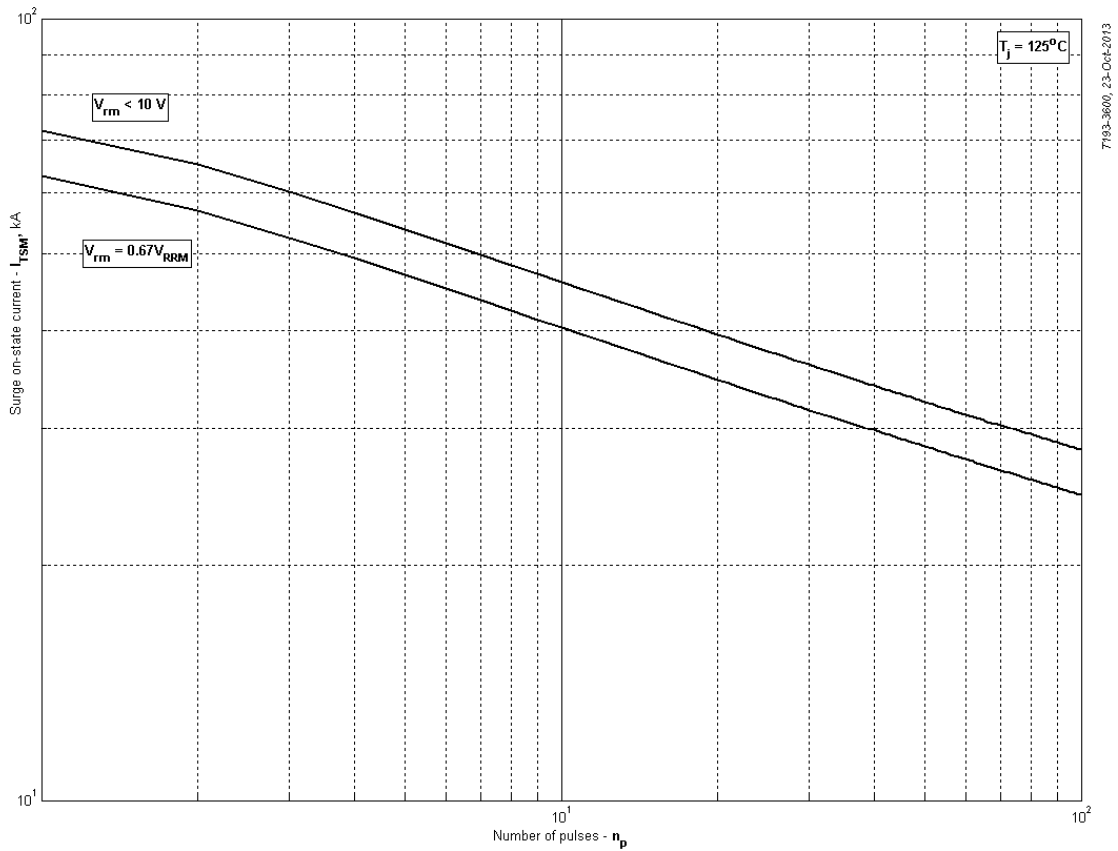

Fig 14 – Maximum surge ratings