



**Fast Thyristor
Type TFI143-500-15**

Low switching losses
Low reverse recovery charge
Distributed amplified gate for high di_T/dt

Mean on-state current	I_{TAV}			500 A		
Repetitive peak off-state voltage	V_{DRM}			1000 ÷ 1500 V		
Repetitive peak reverse voltage	V_{RRM}					
Turn-off time	t_q			12.5, 16.0, 20.0, 25.0 μs		
V_{DRM}, V_{RRM}, V	1000	1100	1200	1300	1400	1500
Voltage code	10	11	12	13	14	15
$T_j, ^\circ C$	- 60 ÷ 125					

MAXIMUM ALLOWABLE RATINGS

Symbols and parameters		Units	Values	Test conditions	
ON-STATE					
I_{TAV}	Mean on-state current	A	500 756	$T_c = 85^\circ C$; Double side cooled; $T_c = 55^\circ C$; Double side cooled; 180° half-sine wave; 50 Hz	
I_{TRMS}	RMS on-state current	A	785	$T_c = 85^\circ C$; Double side cooled; 180° half-sine wave; 50 Hz	
I_{TSM}	Surge on-state current	kA	9.0 10.5	$T_j = T_{jmax}$ $T_j = 25^\circ C$	180° half-sine wave; $t_p = 10$ ms; single pulse; $V_D = V_R = 0$ V; Gate pulse: $I_G = I_{FGM}$; $V_G = 20$ V; $t_{GP} = 50$ μs ; $di_G/dt = 1$ A/ μs
			9.5 11.0	$T_j = T_{jmax}$ $T_j = 25^\circ C$	180° half-sine wave; $t_p = 8.3$ ms; single pulse; $V_D = V_R = 0$ V; Gate pulse: $I_G = I_{FGM}$; $V_G = 20$ V; $t_{GP} = 50$ μs ; $di_G/dt = 1$ A/ μs
I^2t	Safety factor	$A^2s \cdot 10^3$	400 550	$T_j = T_{jmax}$ $T_j = 25^\circ C$	180° half-sine wave; $t_p = 10$ ms; single pulse; $V_D = V_R = 0$ V; Gate pulse: $I_G = I_{FGM}$; $V_G = 20$ V; $t_{GP} = 50$ μs ; $di_G/dt = 1$ A/ μs
			370 500	$T_j = T_{jmax}$ $T_j = 25^\circ C$	180° half-sine wave; $t_p = 8.3$ ms; single pulse; $V_D = V_R = 0$ V; Gate pulse: $I_G = I_{FGM}$; $V_G = 20$ V; $t_{GP} = 50$ μs ; $di_G/dt = 1$ A/ μs
BLOCKING					
V_{DRM}, V_{RRM}	Repetitive peak off-state and Repetitive peak reverse voltages	V	1000 ÷ 1500	$T_{jmin} < T_j < T_{jmax}$; 180° half-sine wave; 50 Hz; Gate open	
V_{DSM}, V_{RSM}	Non-repetitive peak off-state and Non-repetitive peak reverse voltages	V	1100 ÷ 1600	$T_{jmin} < T_j < T_{jmax}$; 180° half-sine wave; single pulse; Gate open	
V_D, V_R	Direct off-state and Direct reverse voltages	V	0.6 V_{DRM} 0.6 V_{RRM}	$T_j = T_{jmax}$; Gate open	

TRIGGERING				
I_{FGM}	Peak forward gate current	A	8	$T_j = T_{j\ max}$
V_{RGM}	Peak reverse gate voltage	V	5	
P_G	Gate power dissipation	W	8	$T_j = T_{j\ max}$ for DC gate current
SWITCHING				
$(di_T/dt)_{crit}$	Critical rate of rise of on-state current non-repetitive (f=1 Hz)	A/ μ s	2000	$T_j = T_{j\ max}$; $V_D = 0.67 \cdot V_{DRM}$; $I_{TM} = 2 I_{TAV}$; Gate pulse: $I_G = I_{FGM}$; $V_G = 20$ V; $t_{GP} = 50$ μ s; $di_G/dt = 2$ A/ μ s
THERMAL				
T_{stg}	Storage temperature	$^{\circ}$ C	- 60 ÷ 50	
T_j	Operating junction temperature	$^{\circ}$ C	- 60 ÷ 125	
MECHANICAL				
F	Mounting force	kN	14.0 ÷ 16.0	
a	Acceleration	m/s ²	50	Device clamped

CHARACTERISTICS

Symbols and parameters		Units	Values	Conditions	
ON-STATE					
V_{TM}	Peak on-state voltage, max	V	2.40	$T_j = 25$ $^{\circ}$ C; $I_{TM} = 1570$ A	
$V_{T(TO)}$	On-state threshold voltage, max	V	1.40	$T_j = T_{j\ max}$;	
r_T	On-state slope resistance, max	m Ω	0.80	$0.5 \pi I_{TAV} < I_T < 1.5 \pi I_{TAV}$	
I_H	Holding current, max	mA	500	$T_j = 25$ $^{\circ}$ C; $V_D = 12$ V; Gate open	
BLOCKING					
I_{DRM}, I_{RRM}	Repetitive peak off-state and Repetitive peak reverse currents, max	mA	100	$T_j = T_{j\ max}$; $V_D = V_{DRM}$; $V_R = V_{RRM}$	
$(dv_D/dt)_{crit}$	Critical rate of rise of off-state voltage ¹⁾ , min	V/ μ s	200, 320, 500, 1000	$T_j = T_{j\ max}$; $V_D = 0.67 \cdot V_{DRM}$; Gate open	
TRIGGERING					
V_{GT}	Gate trigger direct voltage, max	V	4.00 2.50 2.00	$T_j = T_{j\ min}$ $T_j = 25$ $^{\circ}$ C $T_j = T_{j\ max}$	$V_D = 12$ V; $I_D = 3$ A; Direct gate current
I_{GT}	Gate trigger direct current, max	mA	500 300 200	$T_j = T_{j\ min}$ $T_j = 25$ $^{\circ}$ C $T_j = T_{j\ max}$	
V_{GD}	Gate non-trigger direct voltage, min	V	0.25	$T_j = T_{j\ max}$; $V_D = 0.67 \cdot V_{DRM}$;	
I_{GD}	Gate non-trigger direct current, min	mA	10.00	Direct gate current	
SWITCHING					
t_{gd}	Delay time, max	μ s	0.80	$T_j = 25$ $^{\circ}$ C; $V_D = 600$ V; $I_{TM} = I_{TAV}$; $di/dt = 200$ A/ μ s;	
t_{gt}	Turn-on time ²⁾	μ s	1.60, 2.00, 2.50, 3.20	Gate pulse: $I_G = I_{FGM}$; $V_G = 20$ V; $t_{GP} = 50$ μ s; $di_G/dt = 2$ A/ μ s	
t_q	Turn-off time ³⁾ max	μ s	12.5, 16.0, 20.0, 25.0	$dv_D/dt = 50$ V/ μ s;	$T_j = T_{j\ max}$; $I_{TM} = I_{TAV}$; $di_R/dt = -10$ A/ μ s; $V_R = 100$ V; $V_D = 0.67 \cdot V_{DRM}$
			16.0, 20.0, 25.0, 32.0	$dv_D/dt = 200$ V/ μ s;	
Q_{rr}	Total recovered charge, max	μ C	200	$T_j = T_{j\ max}$; $I_{TM} = 500$ A;	
t_{rr}	Reverse recovery time, typ	μ s	4.0	$di_R/dt = -50$ A/ μ s;	
I_{rrM}	Peak reverse recovery current, max	A	115	$V_R = 100$ V	

THERMAL					
R_{thjc}	Thermal resistance, junction to case, max	°C/W	0.0320	Direct current	Double side cooled
R_{thjc-A}			0.0704		Anode side cooled
R_{thjc-K}			0.0576		Cathode side cooled
R_{thck}	Thermal resistance, case to heatsink, max	°C/W	0.0060	Direct current	
MECHANICAL					
w	Weight, max	g	280		
D_s	Surface creepage distance	mm (inch)	27.60 (1.087)		
D_a	Air strike distance	mm (inch)	16.00 (0.630)		

PART NUMBERING GUIDE								NOTES																																		
TFI	143	500	15	A2	X3	T4	N	¹⁾ Critical rate of rise of off-state voltage <table border="1"> <thead> <tr> <th>Symbol of group</th> <th>P2</th> <th>K2</th> <th>E2</th> <th>A2</th> </tr> </thead> <tbody> <tr> <td>$(dv_D/dt)_{crit,r}$ V/μs</td> <td>200</td> <td>320</td> <td>500</td> <td>1000</td> </tr> </tbody> </table> ²⁾ Turn-on time <table border="1"> <thead> <tr> <th>Symbol of group</th> <th>T4</th> <th>P4</th> <th>M4</th> <th>K4</th> </tr> </thead> <tbody> <tr> <td>$t_{gt,r}$ μs</td> <td>1.60</td> <td>2.00</td> <td>2.50</td> <td>3.20</td> </tr> </tbody> </table> ³⁾ Turn-off time ($dv_D/dt=50$ V/ μ s) <table border="1"> <thead> <tr> <th>Symbol of group</th> <th>X3</th> <th>T3</th> <th>P3</th> <th>M3</th> </tr> </thead> <tbody> <tr> <td>t_{qr} μs</td> <td>12.5</td> <td>16.0</td> <td>20.0</td> <td>25.0</td> </tr> </tbody> </table>					Symbol of group	P2	K2	E2	A2	$(dv_D/dt)_{crit,r}$ V/ μ s	200	320	500	1000	Symbol of group	T4	P4	M4	K4	$t_{gt,r}$ μ s	1.60	2.00	2.50	3.20	Symbol of group	X3	T3	P3	M3	t_{qr} μ s	12.5	16.0	20.0	25.0
Symbol of group	P2	K2	E2	A2																																						
$(dv_D/dt)_{crit,r}$ V/ μ s	200	320	500	1000																																						
Symbol of group	T4	P4	M4	K4																																						
$t_{gt,r}$ μ s	1.60	2.00	2.50	3.20																																						
Symbol of group	X3	T3	P3	M3																																						
t_{qr} μ s	12.5	16.0	20.0	25.0																																						
1	2	3	4	5	6	7	8																																			
1. TFI — fast inverter thyristor 2. Design version 3. Mean on-state current, A 4. Voltage code 5. Critical rate of rise of off-state voltage 6. Group of turn-off time ($dv_D/dt=50$ V/ μ s) 7. Group of turn-on time 8. Ambient conditions: N – normal; T – tropical																																										

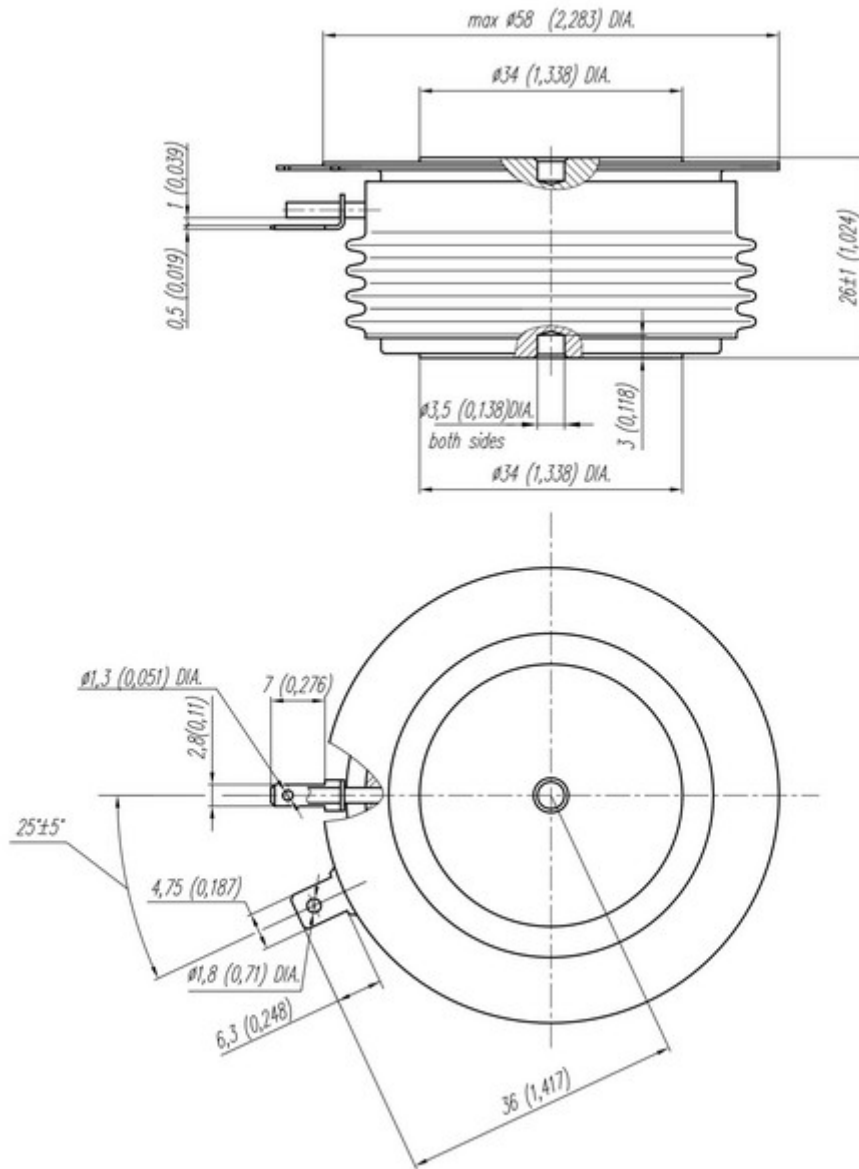

All dimensions in millimeters (inches)

The information contained herein is confidential and protected by Copyright. In the interest of product improvement, Proton-Electrotex reserves the right to change data sheet without notice.

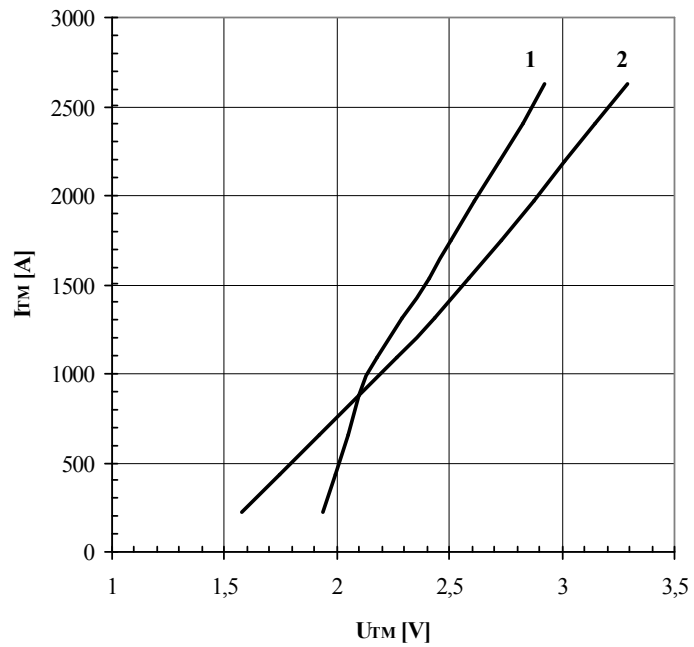
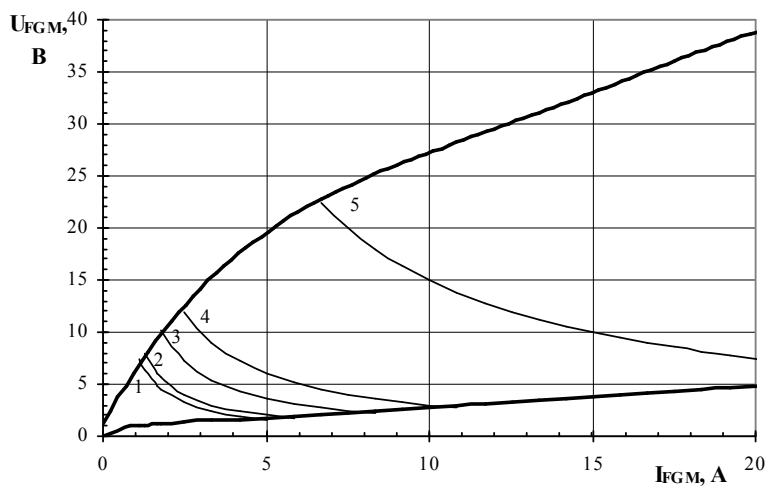

Fig. 1 On-state characteristics of Limit device
 1 – $T_j=25\text{ °C}$
 2 – $T_j=125\text{ °C}$



Maximum peak gate power loss

Position	On-Off time ratio	Gate pulse length, ms	Gate Pulse Power, W
1	1	DC	8
2	2	10	10
3	20	1	18
4	40	0.5	30
5	200	0.1	150

Fig. 2 Gate characteristics

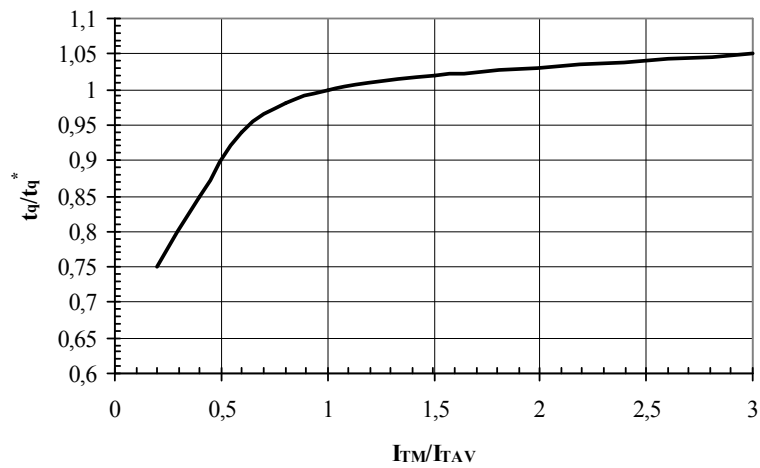

Fig. 3 Turn-off time t_q vs. On-state peak current I_{TM}

Conditions: $T_j=T_{j\ max}$; $di_R/dt=10\ A/\mu s$; $V_R=100\ V$; $dv_D/dt=50\ V/\mu s$; $V_D=0.67\cdot V_{DRM}$
 Typical changes of t_q are normalized to the t_q^* (t_q^* – see data sheet, $dv_D/dt=50\ V/\mu s$)

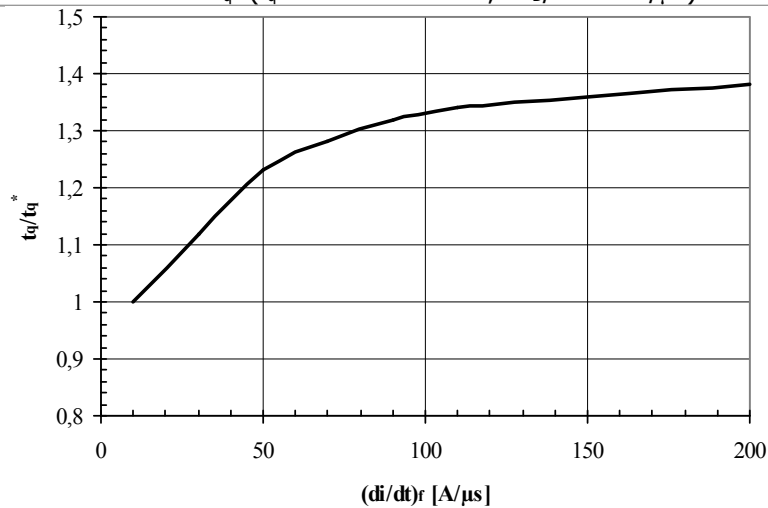

Fig. 4 Turn-off time t_q vs. Rate of fall of on-state current di_R/dt

Conditions: $T_j=T_{j\ max}$; $I_{TM}=I_{TAV}$; $V_R=100\ V$; $dv_D/dt=50\ V/\mu s$; $V_D=0.67\cdot V_{DRM}$
 Typical changes of t_q are normalized to the t_q^* (t_q^* – see data sheet, $dv_D/dt=50\ V/\mu s$)

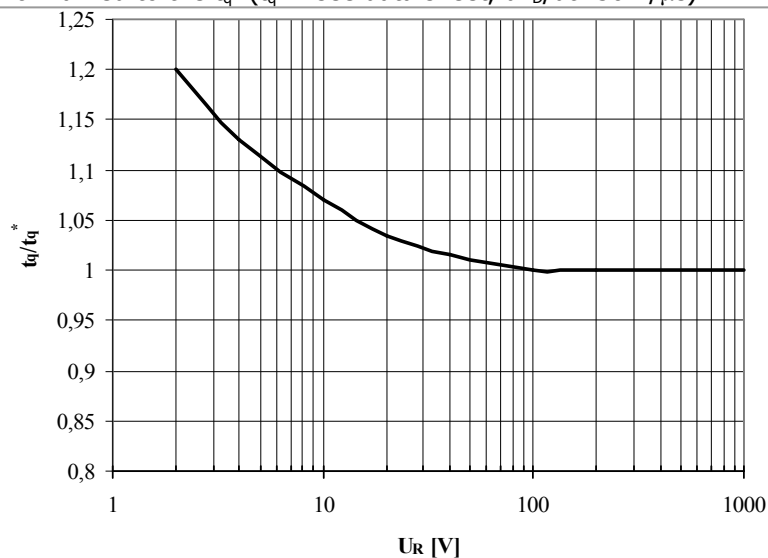

Fig. 5 Turn-off time t_q vs. Reverse voltage V_R

Conditions: $T_j=T_{j\ max}$; $I_{TM}=I_{TAV}$; $di_R/dt=10\ A/\mu s$; $dv_D/dt=50\ V/\mu s$; $V_D=0.67\cdot V_{DRM}$
 Typical changes of t_q are normalized to the t_q^* (t_q^* – see data sheet, $dv_D/dt=50\ V/\mu s$)

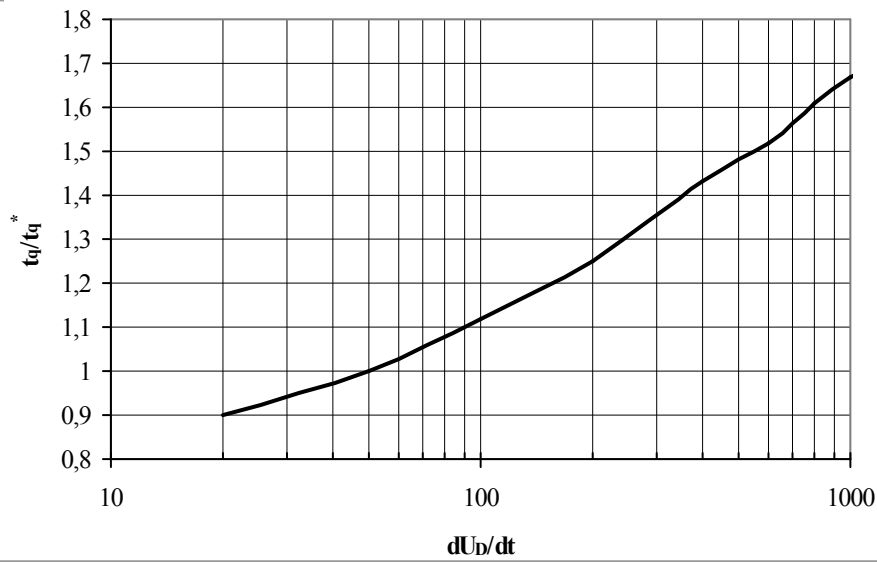

Fig. 6 Turn-off time t_q vs. Rate of rise of commutating voltage dv_D/dt

Conditions: $T_j=T_{j\max}$; $I_{TM}=I_{TAV}$; $di_R/dt=10\text{ A}/\mu\text{s}$; $V_R=100\text{ V}$; $V_D=0.67\cdot V_{DRM}$
 Typical changes of t_q are normalized to the t_q^* (t_q^* – see data sheet, $dv_D/dt=50\text{ V}/\mu\text{s}$)

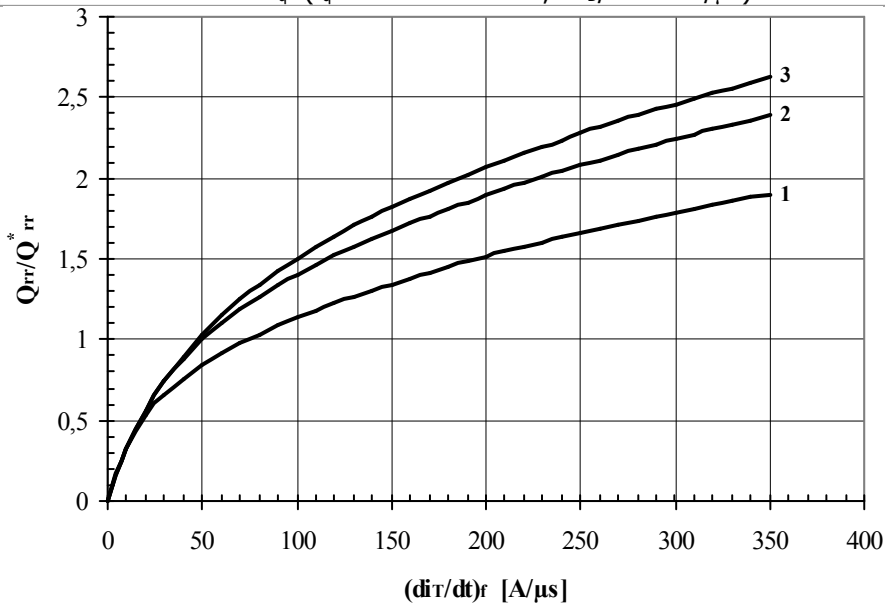

Fig. 7 Reverse recovery charge Q_{rr} vs. Rate of fall of on-state current di_r/dt

- 1 – $I_{TM} = 0.5 I_{TAV}$
- 2 – $I_{TM} = I_{TAV}$
- 3 – $I_{TM} = 1.5 I_{TAV}$

Conditions: $T_j=T_{j\max}$; $V_R=100\text{ V}$
 Typical changes of Q_{rr} are normalized to the Q_{rr}^* (Q_{rr}^* – see data sheet)

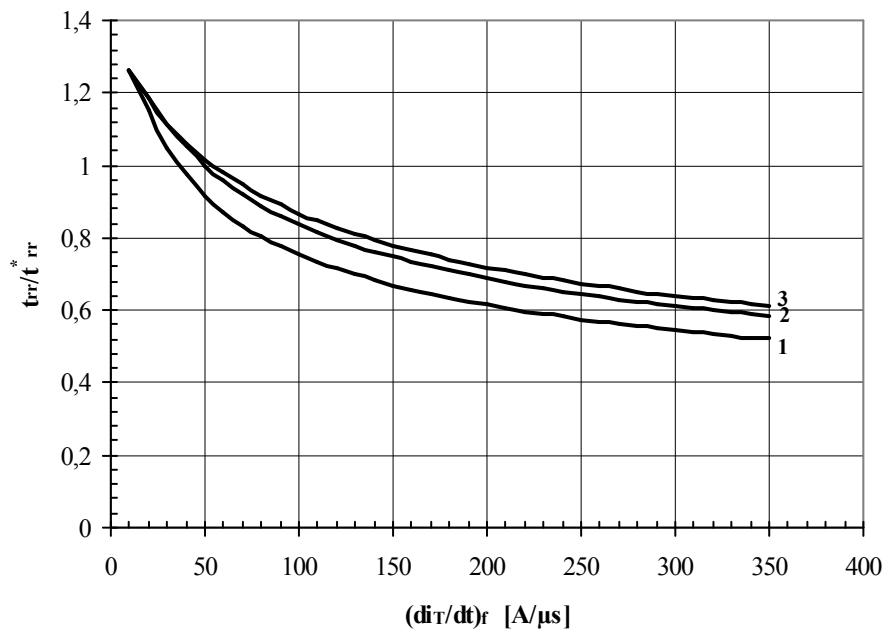

Fig. 8 Reverse recovery time t_{rr} vs. Rate of fall of on-state current di_r/dt

- 1 - $I_{TM} = 0.5 \cdot I_{TAV}$
- 2 - $I_{TM} = I_{TAV}$
- 3 - $I_{TM} = 1.5 \cdot I_{TAV}$

Conditions: $T_j = T_{j \max}$; $V_R = 100$ V

Typical changes of t_{rr} are normalized to the t_{rr}^* (t_{rr}^* – see data sheet)

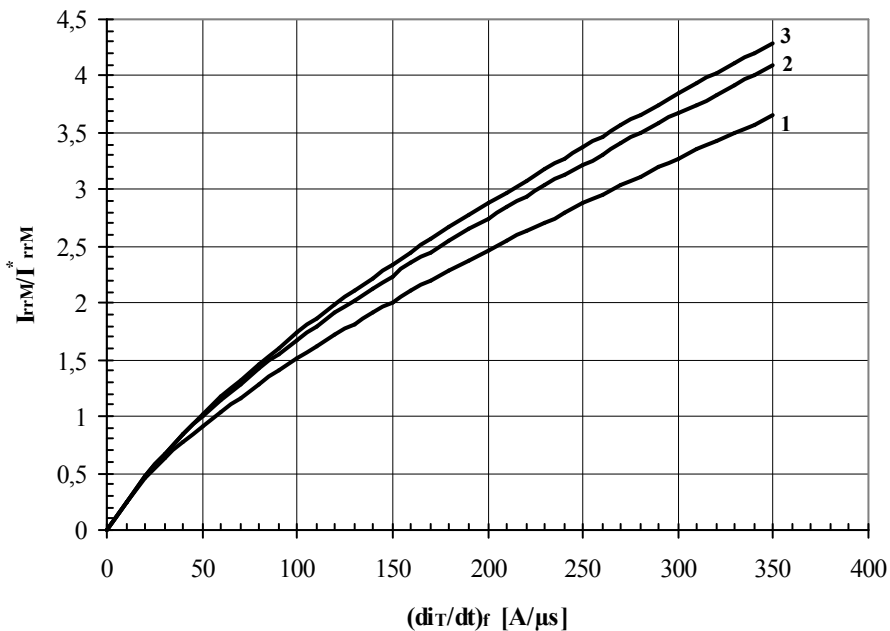

Fig. 9 Peak reverse recovery current I_{rrM} vs. Rate of fall of on-state current di_r/dt

- 1 - $I_{TM} = 0.5 \cdot I_{TAV}$
- 2 - $I_{TM} = I_{TAV}$
- 3 - $I_{TM} = 1.5 \cdot I_{TAV}$

Conditions: $T_j = T_{j \max}$; $V_R = 100$ V

Typical changes of I_{rrM} are normalized to the I_{rrM}^* (I_{rrM}^* – see data sheet)

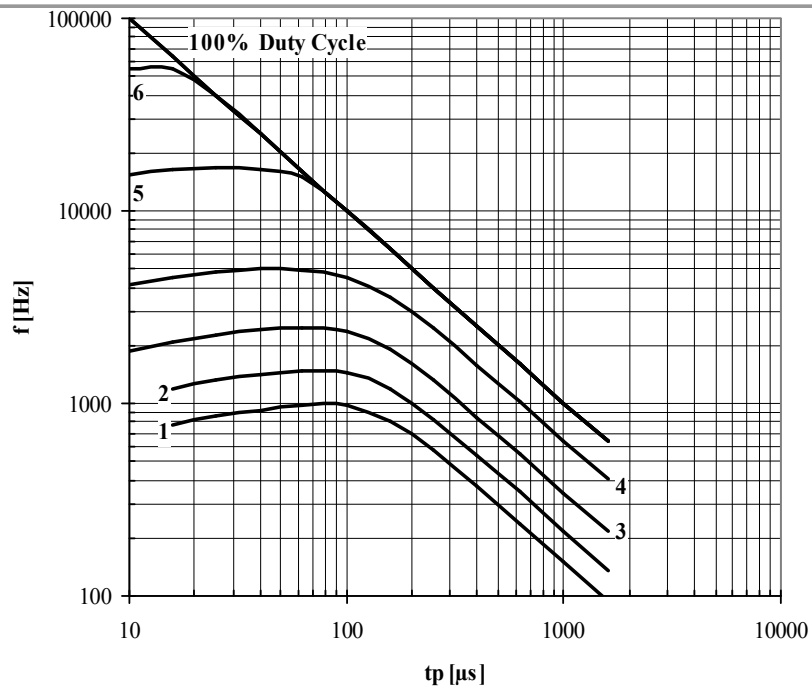

Fig. 10 Sine wave frequency ratings

- 1 - $I_{TM} = 5000 \text{ A}$
- 2 - $I_{TM} = 4000 \text{ A}$
- 3 - $I_{TM} = 3000 \text{ A}$
- 4 - $I_{TM} = 2000 \text{ A}$
- 5 - $I_{TM} = 1000 \text{ A}$
- 6 - $I_{TM} = 500 \text{ A}$

Conditions: $V_R \leq 3 \text{ V}$; $T_C = 55 \text{ }^\circ\text{C}$

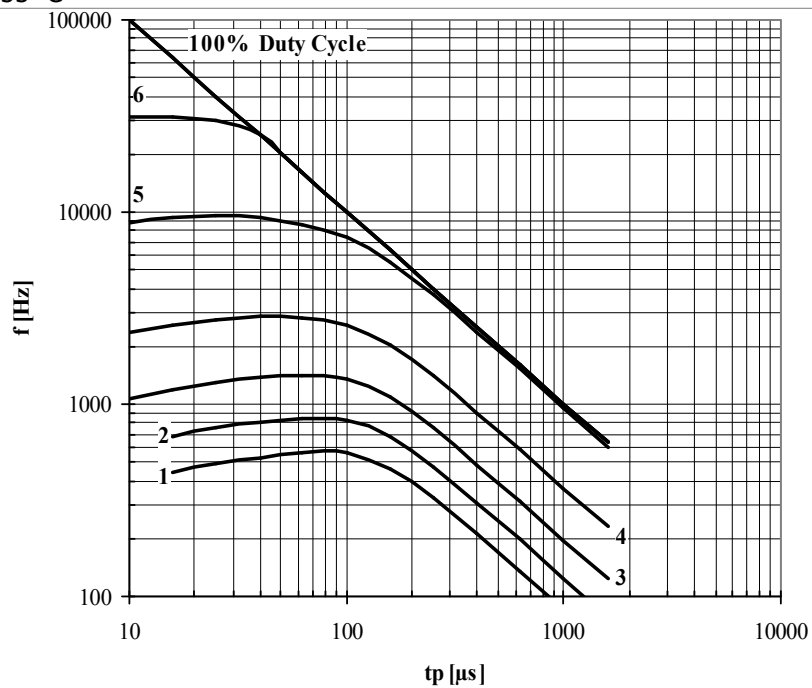

Fig. 11 Sine wave frequency ratings

- 1 - $I_{TM} = 5000 \text{ A}$
- 2 - $I_{TM} = 4000 \text{ A}$
- 3 - $I_{TM} = 3000 \text{ A}$
- 4 - $I_{TM} = 2000 \text{ A}$
- 5 - $I_{TM} = 1000 \text{ A}$
- 6 - $I_{TM} = 500 \text{ A}$
- 7 - $I_{TM} = 250 \text{ A}$

Conditions: $V_R \leq 3 \text{ V}$; $T_C = 85 \text{ }^\circ\text{C}$

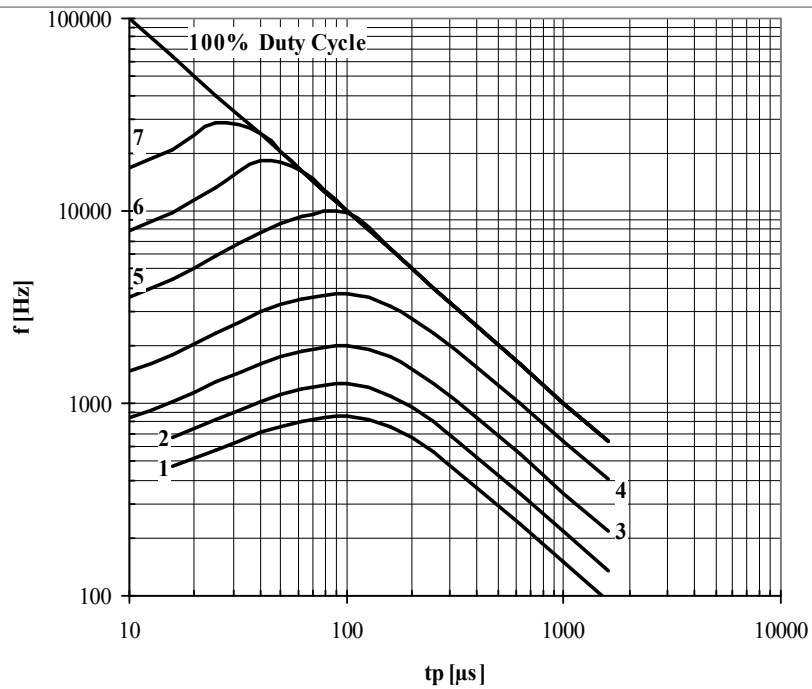

Fig. 12 Sine wave frequency ratings

- 1 - $I_{TM} = 5000 \text{ A}$
- 2 - $I_{TM} = 4000 \text{ A}$
- 3 - $I_{TM} = 3000 \text{ A}$
- 4 - $I_{TM} = 2000 \text{ A}$
- 5 - $I_{TM} = 1000 \text{ A}$
- 6 - $I_{TM} = 500 \text{ A}$
- 7 - $I_{TM} = 250 \text{ A}$

Conditions: $V_R = 0.67 \cdot V_{RRM}$; $T_C = 55 \text{ }^\circ\text{C}$

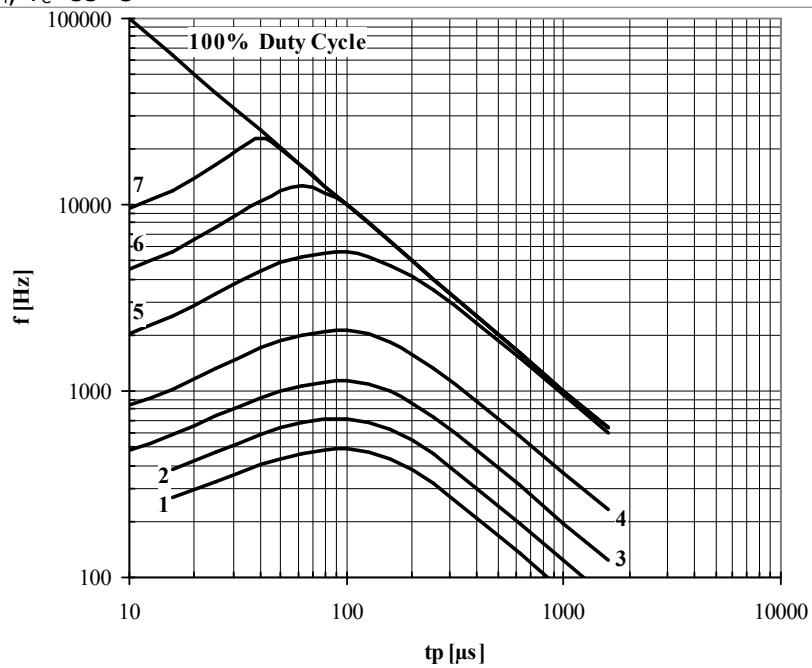

Fig. 13 Sine wave frequency ratings

- 1 - $I_{TM} = 5000 \text{ A}$
- 2 - $I_{TM} = 4000 \text{ A}$
- 3 - $I_{TM} = 3000 \text{ A}$
- 4 - $I_{TM} = 2000 \text{ A}$
- 5 - $I_{TM} = 1000 \text{ A}$
- 6 - $I_{TM} = 500 \text{ A}$
- 7 - $I_{TM} = 250 \text{ A}$

Conditions: $V_R = 0.67 \cdot V_{RRM}$; $T_C = 85 \text{ }^\circ\text{C}$

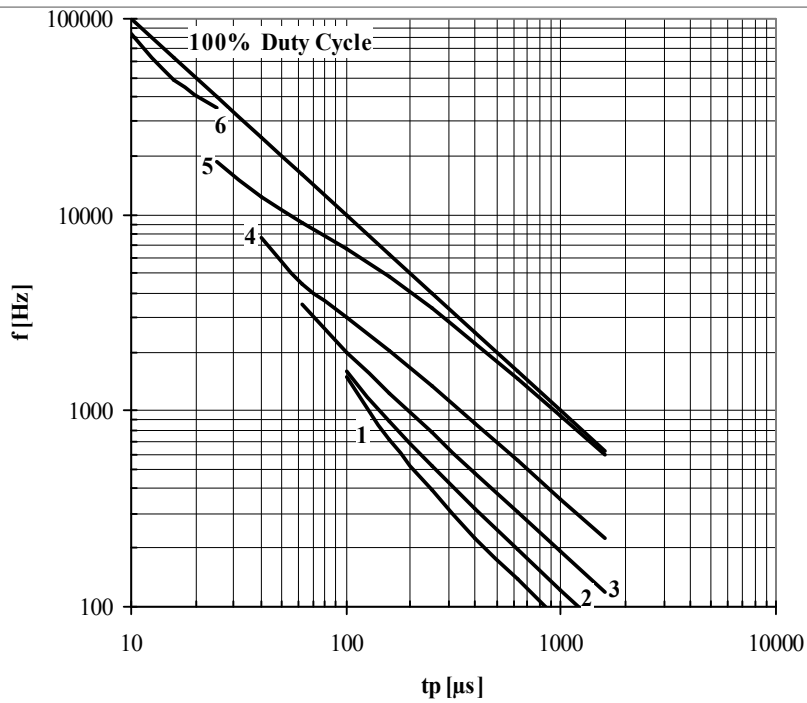

Fig. 14 Square wave frequency ratings

- 1 - $I_{TM} = 5000$ A
- 2 - $I_{TM} = 4000$ A
- 3 - $I_{TM} = 3000$ A
- 4 - $I_{TM} = 2000$ A
- 5 - $I_{TM} = 1000$ A
- 6 - $I_{TM} = 500$ A

Conditions: $V_R \leq 3$ V; $T_C = 55$ °C; $di_F/dt = di_R/dt = 100$ A/ μ s

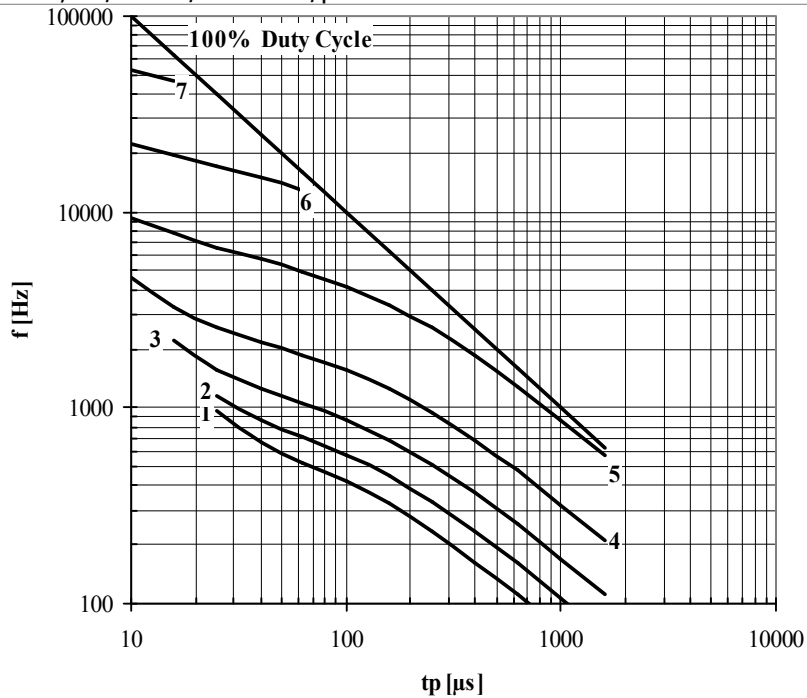

Fig. 15 Square wave frequency ratings

- 1 - $I_{TM} = 5000$ A
- 2 - $I_{TM} = 4000$ A
- 3 - $I_{TM} = 3000$ A
- 4 - $I_{TM} = 2000$ A
- 5 - $I_{TM} = 1000$ A
- 6 - $I_{TM} = 500$ A
- 7 - $I_{TM} = 250$ A

Conditions: $V_R \leq 3$ V; $T_C = 55$ °C; $di_F/dt = di_R/dt = 500$ A/ μ s

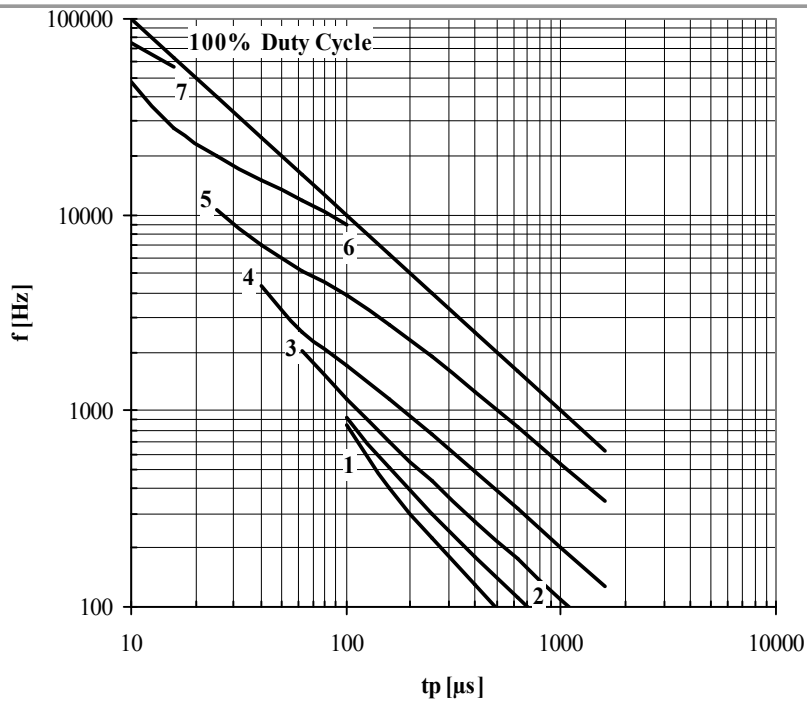

Fig. 16 Square wave frequency ratings

- 1 - $I_{TM} = 5000 \text{ A}$
- 2 - $I_{TM} = 4000 \text{ A}$
- 3 - $I_{TM} = 3000 \text{ A}$
- 4 - $I_{TM} = 2000 \text{ A}$
- 5 - $I_{TM} = 1000 \text{ A}$
- 6 - $I_{TM} = 500 \text{ A}$
- 7 - $I_{TM} = 250 \text{ A}$

Conditions: $V_R \leq 3 \text{ V}$; $T_C = 85 \text{ }^\circ\text{C}$; $di_F/dt = di_R/dt = 100 \text{ A}/\mu\text{s}$

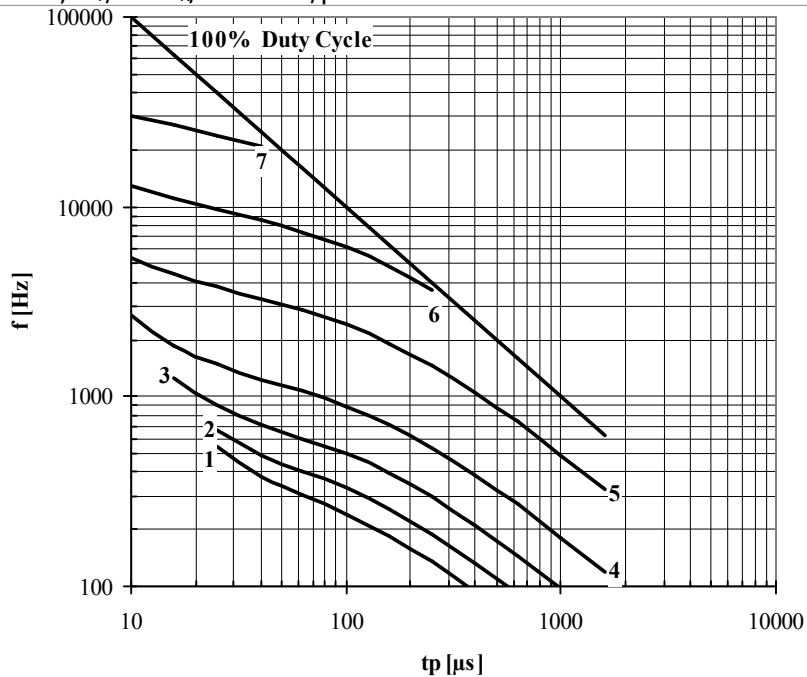

Fig. 17 Square wave frequency ratings

- 1 - $I_{TM} = 5000 \text{ A}$
- 2 - $I_{TM} = 4000 \text{ A}$
- 3 - $I_{TM} = 3000 \text{ A}$
- 4 - $I_{TM} = 2000 \text{ A}$
- 5 - $I_{TM} = 1000 \text{ A}$
- 6 - $I_{TM} = 500 \text{ A}$
- 7 - $I_{TM} = 250 \text{ A}$

Conditions: $V_R \leq 3 \text{ V}$; $T_C = 85 \text{ }^\circ\text{C}$; $di_F/dt = di_R/dt = 500 \text{ A}/\mu\text{s}$

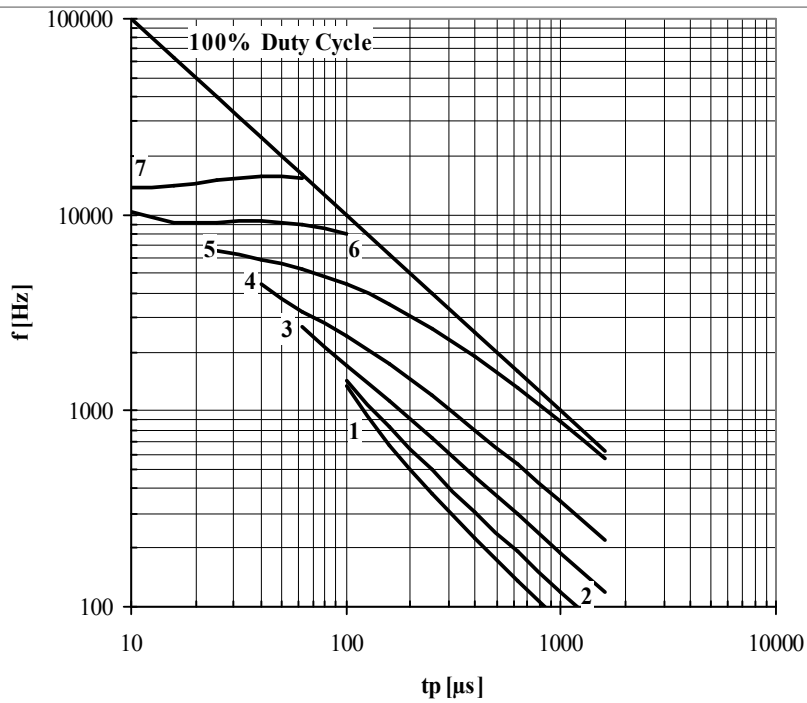

Fig. 18 Square wave frequency ratings

- 1 - $I_{TM} = 5000$ A
- 2 - $I_{TM} = 4000$ A
- 3 - $I_{TM} = 3000$ A
- 4 - $I_{TM} = 2000$ A
- 5 - $I_{TM} = 1000$ A
- 6 - $I_{TM} = 500$ A
- 7 - $I_{TM} = 250$ A

Conditions: $V_R = 0.67 \cdot V_{RRM}$; $T_C = 55$ °C; $di_F/dt = di_R/dt = 100$ A/ μ s

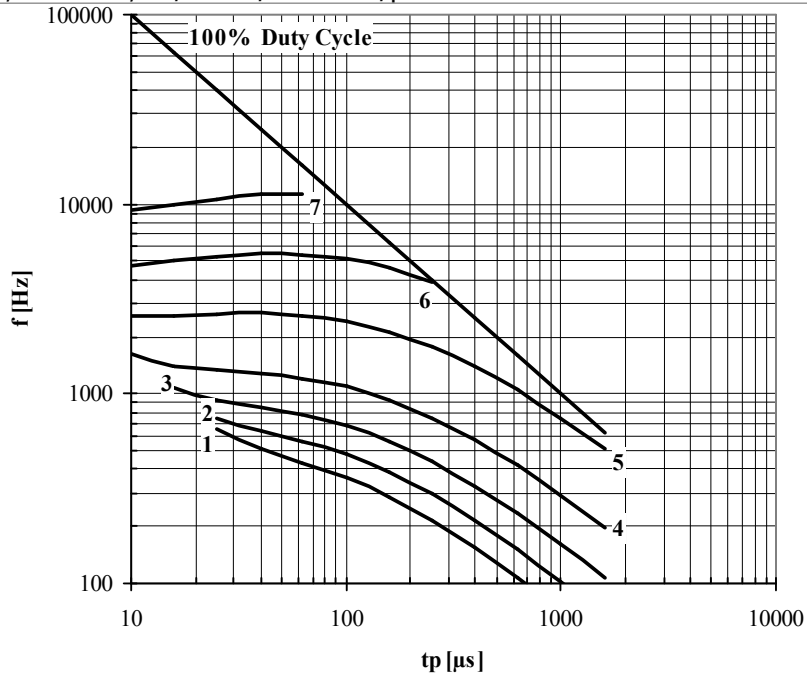

Fig. 19 Square wave frequency ratings

- 1 - $I_{TM} = 5000$ A
- 2 - $I_{TM} = 4000$ A
- 3 - $I_{TM} = 3000$ A
- 4 - $I_{TM} = 2000$ A
- 5 - $I_{TM} = 1000$ A
- 6 - $I_{TM} = 500$ A
- 7 - $I_{TM} = 250$ A

Conditions: $V_R = 0.67 \cdot V_{RRM}$; $T_C = 55$ °C; $di_F/dt = di_R/dt = 500$ A/ μ s

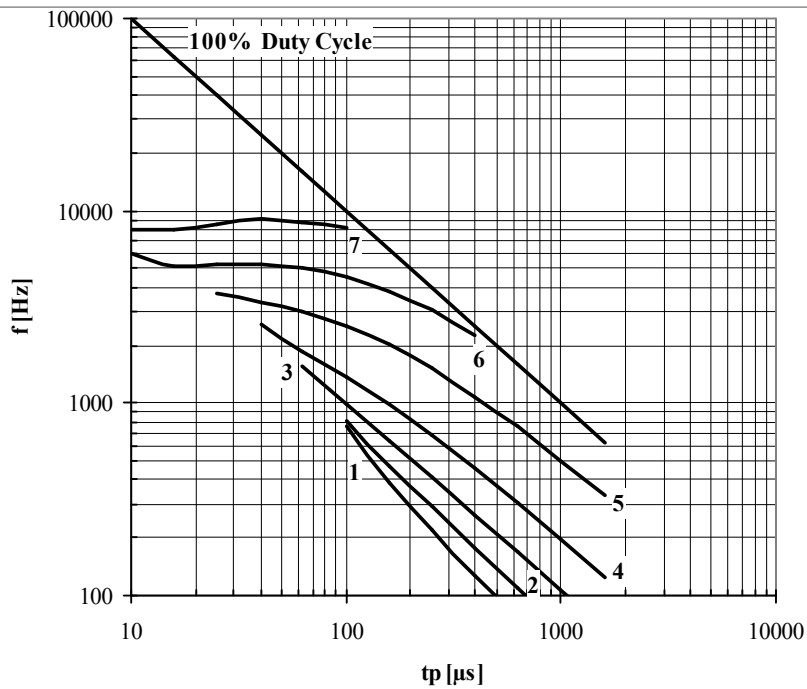

Fig. 20 Square wave frequency ratings

- 1 - $I_{TM} = 5000$ A
- 2 - $I_{TM} = 4000$ A
- 3 - $I_{TM} = 3000$ A
- 4 - $I_{TM} = 2000$ A
- 5 - $I_{TM} = 1000$ A
- 6 - $I_{TM} = 500$ A
- 7 - $I_{TM} = 250$ A

Conditions: $V_R=0.67 \cdot V_{RRM}$; $T_C=85$ °C; $di_F/dt=di_R/dt=100$ A/ μ s

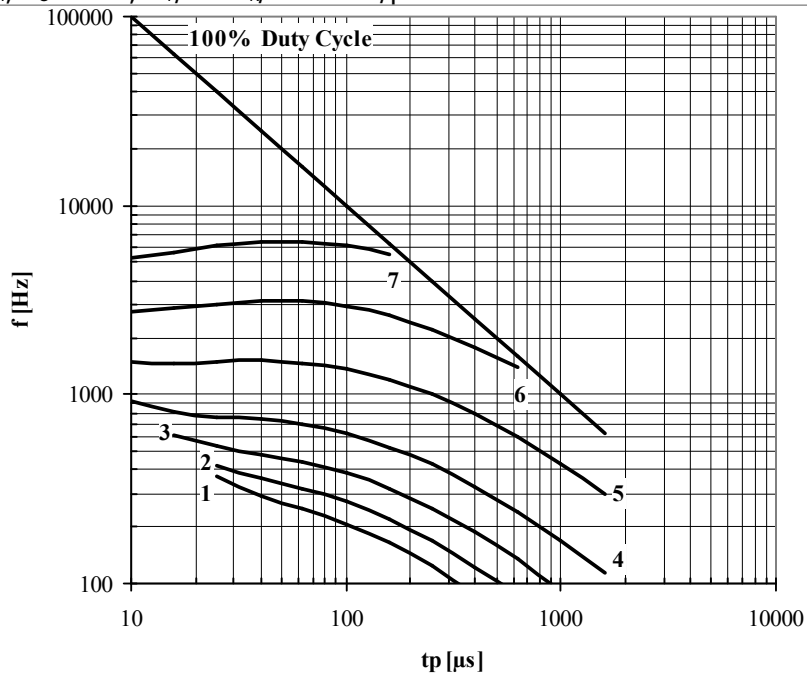

Fig. 21 Square wave frequency ratings

- 1 - $I_{TM} = 5000$ A
- 2 - $I_{TM} = 4000$ A
- 3 - $I_{TM} = 3000$ A
- 4 - $I_{TM} = 2000$ A
- 5 - $I_{TM} = 1000$ A
- 6 - $I_{TM} = 500$ A
- 7 - $I_{TM} = 250$ A

Conditions: $V_R=0.67 \cdot V_{RRM}$; $T_C=85$ °C; $di_F/dt=di_R/dt=500$ A/ μ s

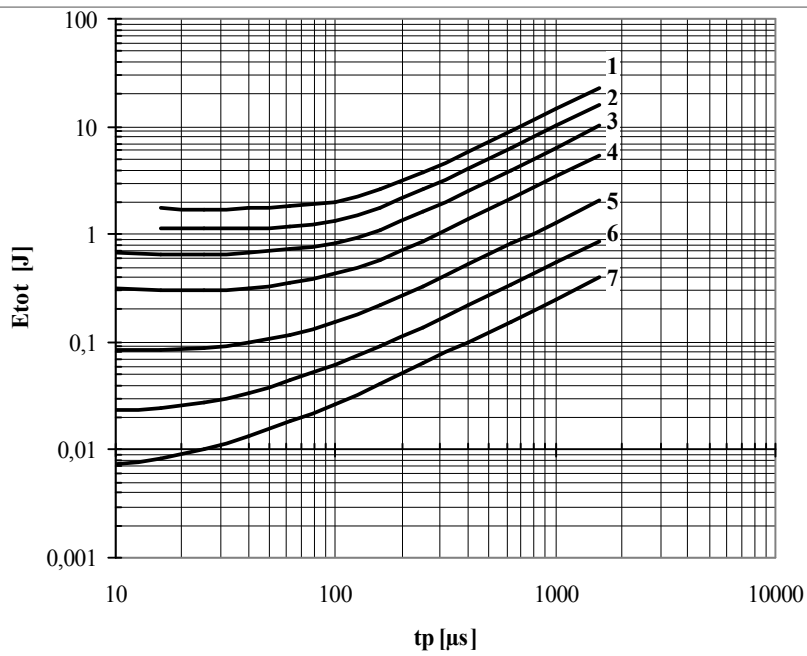

Fig. 22 Sine wave loss energy per pulse

- 1 - $I_{TM} = 5000$ A
- 2 - $I_{TM} = 4000$ A
- 3 - $I_{TM} = 3000$ A
- 4 - $I_{TM} = 2000$ A
- 5 - $I_{TM} = 1000$ A
- 6 - $I_{TM} = 500$ A
- 7 - $I_{TM} = 250$ A

Conditions: $V_R \leq 3$ V

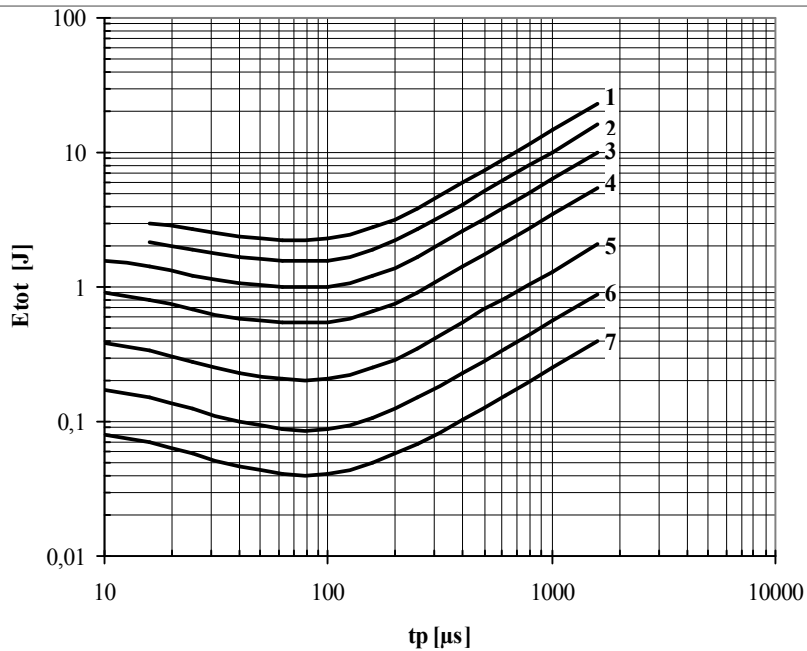

Fig. 23 Sine wave loss energy per pulse

- 1 - $I_{TM} = 5000$ A
- 2 - $I_{TM} = 4000$ A
- 3 - $I_{TM} = 3000$ A
- 4 - $I_{TM} = 2000$ A
- 5 - $I_{TM} = 1000$ A
- 6 - $I_{TM} = 500$ A
- 7 - $I_{TM} = 250$ A

Conditions: $V_R = 0.67 \cdot V_{RRM}$

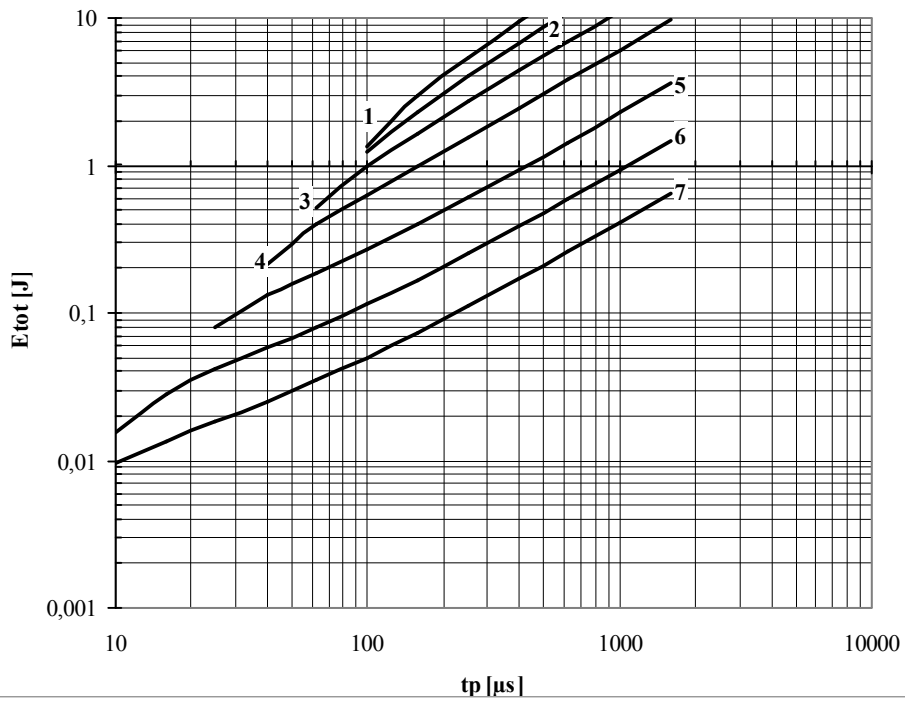

Fig. 24 Square wave loss energy per pulse

- 1 - $I_{TM} = 5000$ A
- 2 - $I_{TM} = 4000$ A
- 3 - $I_{TM} = 3000$ A
- 4 - $I_{TM} = 2000$ A
- 5 - $I_{TM} = 1000$ A
- 6 - $I_{TM} = 500$ A
- 7 - $I_{TM} = 250$ A

Conditions: $V_R \leq 3$ V; $di_F/dt = di_R/dt = 100$ A/ μ s

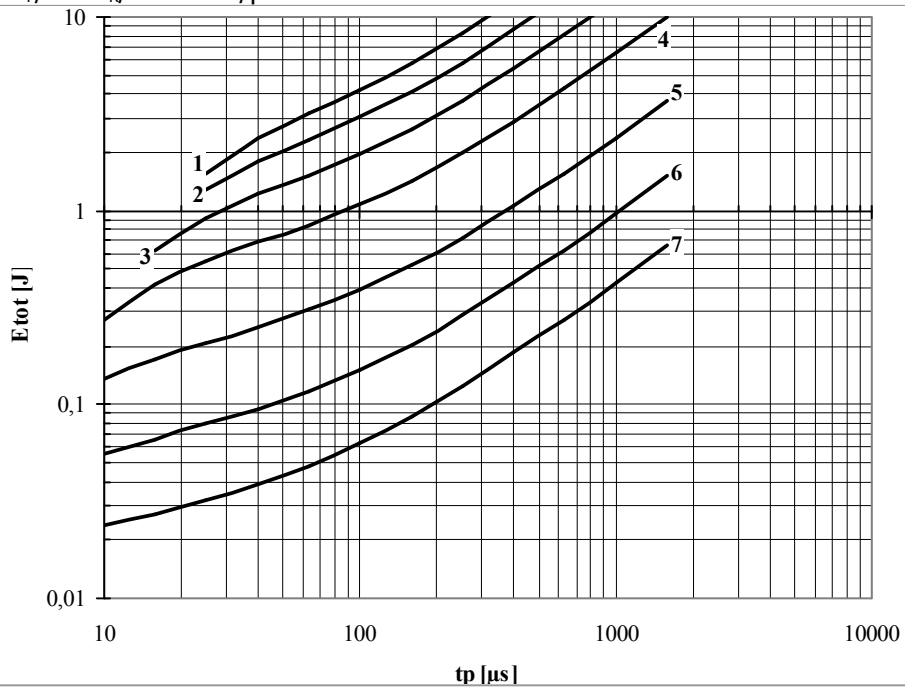

Fig. 25 Square wave loss energy per pulse

- 1 - $I_{TM} = 5000$ A
- 2 - $I_{TM} = 4000$ A
- 3 - $I_{TM} = 3000$ A
- 4 - $I_{TM} = 2000$ A
- 5 - $I_{TM} = 1000$ A
- 6 - $I_{TM} = 500$ A
- 7 - $I_{TM} = 250$ A

Conditions: $V_R \leq 3$ V; $di_F/dt = di_R/dt = 500$ A/ μ s

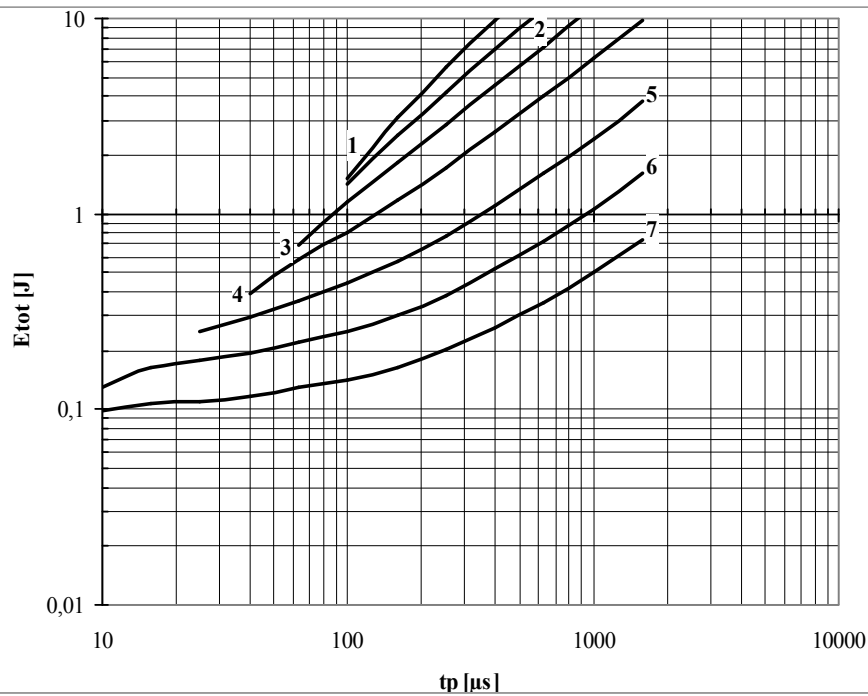

Fig. 26 Square wave loss energy per pulse

- 1 - $I_{TM} = 5000$ A
- 2 - $I_{TM} = 4000$ A
- 3 - $I_{TM} = 3000$ A
- 4 - $I_{TM} = 2000$ A
- 5 - $I_{TM} = 1000$ A
- 6 - $I_{TM} = 500$ A
- 7 - $I_{TM} = 250$ A

Conditions: $V_R = 0.67 \cdot V_{RRM}$; $di_F/dt = di_R/dt = 100$ A/ μ s

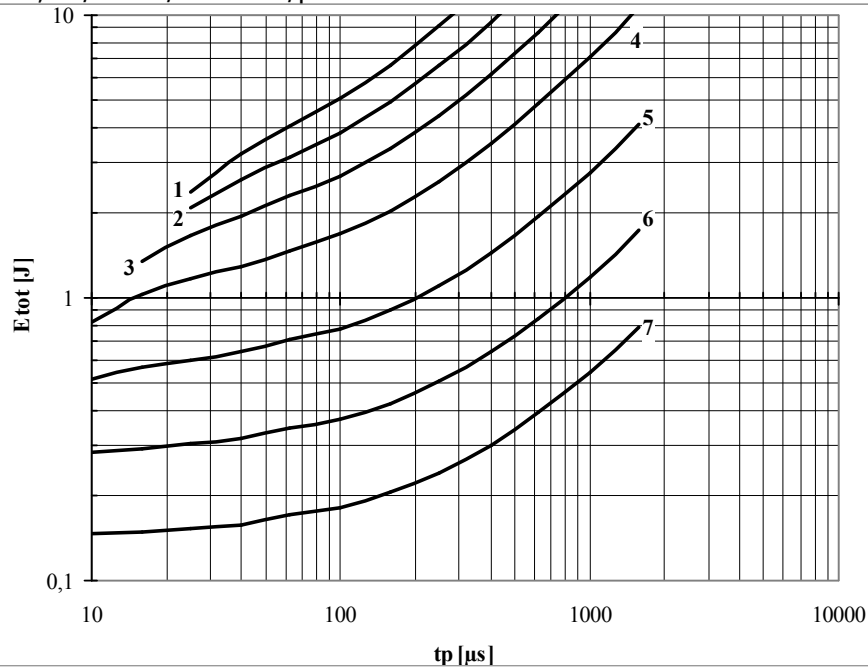

Fig. 27 Square wave loss energy per pulse

- 1 - $I_{TM} = 5000$ A
- 2 - $I_{TM} = 4000$ A
- 3 - $I_{TM} = 3000$ A
- 4 - $I_{TM} = 2000$ A
- 5 - $I_{TM} = 1000$ A
- 6 - $I_{TM} = 500$ A
- 7 - $I_{TM} = 250$ A

Conditions: $V_R = 0.67 \cdot V_{RRM}$; $di_F/dt = di_R/dt = 500$ A/ μ s

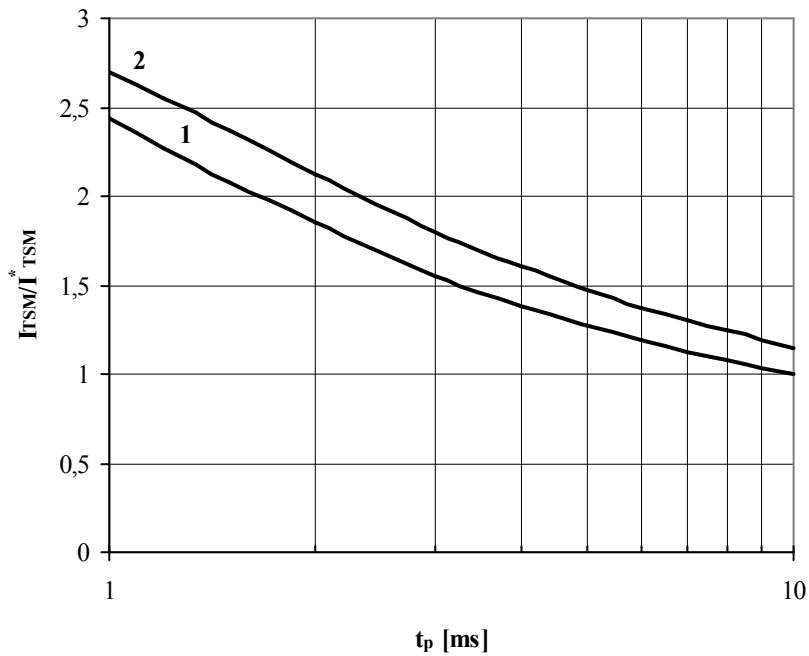

Fig. 28 The surge current I_{TSM} vs. Duration of surge t_p for a half-sine wave
 1 – $T_j=125\text{ °C}$
 2 – $T_j=25\text{ °C}$

Conditions: $V_R=0\text{ V}$ – the peak value of reverse voltage which is applied immediately after the surge current
 Typical changes of I_{TSM} are normalized to the I_{TSM}^* (I_{TSM}^* – see data sheet, $T_j=T_{j,max}$)

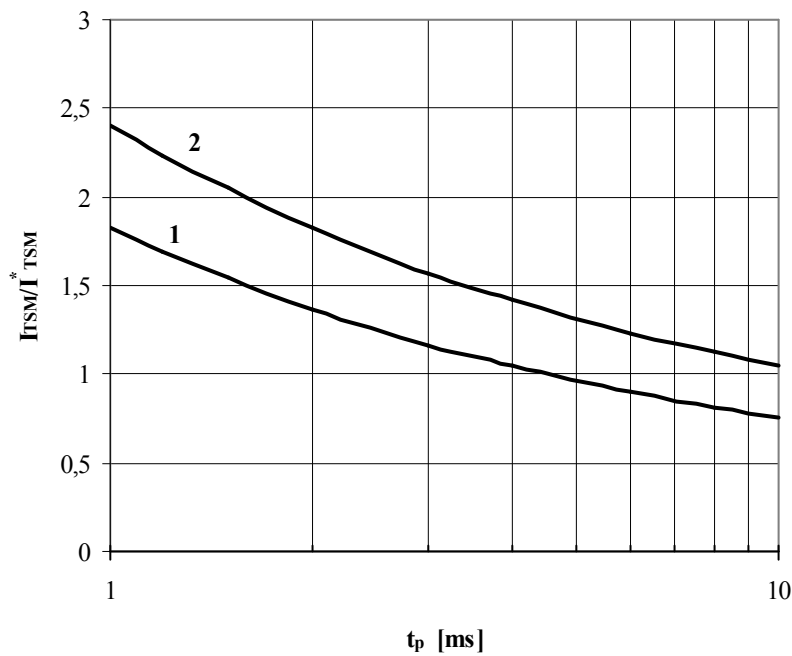

Fig. 29 The surge current I_{TSM} vs. Duration of surge t_p for a half-sine wave
 1 – $T_j=125\text{ °C}$
 2 – $T_j=25\text{ °C}$

Conditions: $V_R=0.8\cdot V_{RRM}$ – the peak value of reverse voltage which is applied immediately after the surge current
 Typical changes of I_{TSM} are normalized to the I_{TSM}^* (I_{TSM}^* – see data sheet, $T_j=T_{j,max}$)

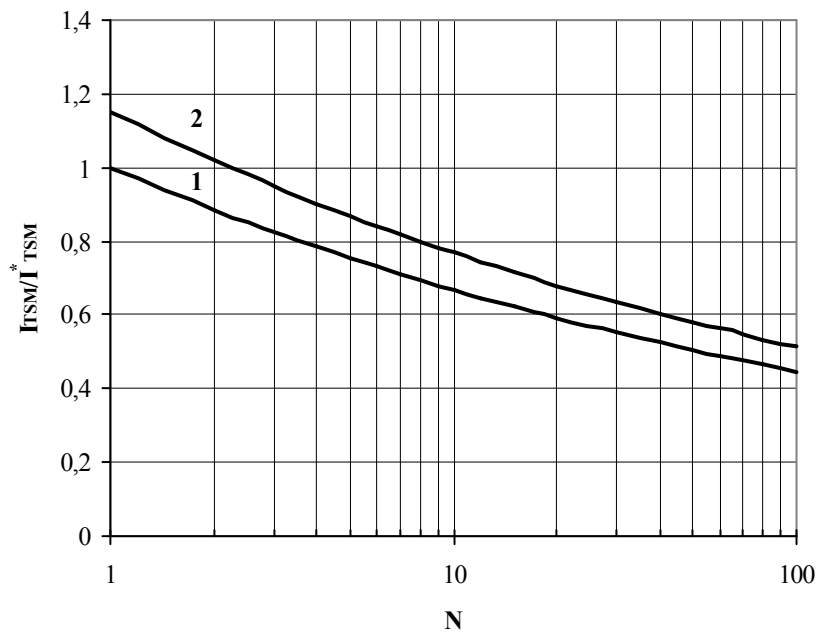

Fig. 30 The surge current I_{TSM} vs. Number of half-sine waves at 50 Hz

1 – $T_j=125\text{ }^\circ\text{C}$

2 – $T_j=25\text{ }^\circ\text{C}$

Conditions: $V_R=0\text{ V}$ – the peak value of reverse voltage which is applied immediately after the surge current
 Typical changes of I_{TSM} are normalized to the I_{TSM}^* (I_{TSM}^* – see data sheet, $T_j=T_{j\text{ max}}$)

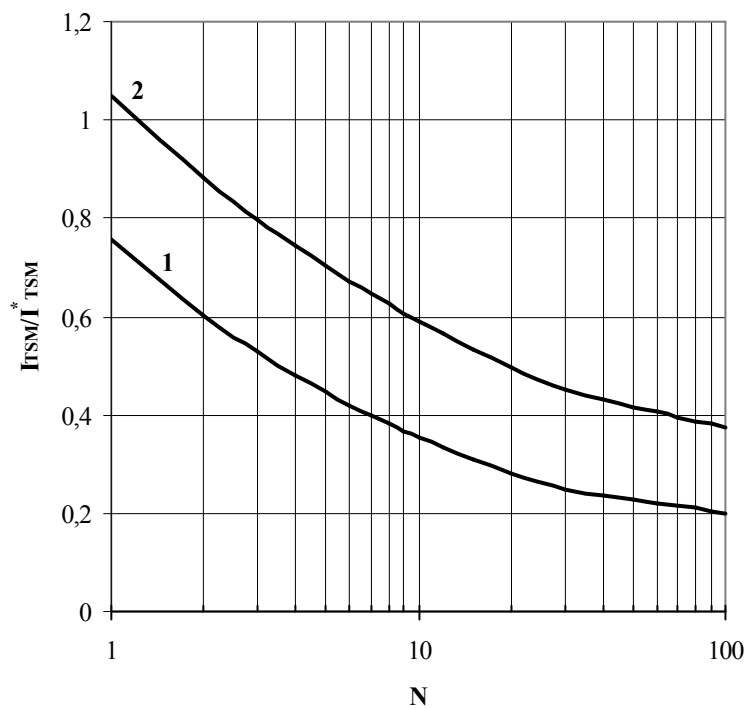

Fig. 31 The surge current I_{TSM} vs. Number of half-sine waves at 50 Hz

1 – $T_j=125\text{ }^\circ\text{C}$

2 – $T_j=25\text{ }^\circ\text{C}$

Conditions: $V_R=0.8 \cdot V_{RRM}$ – the peak value of reverse voltage which is applied immediately after the surge current
 Typical changes of I_{TSM} are normalized to the I_{TSM}^* (I_{TSM}^* – see data sheet, $T_j=T_{j\text{ max}}$)