



**Fast Thyristor
Type TFI233-320-24**

Low switching losses
Low reverse recovery charge
Distributed amplified gate for high di_T/dt

Mean on-state current	I_{TAV}	320 A	
Repetitive peak off-state voltage	V_{DRM}	2000 ÷ 2400 V	
Repetitive peak reverse voltage	V_{RRM}		
Turn-off time	t_q	25.0, 32.0, 40.0, 50.0 μs	
V_{DRM}, V_{RRM}, V	2000	2200	2400
Voltage code	20	22	24
$T_j, ^\circ C$	- 60 ÷ 125		

MAXIMUM ALLOWABLE RATINGS

Symbols and parameters		Units	Values	Test conditions
ON-STATE				
I_{TAV}	Mean on-state current	A	320 470	$T_c = 85^\circ C$; Double side cooled; $T_c = 55^\circ C$; Double side cooled; 180° half-sine wave; 50 Hz
I_{TRMS}	RMS on-state current	A	502	$T_c = 85^\circ C$; Double side cooled; 180° half-sine wave; 50 Hz
I_{TSM}	Surge on-state current	kA	6.3 7.0	$T_j = T_{jmax}$ $T_j = 25^\circ C$ 180° half-sine wave; $t_p = 10$ ms; single pulse; $V_D = V_R = 0$ V; Gate pulse: $I_G = I_{FGM}$; $V_G = 20$ V; $t_{GP} = 50 \mu s$; $di_G/dt = 1$ A/ μs
			6.5 7.5	$T_j = T_{jmax}$ $T_j = 25^\circ C$ 180° half-sine wave; $t_p = 8.3$ ms; single pulse; $V_D = V_R = 0$ V; Gate pulse: $I_G = I_{FGM}$; $V_G = 20$ V; $t_{GP} = 50 \mu s$; $di_G/dt = 1$ A/ μs
I^2t	Safety factor	$A^2s \cdot 10^3$	190 240	$T_j = T_{jmax}$ $T_j = 25^\circ C$ 180° half-sine wave; $t_p = 10$ ms; single pulse; $V_D = V_R = 0$ V; Gate pulse: $I_G = I_{FGM}$; $V_G = 20$ V; $t_{GP} = 50 \mu s$; $di_G/dt = 1$ A/ μs
			170 230	$T_j = T_{jmax}$ $T_j = 25^\circ C$ 180° half-sine wave; $t_p = 8.3$ ms; single pulse; $V_D = V_R = 0$ V; Gate pulse: $I_G = I_{FGM}$; $V_G = 20$ V; $t_{GP} = 50 \mu s$; $di_G/dt = 1$ A/ μs
BLOCKING				
V_{DRM}, V_{RRM}	Repetitive peak off-state and Repetitive peak reverse voltages	V	2000÷2400	$T_{jmin} < T_j < T_{jmax}$; 180° half-sine wave; 50 Hz; Gate open
V_{DSM}, V_{RSM}	Non-repetitive peak off-state and Non-repetitive peak reverse voltages	V	2100÷2500	$T_{jmin} < T_j < T_{jmax}$; 180° half-sine wave; single pulse; Gate open
V_D, V_R	Direct off-state and Direct reverse voltages	V	0.6 V_{DRM} 0.6 V_{RRM}	$T_j = T_{jmax}$; Gate open

TRIGGERING				
I_{FGM}	Peak forward gate current	A	6	$T_j = T_{j\ max}$
V_{RGM}	Peak reverse gate voltage	V	5	
P_G	Gate power dissipation	W	3	$T_j = T_{j\ max}$ for DC gate current
SWITCHING				
$(di_T/dt)_{crit}$	Critical rate of rise of on-state current non-repetitive (f=1 Hz)	A/ μ s	1600	$T_j = T_{j\ max}$; $V_D = 0.67 \cdot V_{DRM}$; $I_{TM} = 2 I_{TAV}$; Gate pulse: $I_G = I_{FGM}$; $V_G = 20$ V; $t_{GP} = 50$ μ s; $di_G/dt = 2$ A/ μ s
THERMAL				
T_{stg}	Storage temperature	$^{\circ}$ C	-60 \div 50	
T_j	Operating junction temperature	$^{\circ}$ C	-60 \div 125	
MECHANICAL				
F	Mounting force	kN	9.0 \div 11.0	
a	Acceleration	m/s ²	50	Device clamped

CHARACTERISTICS

Symbols and parameters		Units	Values	Conditions	
ON-STATE					
V_{TM}	Peak on-state voltage, max	V	2.60	$T_j = 25$ $^{\circ}$ C; $I_{TM} = 1005$ A	
$V_{T(TO)}$	On-state threshold voltage, max	V	1.50	$T_j = T_{j\ max}$;	
r_T	On-state slope resistance, max	m Ω	1.250	$0.5 \pi I_{TAV} < I_T < 1.5 \pi I_{TAV}$	
I_H	Holding current, max	mA	500	$T_j = 25$ $^{\circ}$ C; $V_D = 12$ V; Gate open	
BLOCKING					
I_{DRM}, I_{RRM}	Repetitive peak off-state and Repetitive peak reverse currents, max	mA	150	$T_j = T_{j\ max}$; $V_D = V_{DRM}$; $V_R = V_{RRM}$	
$(dv_D/dt)_{crit}$	Critical rate of rise of off-state voltage ¹⁾ , min	V/ μ s	200, 320, 500, 1000	$T_j = T_{j\ max}$; $V_D = 0.67 \cdot V_{DRM}$; Gate open	
TRIGGERING					
V_{GT}	Gate trigger direct voltage, max	V	4.00 2.50 2.00	$T_j = T_{j\ min}$ $T_j = 25$ $^{\circ}$ C $T_j = T_{j\ max}$	$V_D = 12$ V; $I_D = 3$ A; Direct gate current
I_{GT}	Gate trigger direct current, max	mA	500 300 200	$T_j = T_{j\ min}$ $T_j = 25$ $^{\circ}$ C $T_j = T_{j\ max}$	
V_{GD}	Gate non-trigger direct voltage, min	V	0.25	$T_j = T_{j\ max}$; $V_D = 0.67 \cdot V_{DRM}$;	
I_{GD}	Gate non-trigger direct current, min	mA	10.00	Direct gate current	
SWITCHING					
t_{gd}	Delay time, max	μ s	0.60	$T_j = 25$ $^{\circ}$ C; $V_D = 1000$ V; $I_{TM} = I_{TAV}$; $di/dt = 200$ A/ μ s;	
t_{gt}	Turn-on time ²⁾	μ s	1.60, 2.00, 2.50, 3.20	Gate pulse: $I_G = I_{FGM}$; $V_G = 20$ V; $t_{GP} = 50$ μ s; $di_G/dt = 2$ A/ μ s	
t_q	Turn-off time ³⁾ max	μ s	25.0, 32.0, 40.0, 50.0 32.0, 40.0, 50.0, 63.0	$dv_D/dt = 50$ V/ μ s $dv_D/dt = 200$ V/ μ s	$T_j = T_{j\ max}$; $I_{TM} = I_{TAV}$; $di_R/dt = -10$ A/ μ s; $V_R = 100$ V; $V_D = 0.67 V_{DRM}$
Q_{rr}	Total recovered charge, max	μ C	250	$T_j = T_{j\ max}$; $I_{TM} = 320$ A;	
t_{rr}	Reverse recovery time, typ	μ s	4.0	$di_R/dt = -50$ A/ μ s;	
I_{rrM}	Peak reverse recovery current, max	A	130	$V_R = 100$ V	

THERMAL					
R_{thjc}	Thermal resistance, junction to case, max	°C/W	0.0500	Direct current	Double side cooled
R_{thjc-A}			0.1100		Anode side cooled
R_{thjc-K}			0.0900		Cathode side cooled
R_{thck}	Thermal resistance, case to heatsink, max	°C/W	0.0060	Direct current	
MECHANICAL					
w	Weight, max	g	176		
D_s	Surface creepage distance	mm (inch)	19.44 (0.765)		
D_a	Air strike distance	mm (inch)	12.10 (0.476)		

PART NUMBERING GUIDE								NOTES						
TFI	233	320	24	A2	M3	T4	N	1) Critical rate of rise of off-state voltage						
1	2	3	4	5	6	7	8	Symbol of group	P2	K2	E2	A2		
1. TFI — fast inverter thyristor								$(dv_D/dt)_{crit,r}$ V/μs	200	320	500	1000		
2. Design version								2) Turn-on time						
3. Mean on-state current, A								Symbol of group	T4	P4	M4	K4		
4. Voltage code								$t_{gt,r}$ μs	1.60	2.00	2.50	3.20		
5. Critical rate of rise of off-state voltage								3) Turn-off time ($dv_D/dt=50$ V/μs)						
6. Group of turn-off time ($dv_D/dt=50$ V/μs)								Symbol of group	M3	K3	H3	E3		
7. Group of turn-on time								t_{qr} μs	25.0	32.0	40.0	50.0		
8. Ambient conditions: N – normal; T – tropical														

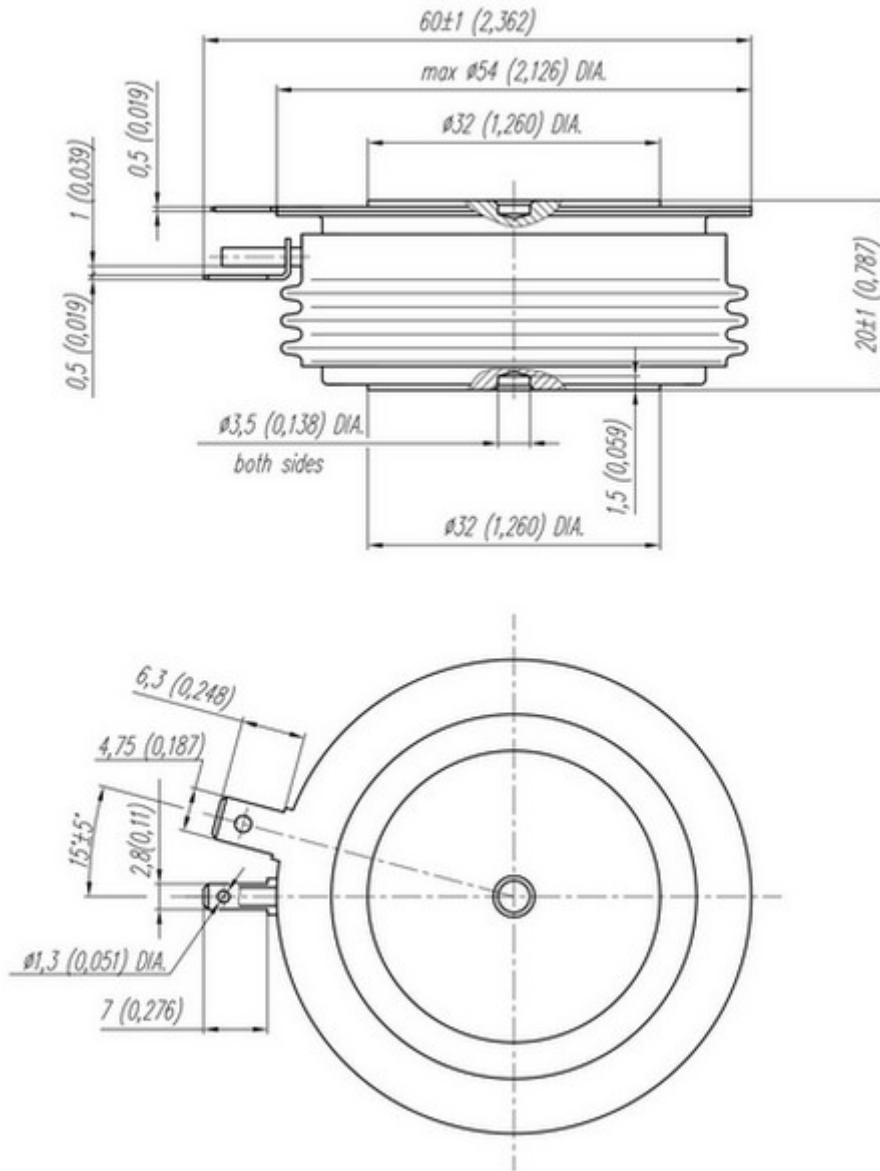

All dimensions in millimeters (inches)

The information contained herein is confidential and protected by Copyright. In the interest of product improvement, Proton-Electrotex reserves the right to change data sheet without notice.

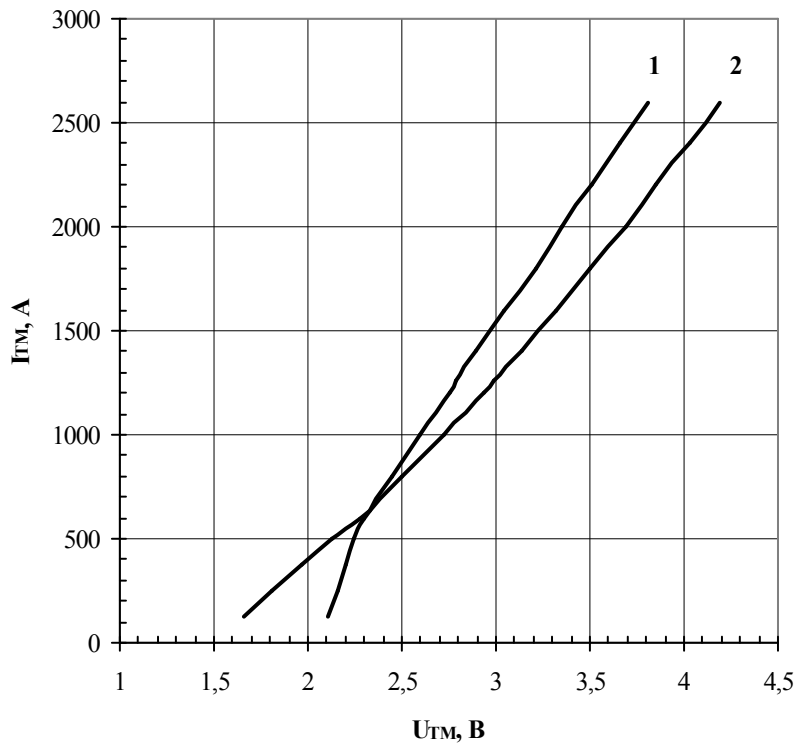

Fig. 1 On-state characteristics of Limit device
 1 – $T_j=25\text{ °C}$
 2 – $T_j=125\text{ °C}$

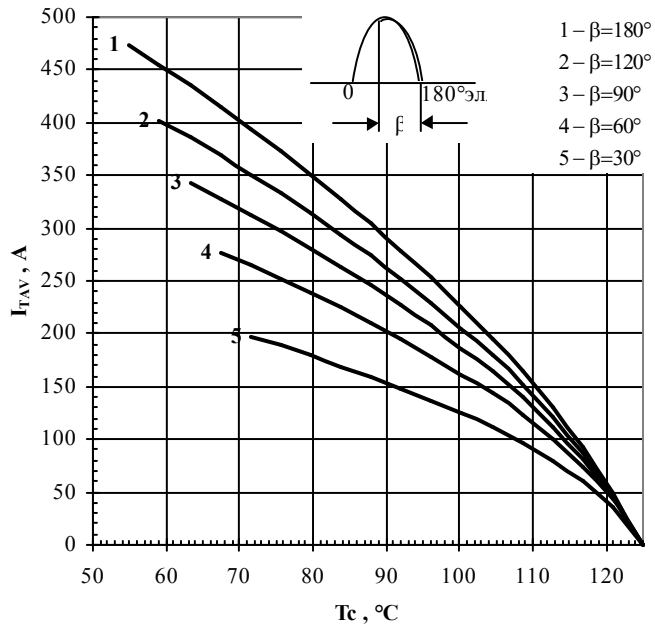

Fig. 2. Maximum allowable mean on-state current I_{TAV} vs. case temperature T_c for sinusoidal current waveforms, $f=50\text{ Hz}$

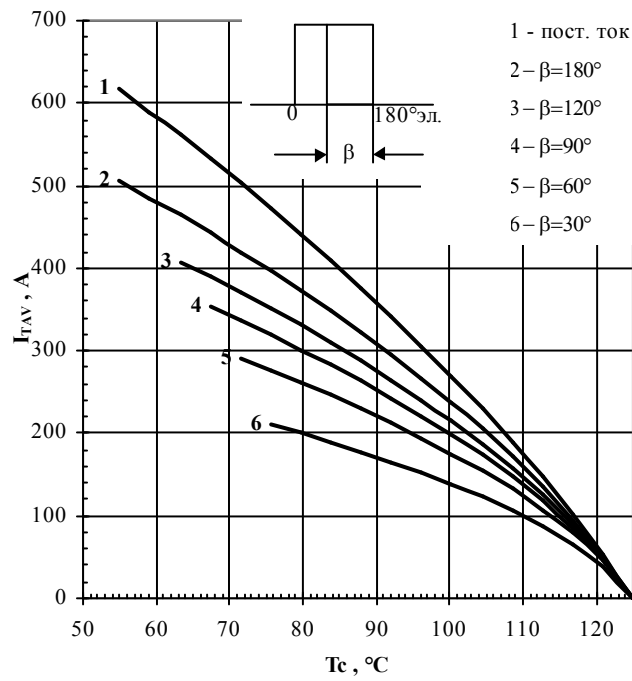

Fig. 3 Maximum allowable mean on-state current I_{TAV} vs. case temperature T_c for rectangular current waveforms and for DC, $f=50\text{Hz}$

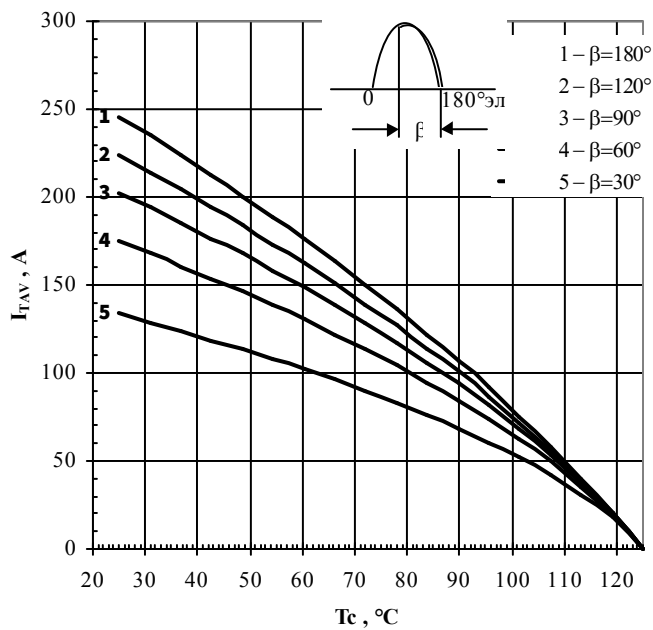

Fig. 4 Maximum allowable mean on-state current I_{TAV} vs. cooling temperature T_a for cooling air force 6 m/s, heatsink O143 and sinusoidal current waveforms at different conduction angles, $f=50\text{Hz}$

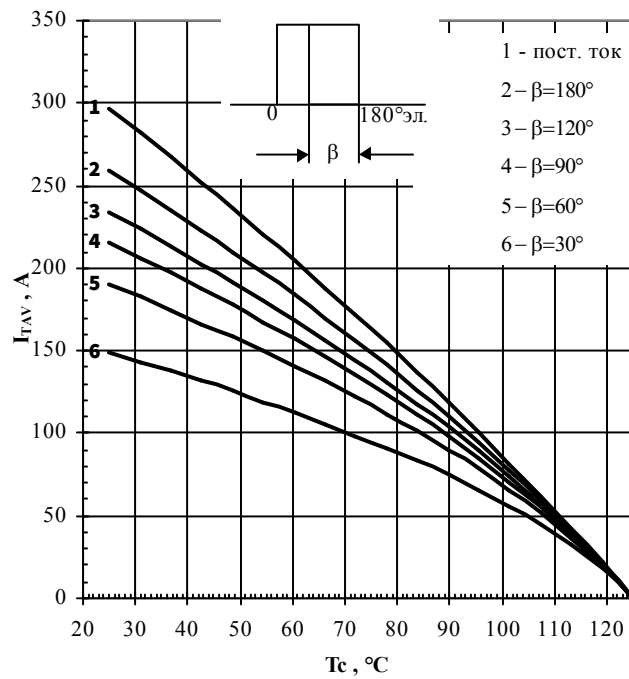

Fig. 5 Maximum allowable mean on-state current I_{TAV} vs. cooling temperature T_a for cooling air force 6 m/s, heatsink O143 and rectangular current waveforms at different conduction angles, $f=50\text{Hz}$

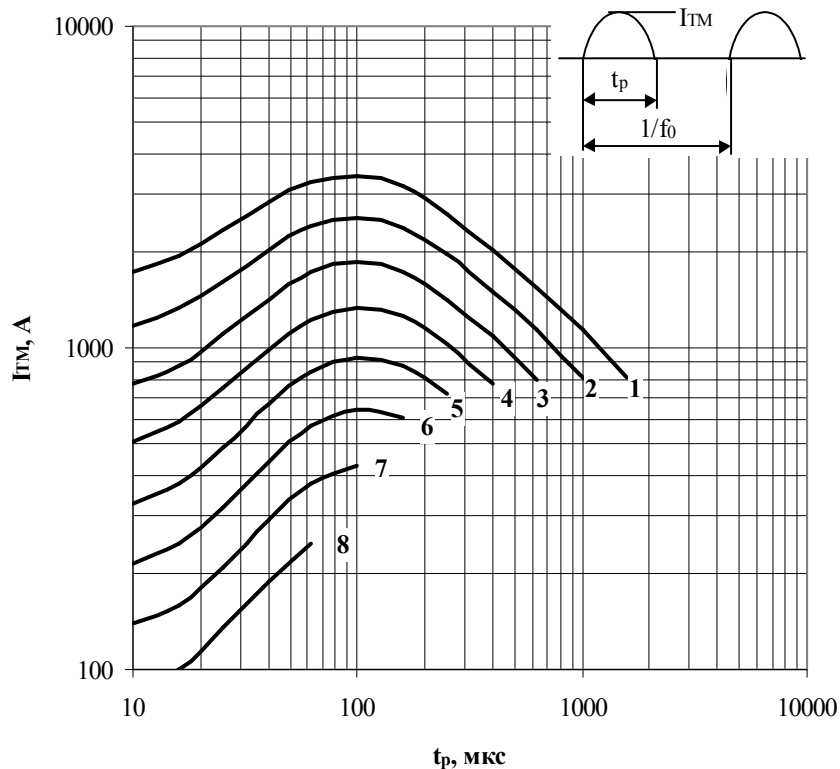

Fig. 6 Maximum allowable mean on-state current I_{TAV} of sinusoidal current waveform vs. pulse duration t_p for case temperature $T_c=65\text{ °C}$ at high frequency.

- 1 – 630 Hz;
- 2 – 1000 Hz;
- 3 – 1600 Hz;
- 4 – 2500 Hz;
- 5 – 4000 Hz;
- 6 – 6300 Hz;
- 7 – 10000 Hz;
- 8 – 16000 Hz.

Conditions: $V_D=0,67 \cdot V_{DRM}$; $V_R=0,67 \cdot V_{RRM}$.

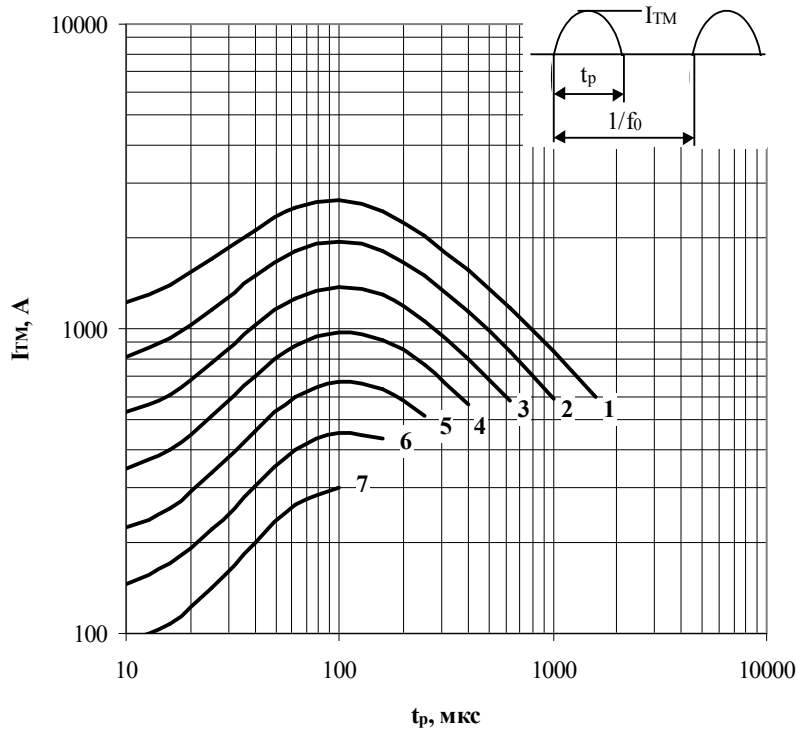

Fig. 7 Maximum allowable mean on-state current I_{TAV} of sinusoidal current waveform vs. pulse duration t_p for case temperature $T_c=85\text{ }^\circ\text{C}$ at high frequency.

- | | |
|--------------|---------------|
| 1 – 630 Hz; | 5 – 4000 Hz; |
| 2 – 1000 Hz; | 6 – 6300 Hz; |
| 3 – 1600 Hz; | 7 – 10000 Hz. |
| 4 – 2500 Hz; | |

Conditions: $V_D=0,67V_{DRM}$; $V_R=0,67V_{RRM}$.

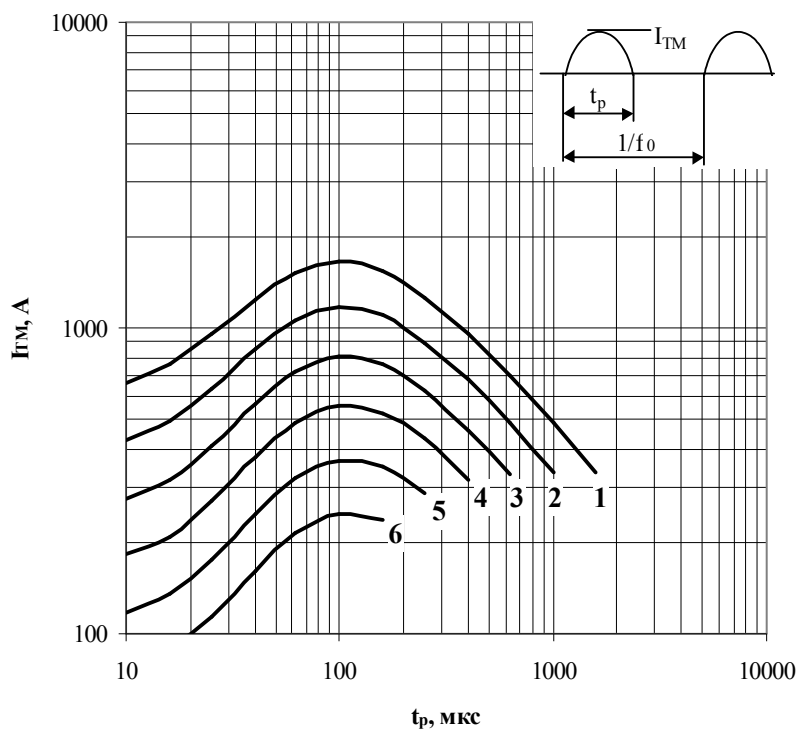

Fig. 8 Maximum allowable mean on-state current I_{TAV} of sinusoidal current waveform vs. pulse duration t_p for case temperature $T_c=105\text{ }^\circ\text{C}$ at high frequency

- | | |
|--------------|--------------|
| 1 – 630 Hz; | 4 – 2500 Hz; |
| 2 – 1000 Hz; | 5 – 4000 Hz; |
| 3 – 1600 Hz; | 6 – 6300 Hz. |

Conditions: $V_D=0,67V_{DRM}$; $V_R=0,67V_{RRM}$.

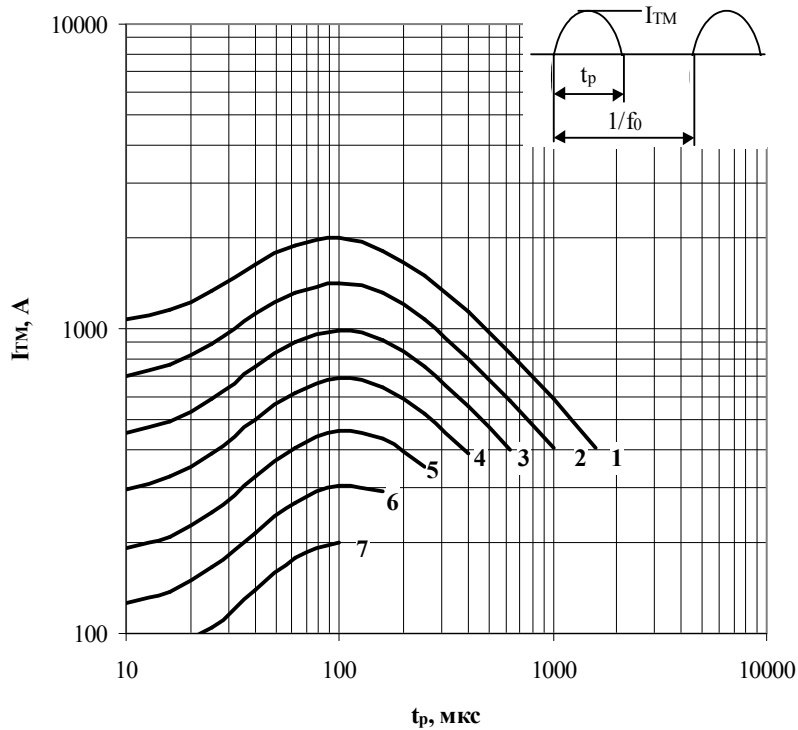

Fig. 9 Maximum allowable mean on-state current I_{TAV} of sinusoidal current waveform vs. pulse duration t_p for cooling temperature $T_a=40\text{ }^\circ\text{C}$, cooling air force 6 m/s, heat sink 0143 at high frequency.

- | | |
|--------------|---------------|
| 1 – 630 Hz; | 5 – 4000 Hz; |
| 2 – 1000 Hz; | 6 – 6300 Hz; |
| 3 – 1600 Hz; | 7 – 10000 Hz. |
| 4 – 2500 Hz; | |

Conditions: $V_D=0,67\cdot V_{DRM}$; $V_R=0,67\cdot V_{RRM}$.

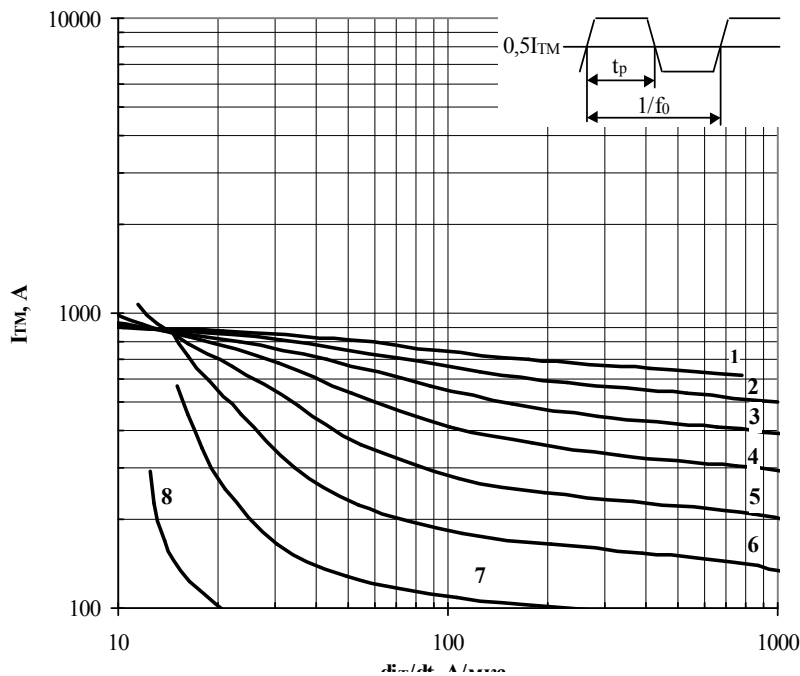

Fig. 10 Maximum allowable mean on-state current I_{TM} of trapeze current waveform vs. mean on-state current di_T/dt , pulse duration $t_p=1/2f_0$ and case temperature $T_c=65\text{ }^\circ\text{C}$.

- | | |
|--------------|---------------|
| 1 – 630 Hz; | 5 – 4000 Hz; |
| 2 – 1000 Hz; | 6 – 6300 Hz; |
| 3 – 1600 Hz; | 7 – 10000 Hz; |
| 4 – 2500 Hz; | 8 – 16000 Hz |

Conditions: $V_D=0,67\cdot V_{DRM}$; $V_R=0,67\cdot V_{RRM}$

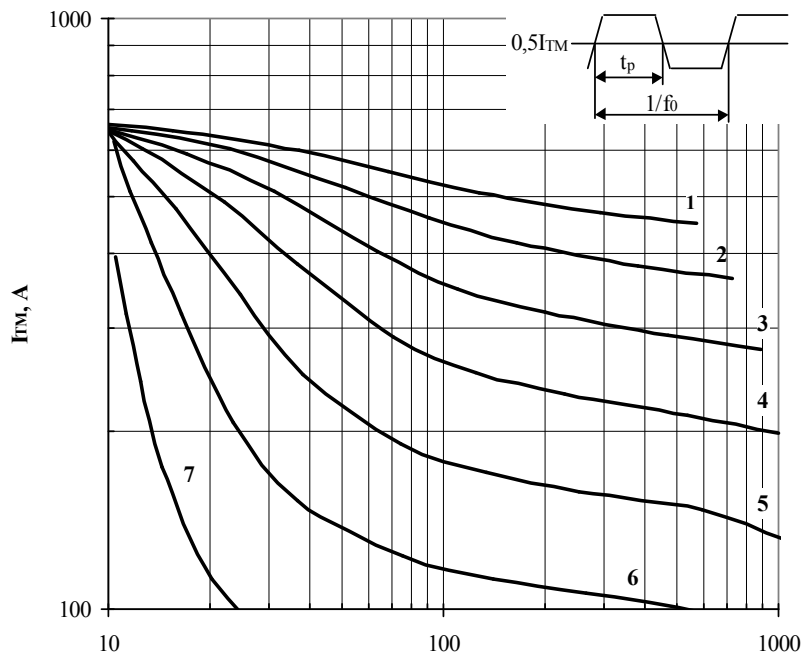

Fig. 11 Maximum allowable mean on-state current I_{TM} of trapeze current waveform vs. on-state current rise rate di_T/dt for pulse duration $t_p=1/2f_0$ and case temperature $T_c=85\text{ }^\circ\text{C}$ at high frequency.

- | | |
|--------------|---------------|
| 1 – 630 Hz; | 5 – 4000 Hz; |
| 2 – 1000 Hz; | 6 – 6300 Hz; |
| 3 – 1600 Hz; | 7 – 10000 Hz. |
| 4 – 2500 Hz; | |

Conditions: $V_D=0,67\cdot V_{DRM}$; $V_{CR}=0,67\cdot V_{RRM}$

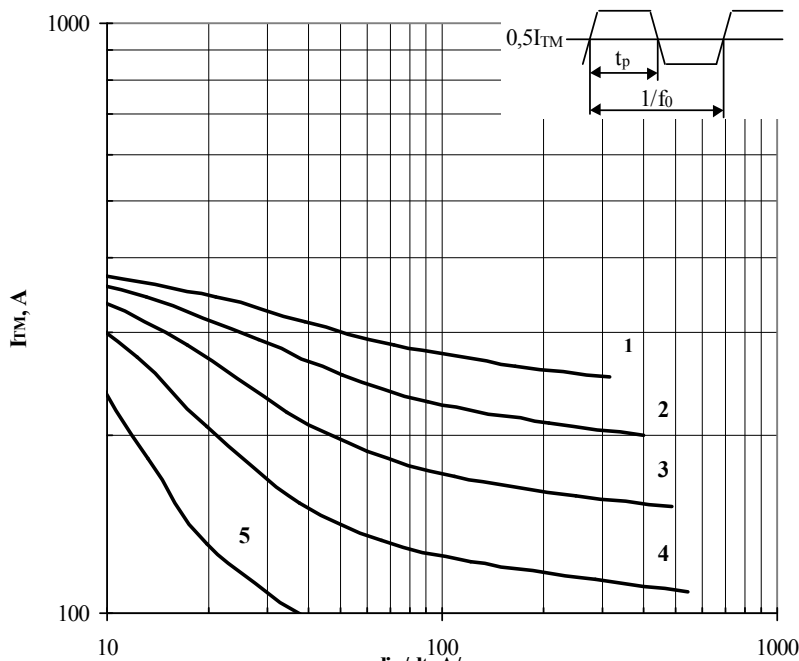

Fig. 12 Maximum allowable mean on-state current I_{TM} of trapeze current waveform vs. on-state current rise rate di_T/dt for pulse duration $t_p=1/2f_0$ and case temperature $T_c=105\text{ }^\circ\text{C}$ at high frequency.

- | | |
|--------------|--------------|
| 1 – 630 Hz; | 4 – 2500 Hz; |
| 2 – 1000 Hz; | 5 – 4000 Hz. |
| 3 – 1600 Hz; | |

Conditions: $V_D=0,67\cdot V_{DRM}$; $V_R=0,67\cdot V_{RRM}$

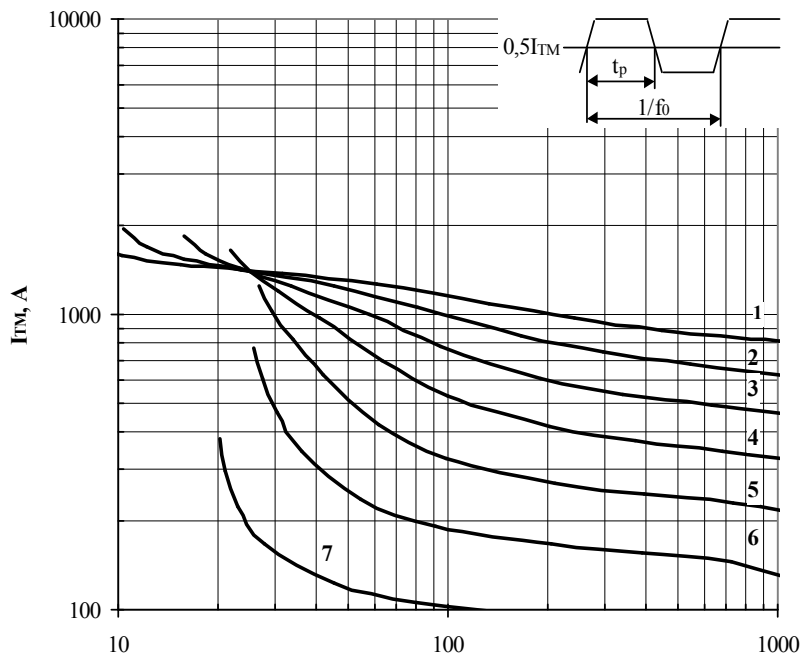

Fig. 13 Maximum allowable mean on-state current I_{TM} of trapeze current waveform vs. on-state current rise rate di_T/dt for pulse duration $t_p=1/4f_0$ and case temperature $T_c=65\text{ }^\circ\text{C}$ at high frequency.

- | | |
|--------------|---------------|
| 1 – 630 Hz; | 5 – 4000 Hz; |
| 2 – 1000 Hz; | 6 – 6300 Hz; |
| 3 – 1600 Hz; | 7 – 10000 Hz. |
| 4 – 2500 Hz; | |

Conditions: $V_D=0,67\cdot V_{DRM}$; $V_R=0,67\cdot V_{RRM}$

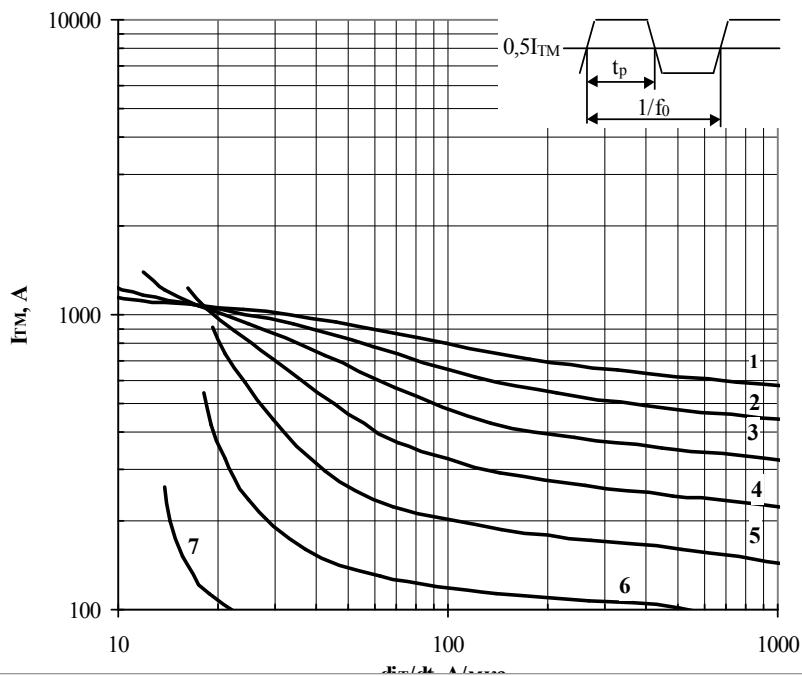

Fig. 14 Maximum allowable mean on-state current I_{TM} of trapeze current waveform vs. on-state current rise rate di_T/dt for pulse duration $t_p=1/4f_0$ and case temperature $T_c=85\text{ }^\circ\text{C}$ at high frequency.

- | | |
|--------------|---------------|
| 1 – 630 Hz; | 5 – 4000 Hz; |
| 2 – 1000 Hz; | 6 – 6300 Hz; |
| 3 – 1600 Hz; | 7 – 10000 Hz. |
| 4 – 2500 Hz; | |

Conditions: $V_D=0,67\cdot V_{DRM}$; $V_R=0,67\cdot V_{RRM}$

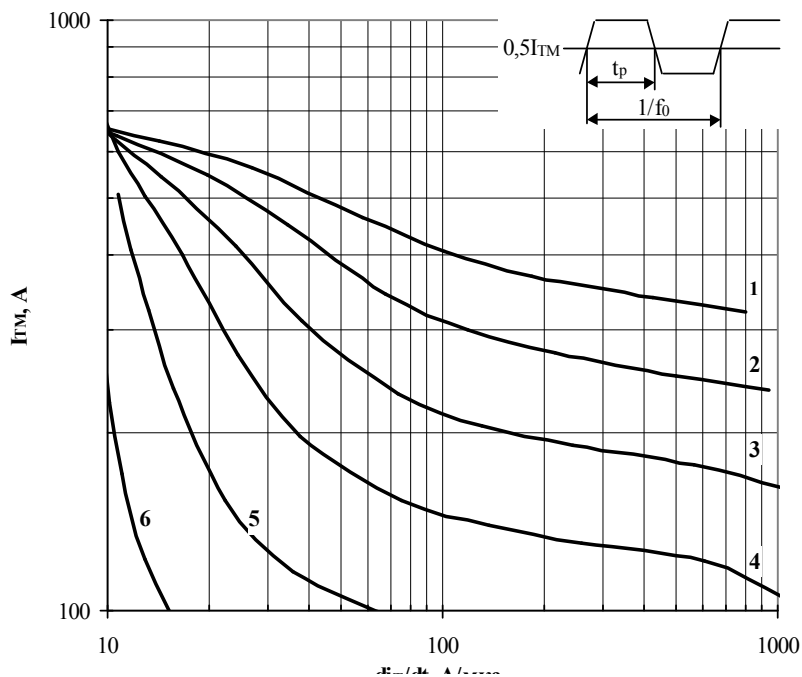

Fig. 15 Maximum allowable mean on-state current I_{TM} of trapeze current waveform vs. on-state current rise rate di_T/dt for pulse duration $t_p=1/4f_0$ and case temperature $T_c=105\text{ °C}$ at high frequency.

- | | |
|--------------|--------------|
| 1 – 630 Hz; | 4 – 2500 Hz; |
| 2 – 1000 Hz; | 5 – 4000 Hz; |
| 3 – 1600 Hz; | 6 – 6300 Hz. |

Conditions: $V_D=0,67\cdot V_{DRM}$; $V_R=0,67\cdot V_{RRM}$

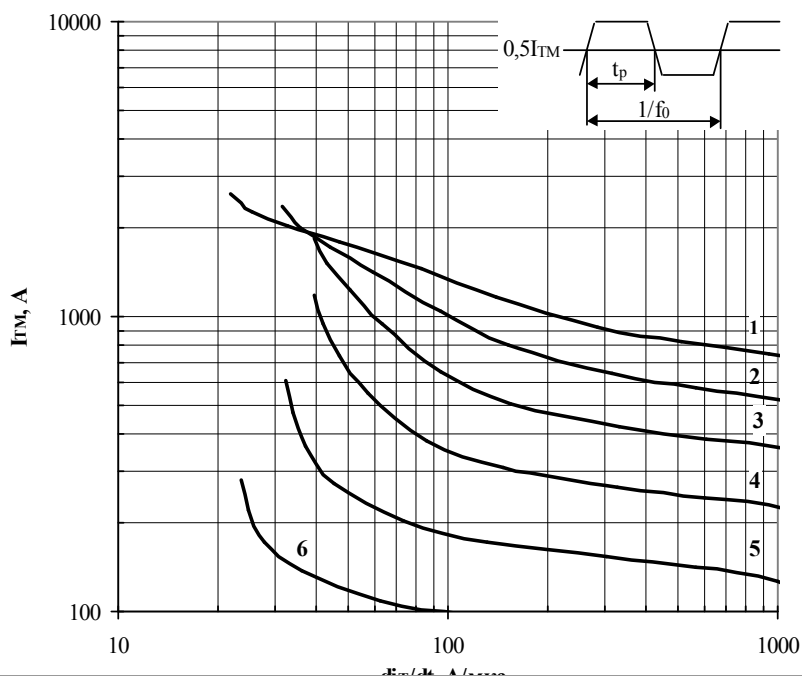

Fig. 16 Maximum allowable mean on-state current I_{TM} of trapeze current waveform vs. on-state current rise rate di_T/dt for pulse duration $t_p=1/10f_0$ and case temperature $T_c=85\text{ °C}$ at high frequency.

- | | |
|--------------|--------------|
| 1 – 630 Hz; | 4 – 2500 Hz; |
| 2 – 1000 Hz; | 5 – 4000 Hz; |
| 3 – 1600 Hz; | 6 – 6300 Hz. |

Conditions: $V_D=0,67\cdot V_{DRM}$; $V_R=0,67\cdot V_{RRM}$

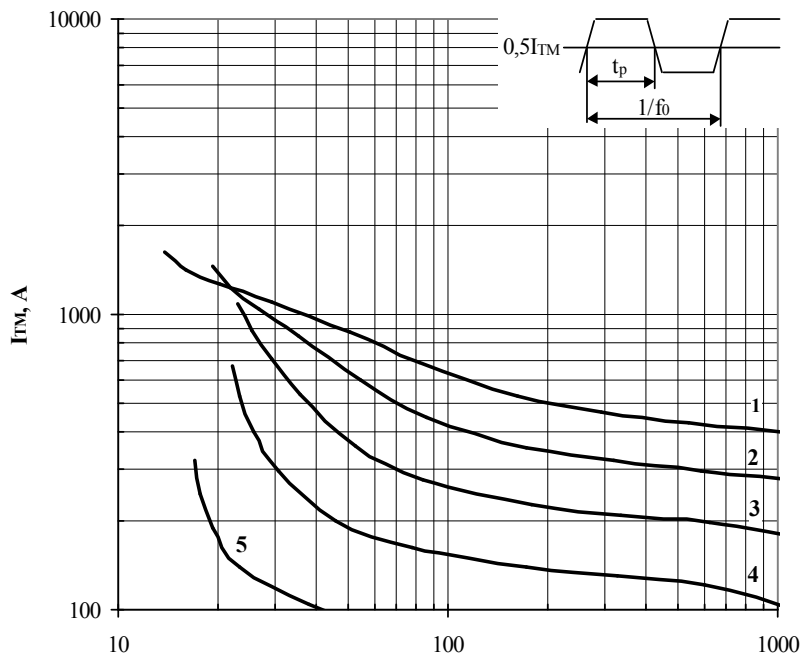

Fig. 17 Maximum allowable mean on-state current I_{TM} of trapeze current waveform vs. on-state current rise rate di_T/dt for pulse duration $t_p=1/10f_0$ and case temperature $T_c=105\text{ °C}$ at high frequency.

- | | |
|--------------|--------------|
| 1 – 630 Hz; | 4 – 2500 Hz; |
| 2 – 1000 Hz; | 5 – 4000 Hz. |
| 3 – 1600 Hz; | |

Conditions: $V_D=0,67\cdot V_{DRM}$; $V_R=0,67\cdot V_{RRM}$

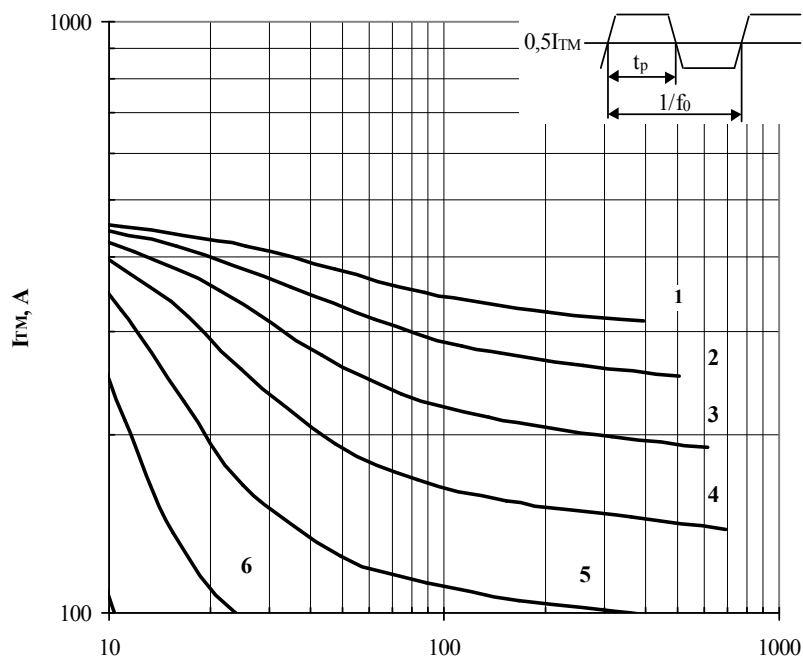

Fig.18 Maximum allowable mean on-state current I_{TAV} of trapeze current waveform vs. on-state current rise rate di_T/dt for pulse duration $t_p=1/2f_0$, cooling temperature $T_a=40\text{ °C}$, cooling air force 6 m/s, heat sink 0143 at high frequency.

- | | |
|--------------|--------------|
| 1 – 630 Hz; | 4 – 2500 Hz; |
| 2 – 1000 Hz; | 5 – 4000 Hz; |
| 3 – 1600 Hz; | 6 – 6300 Hz. |

Conditions: $V_D=0,67\cdot V_{DRM}$; $V_R=0,67\cdot V_{RRM}$

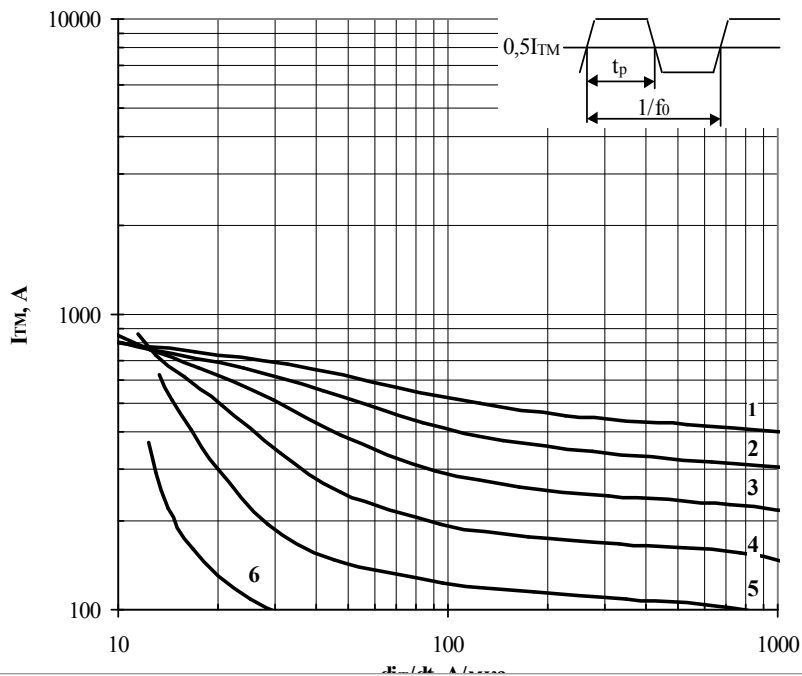

Fig. 19 Maximum allowable mean on-state current I_{TAV} of trapeze current waveform vs. on-state current rise rate di_T/dt for pulse duration $t_p=1/4f_0$, cooling temperature $T_a=40\text{ }^\circ\text{C}$, cooling air force 6 m/s, heatsink 0143 at high frequency.

- | | |
|--------------|--------------|
| 1 – 630 Hz; | 4 – 2500 Hz; |
| 2 – 1000 Hz; | 5 – 4000 Hz; |
| 3 – 1600 Hz; | 6 – 6300 Hz. |

Conditions: $V_D=0,67\cdot V_{DRM}$; $V_R=0,67\cdot V_{RRM}$

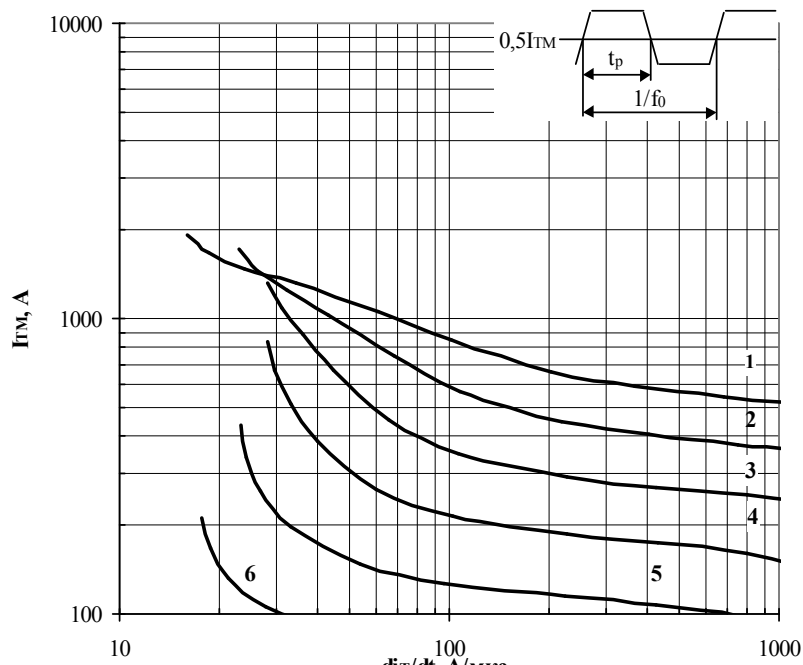

Fig. 20 Maximum allowable mean on-state current I_{TAV} of trapeze current waveform vs. on-state current rise rate di_T/dt for pulse duration $t_p=1/10f_0$, cooling temperature $T_a=40\text{ }^\circ\text{C}$, cooling air force 6 m/s, heatsink 0143 at high frequency.

- | | |
|--------------|--------------|
| 1 – 630 Hz; | 4 – 2500 Hz; |
| 2 – 1000 Hz; | 5 – 4000 Hz; |
| 3 – 1600 Hz; | 6 – 6300 Hz. |

Conditions: $V_D=0,67\cdot V_{DRM}$; $V_R=0,67\cdot V_{RRM}$

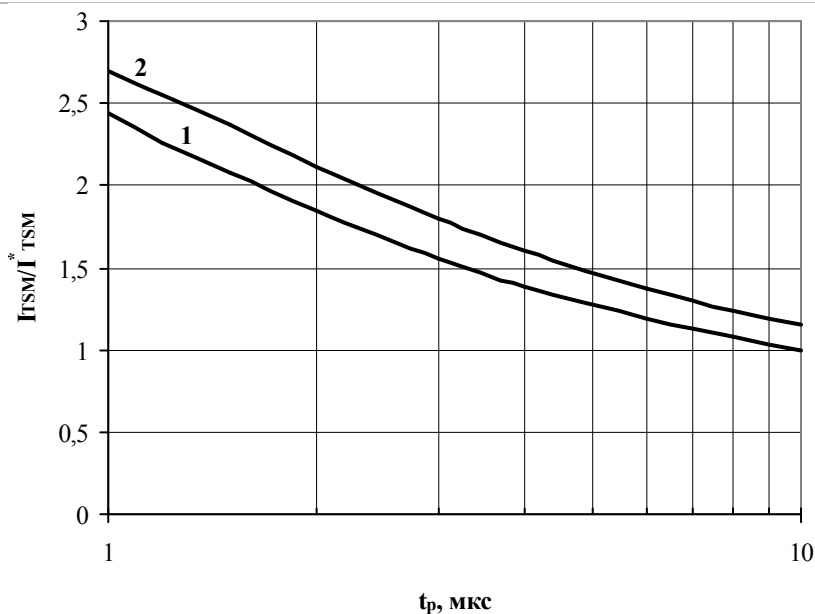

Fig. 21 Maximum allowable surge on-state current I_{TM} vs. pulse duration t_p .
 1 – $T_j=125\text{ °C}$
 2 – $T_j=25\text{ °C}$

Conditions: $V_R=0$.

Typical changes are normalized to I_{TSM}^* – maximum allowable surge on-state current for $t_p = 10\text{ ms}$, $V_R = 0$, junction temperature 125 °C .

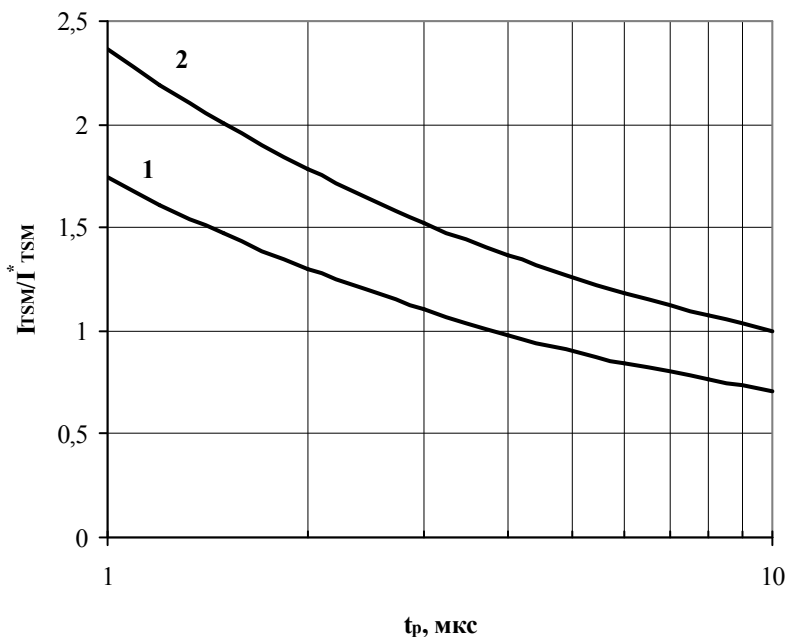

Fig. 22 Maximum allowable surge on-state current I_{TM} vs. pulse duration t_p for initial junction temperature:
 1 – $T_j=125\text{ °C}$
 2 – $T_j=25\text{ °C}$

Conditions: $V_R=0,8 \cdot V_{RRM}$

Typical changes are normalized to I_{TSM}^* – maximum allowable surge on-state current for $t_p = 10\text{ ms}$, $V_R = 0$, junction temperature 125 °C .

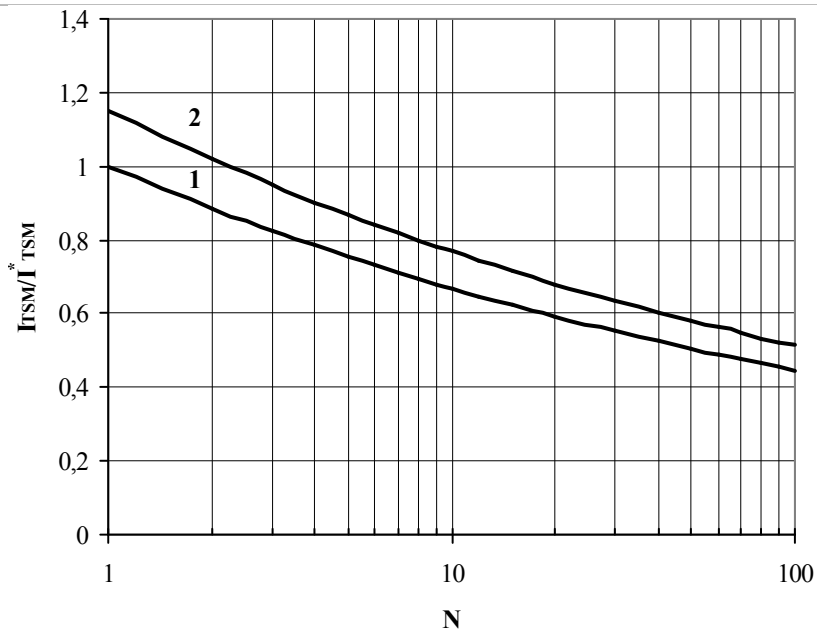

Fig. 23 Maximum allowable surge on-state current I_{TM} vs. pulse quantity of overload current N
 1 – $T_j=125\text{ }^\circ\text{C}$
 2 – $T_j=25\text{ }^\circ\text{C}$

Conditions: sinusoidal pulse waveform, duration $t_p = 10\text{ ms}$, $f = 50\text{ Hz}$, on-off time ratio $V_R=0$.
 Typical changes are normalized to I_{TSM}^* – maximum allowable single pulse surge on-state current for $t_p = 10\text{ ms}$, $V_R = 0$, junction temperature $125\text{ }^\circ\text{C}$.

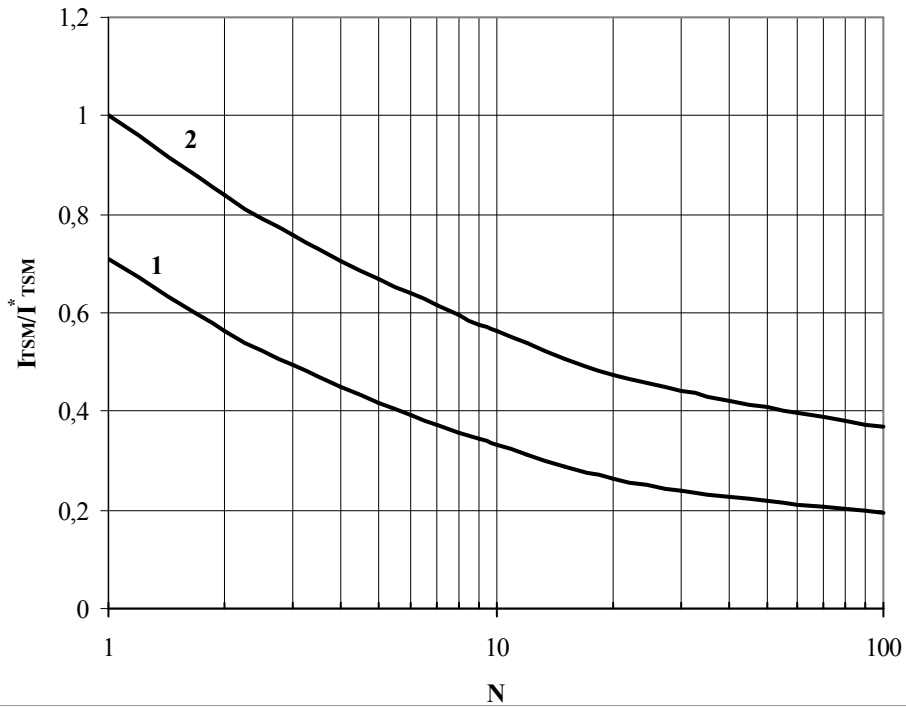
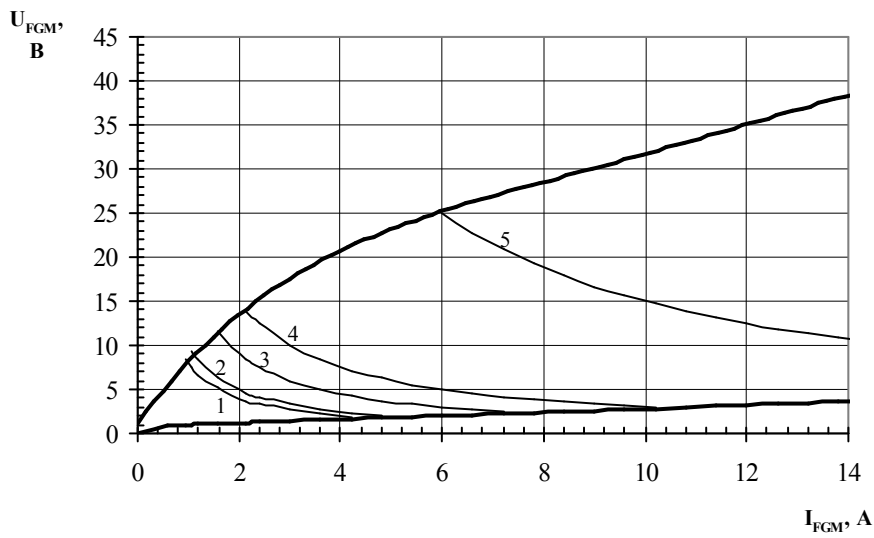

Fig. 24 Maximum allowable surge on-state current I_{TM} vs. pulse quantity of overload current N.
 1 – $T_j=125\text{ }^\circ\text{C}$
 2 – $T_j=25\text{ }^\circ\text{C}$

Conditions: sinusoidal pulse waveform, duration $t_p = 10\text{ ms}$, $f = 50\text{ Hz}$, on-off time ratio 2, $V_R=0,8 \cdot V_{RRM}$.

Typical changes are normalized to I_{TSM}^* – maximum allowable surge on-state current for $t_p = 10\text{ ms}$, $V_R = 0$, junction temperature $125\text{ }^\circ\text{C}$.



Position	On-Off time ratio	Gate pulse length, ms	Gate Pulse Power, W
1	1	DC	8
2	2	10	10
3	20	1	18
4	40	0,5	30
5	200	0,1	150

Fig. 25 Gate characteristics.

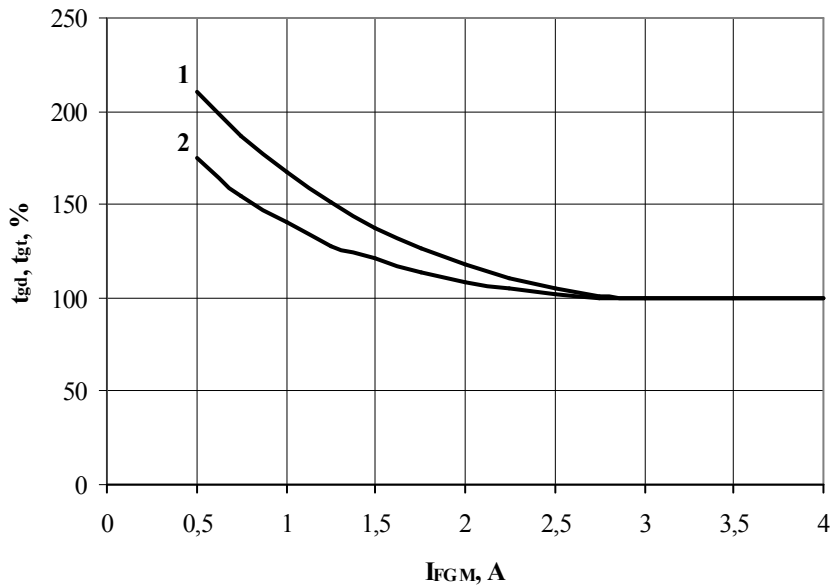

Fig. 26 Delay time t_{gd} (1) and turn-off time t_{gt} (2) vs. gate puls current I_{FGM}

Conditions: $T_j=25\text{ }^\circ\text{C}$, $V_D=500\text{ V}$, $di_G/dt=1\text{ A}/\mu\text{s}$, $t_G=10\text{ }\mu\text{s}$, $I_T=I_{TAV}$.

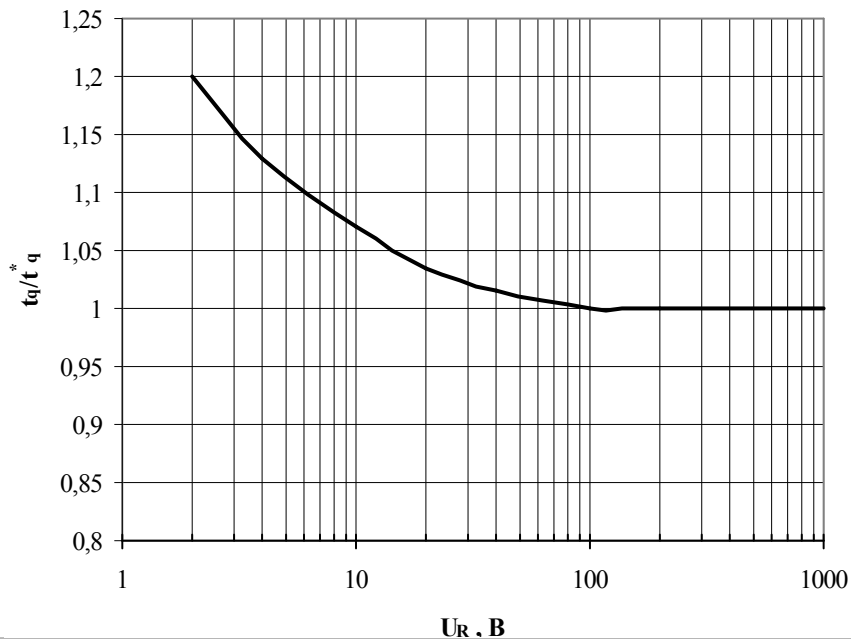

Fig. 27 Turn-on time t_q vs. reverse voltage V_R .

Conditions: $T_j=125\text{ }^\circ\text{C}$, $I_T=I_{TAV}$, $(di_T/dt)_f=10\text{ A}/\mu\text{s}$, $dU_D/dt=50\text{ V}/\mu\text{s}$, $V_D=0,67\cdot V_{DRM}$.

Typical changes are normalized to the turn-off time t_q^* for $T_j = 125\text{ }^\circ\text{C}$, $I_T=I_{TAV}$, $(di_T/dt)_f=10\text{A}/\mu\text{s}$, $V_R=100\text{ V}$, $dV_D/dt=50\text{ v}/\mu\text{s}$, $V_D=0,67\cdot V_{DRM}$

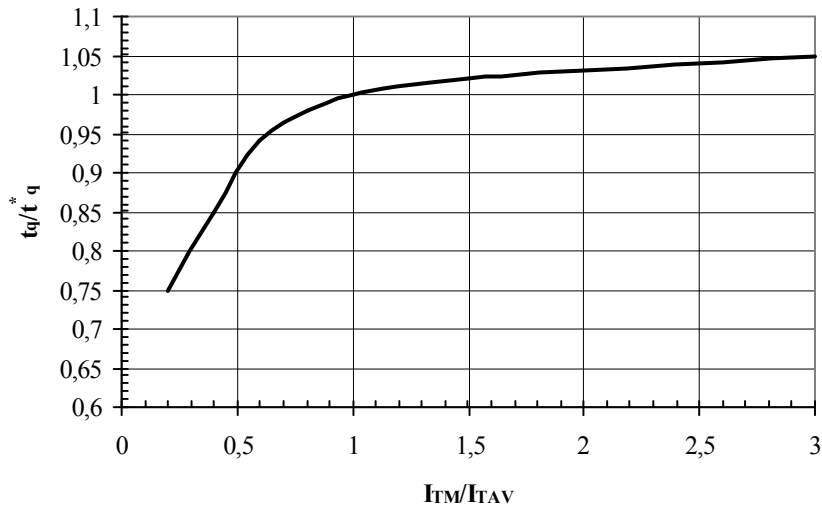

Fig. 28 Turn-off time t_q vs. mean on-state current I_T/I_{TAV} .

Conditions: $T_j=125\text{ }^\circ\text{C}$, $(di_T/dt)_f=10\text{A}/\mu\text{s}$, $V_R=100\text{ B}$, $dV_D/dt=50\text{ V}/\mu\text{s}$, $V_D=0,67\cdot V_{DRM}$.

Typical changes are normalized to the turn-off time t_q^* for $T_j = 125\text{ }^\circ\text{C}$, $I_T=I_{TAV}$, $(di_T/dt)_f=10\text{A}/\mu\text{s}$, $V_R=100\text{ V}$, $dV_D/dt=50\text{ v}/\mu\text{s}$, $V_D=0,67\cdot V_{DRM}$

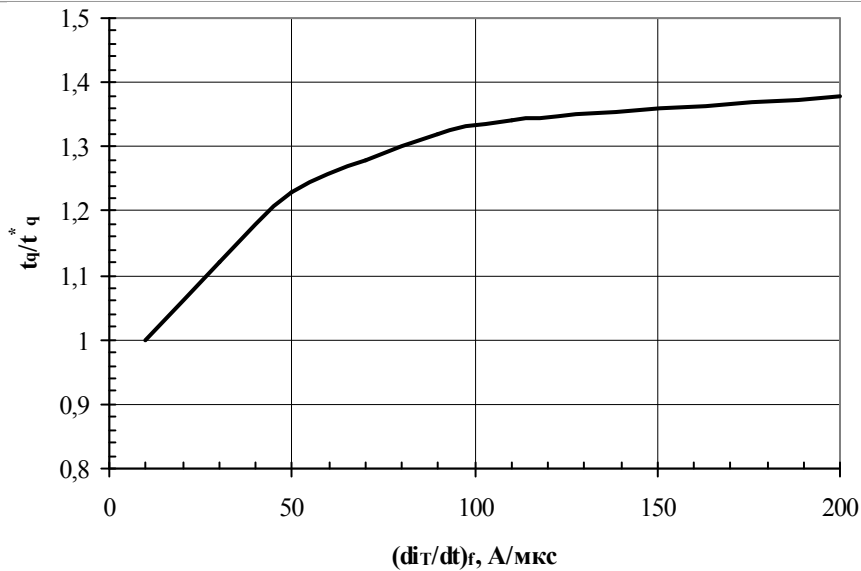

Fig. 29 Turn-on time t_q vs. rate of fall of on-state current $(di_T/dt)_f$.

Conditions: $T_j=125\text{ }^\circ\text{C}$, $I_T=I_{TAV}$, $V_R=100\text{ V}$, $dV_D/dt=50\text{ V}/\mu\text{s}$, $U_D=0,67\cdot U_{DRM}$.

Typical changes are normalized to the turn-off time t_q^* for $T_j = 125\text{ }^\circ\text{C}$, $I_T=I_{TAV}$, $(di_T/dt)_f=10\text{ A}/\mu\text{s}$, $V_R=100\text{ V}$, $dV_D/dt=50\text{ V}/\mu\text{s}$, $V_D=0,67\cdot V_{DRM}$.

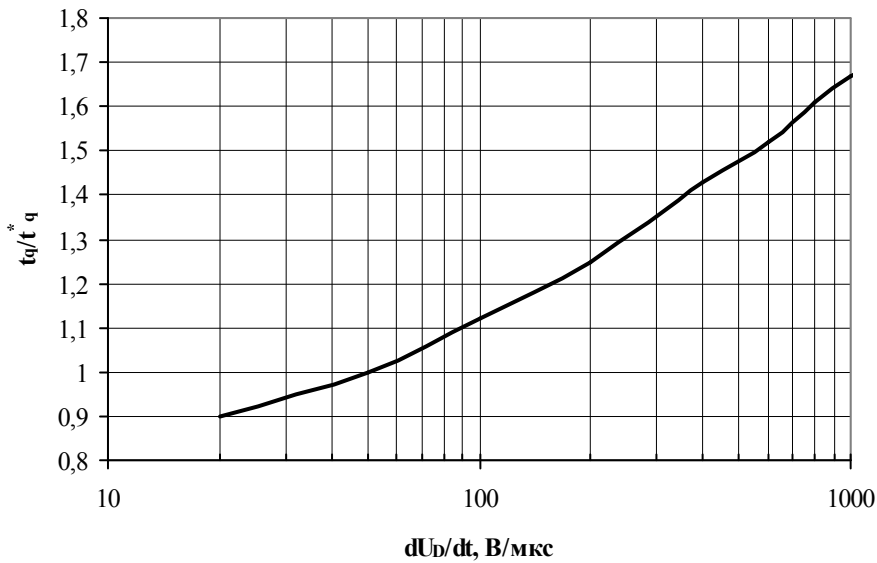

Fig. 30 Turn-on time t_q vs. rate of rise of off-state voltage $(di_T/dt)_f$.

Conditions: $T_j=125\text{ }^\circ\text{C}$, $I_T=I_{TAV}$, $(di_T/dt)_f=10\text{ A}/\mu\text{s}$, $V_R=100\text{ V}$, $V_D=0,67\cdot V_{DRM}$.

Typical changes are normalized to the turn-off time t_q^* for $T_j = 125\text{ }^\circ\text{C}$, $I_T=I_{TAV}$, $(di_T/dt)_f=10\text{ A}/\mu\text{s}$, $V_R=100\text{ V}$, $dV_D/dt=50\text{ V}/\mu\text{s}$, $V_D=0,67\cdot V_{DRM}$.

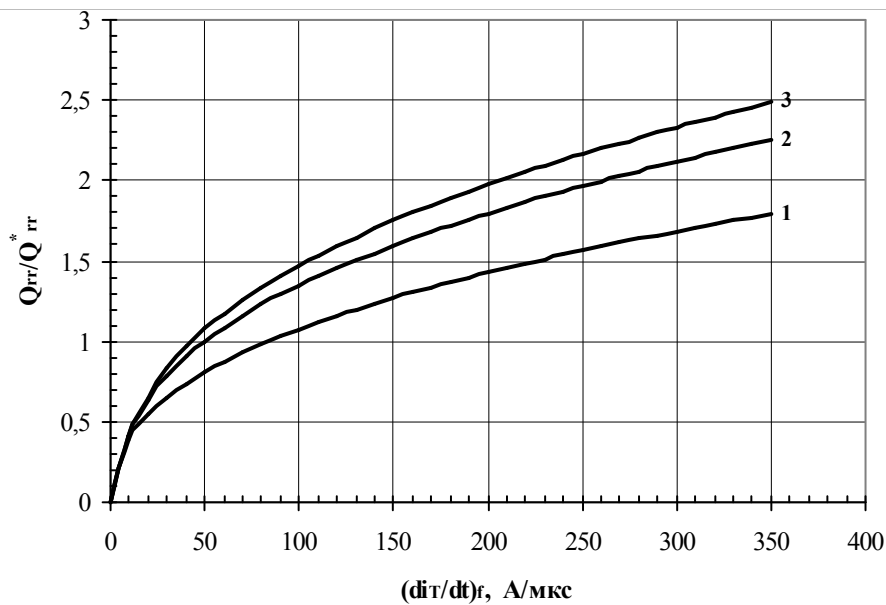

Fig. 31 Reverse recovery charge Q_{rr} vs. rate of fall of on-state current $(di_T/dt)_f$.

- 1 - $I_T = 0,5 I_{TAV}$;
- 2 - $I_T = I_{TAV}$;
- 3 - $I_T = 1,5 I_{TAV}$.

Conditions: $T_j = 125\text{ }^\circ\text{C}$, $V_R = 100\text{ V}$.

Typical changes are normalized to the reverse recovery charge Q_{rr}^* for $T_j = 125\text{ }^\circ\text{C}$, $I_T = I_{TAV}$, $(di_T/dt)_f = 50\text{ A}/\mu\text{s}$, $V_R = 100\text{ V}$.

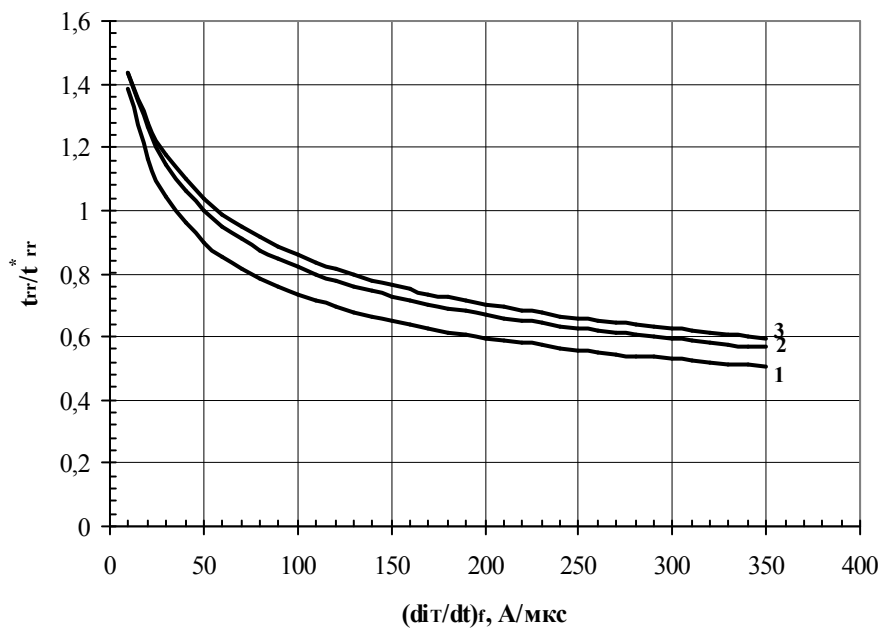

Fig. 32 Typical reverse recovery charge t_{rr} vs. rate of fall of on-state current $(di_T/dt)_f$.

- 1 - $I_T = 0,5 I_{TAV}$;
- 2 - $I_T = I_{TAV}$;
- 3 - $I_T = 1,5 I_{TAV}$.

Conditions: $T_j = 125\text{ }^\circ\text{C}$, $V_R = 100\text{ V}$.

Typical changes are normalized to the reverse recovery charge t_{rr}^* for $T_j = 125\text{ }^\circ\text{C}$, $I_T = I_{TAV}$, $(di_T/dt)_f = 50\text{ A}/\mu\text{s}$, $V_R = 100\text{ V}$.

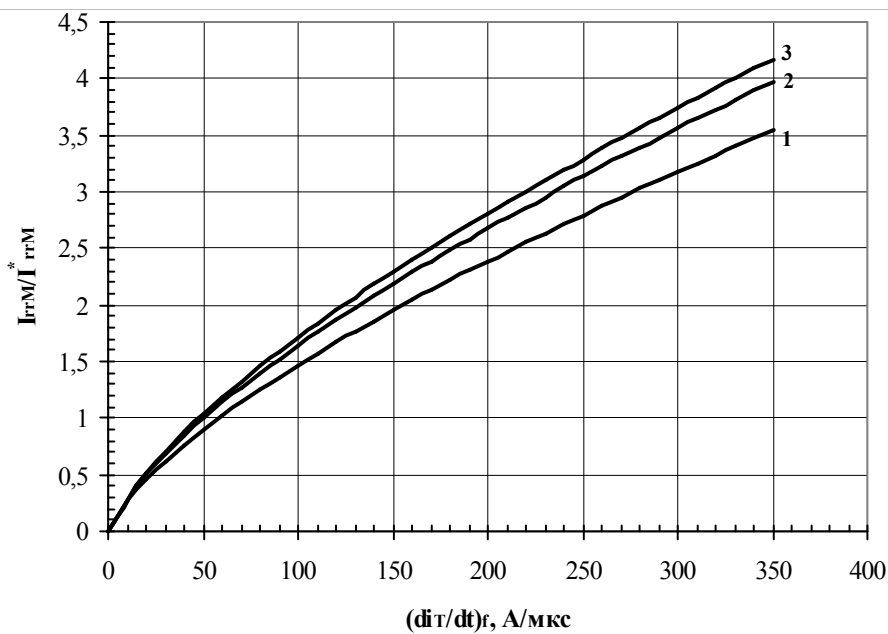

Fig. 33 Typical reverse recovery current I_{rrM} vs. rate of fall of on-state current $(di_T/dt)_f$.

1 - $I_T = 0,5 I_{TAV}$;

2 - $I_T = I_{TAV}$;

3 - $I_T = 1,5 I_{TAV}$.

Conditions: $T_j = 125^\circ\text{C}$, $V_R = 100\text{ V}$.

Typical changes are normalized to the reverse recovery current I_{rrM} for $T_j = 125^\circ\text{C}$, $I_T = I_{TAV}$, $(di_T/dt)_f = 50\text{ A}/\mu\text{s}$, $V_R = 100\text{ V}$.

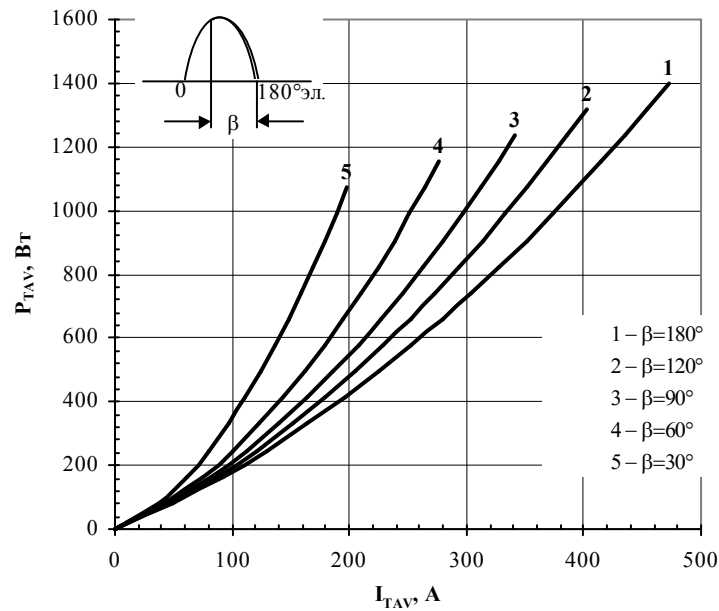

Fig. 34 Mean on-state power dissipation P_{TAV} vs. mean on-state current for sinusoidal current waveforms at different conduction angles, $f = 50\text{ Hz}$

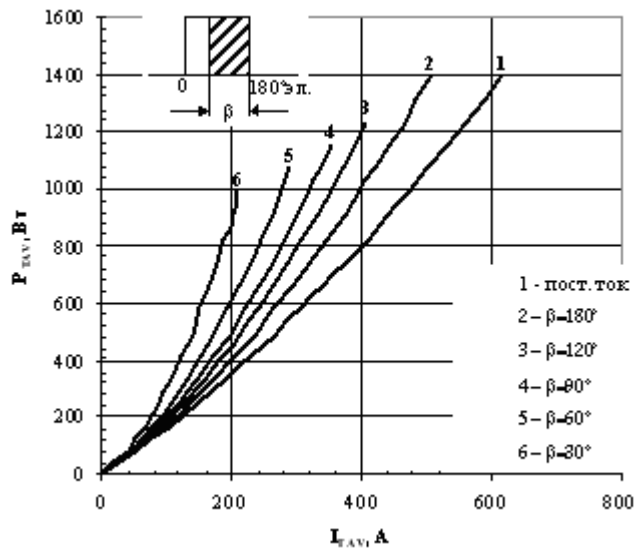

Fig. 35 Mean on-state power dissipation P_{TAV} vs. mean on-state current for rectangular current waveforms at different conduction angles, $f=50\text{Hz}$ and DC.

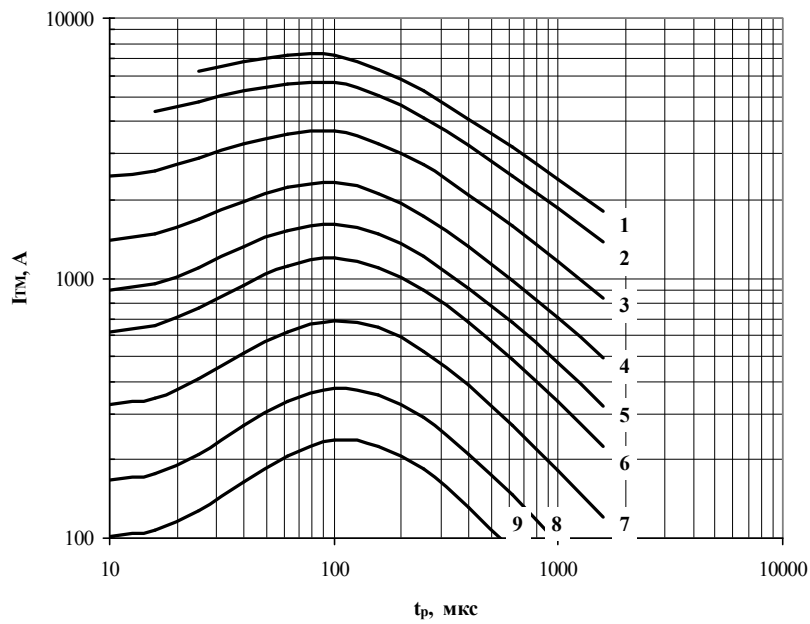

Fig. 36 Total power loss of one sinusoidal on-state current pulse vs. pulse duration t_p and current I_{TM}

Total power loss:

- 1 - 6 G;
- 2 - 4 G;
- 3 - 2 G;
- 4 - 1 G;
- 5 - 0,6 G;
- 6 - 0,4 G;
- 7 - 0,2 G;
- 8 - 0,1 G;
- 9 - 0,06 G.

Conditions: $V_D=0,67 \cdot V_{DRM}$; $V_R=0,67 \cdot V_{RRM}$.

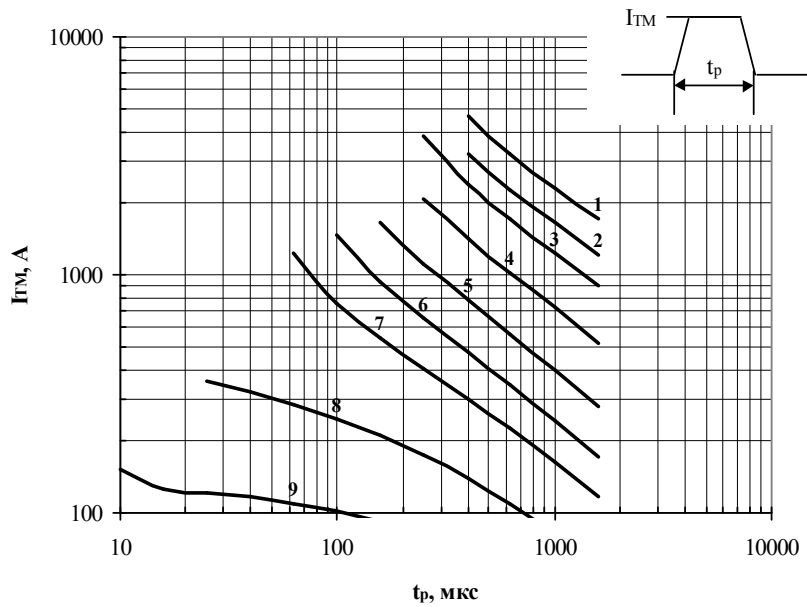

Fig. 37 Total power loss of one trapeze on-state current pulse vs. pulse duration t_p and current I_{TM}

Total power loss:

- 1 – 10 G;
- 2 – 6 G;
- 3 – 4 G;
- 4 – 2 G;
- 5 – 1 G;
- 6 – 0,6 G;
- 7 – 0,4 G;
- 8 – 0,2 G;
- 9 – 0,1 G.

Conditions: $di_T/dt = 50 \text{ A}/\mu\text{s}$; $V_D = 0,67 \cdot V_{DRM}$; $V_R = 0,67 \cdot V_{RRM}$.

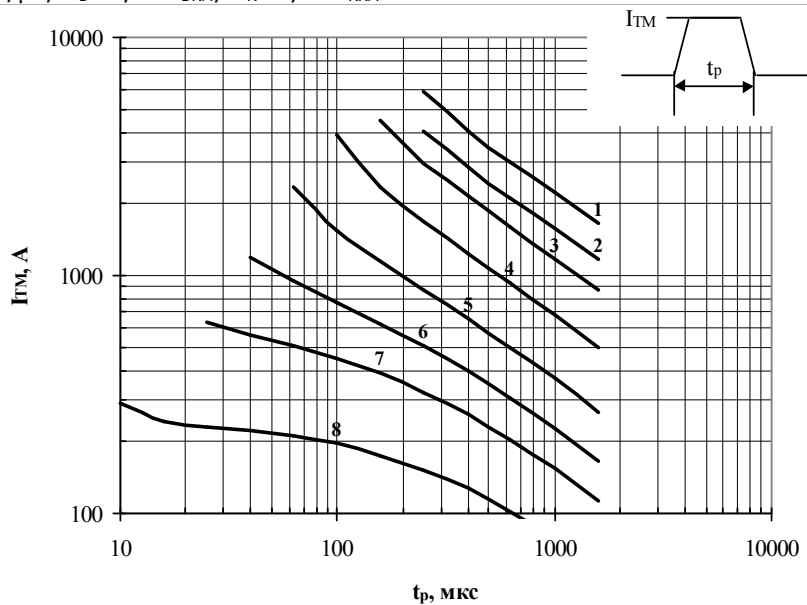

Fig. 38

Total power loss of one trapeze on-state current pulse vs. pulse duration t_p and current I_{TM}

Total power loss:

- 1 – 10 G;
- 2 – 6 G;
- 3 – 4 G;
- 4 – 2 G;
- 5 – 1 G;
- 6 – 0,6 G;
- 7 – 0,4 G;
- 8 – 0,2 G.

Conditions: $di_T/dt = 100 \text{ A}/\mu\text{s}$; $V_D = 0,67 \cdot V_{DRM}$; $V_R = 0,67 \cdot V_{RRM}$.

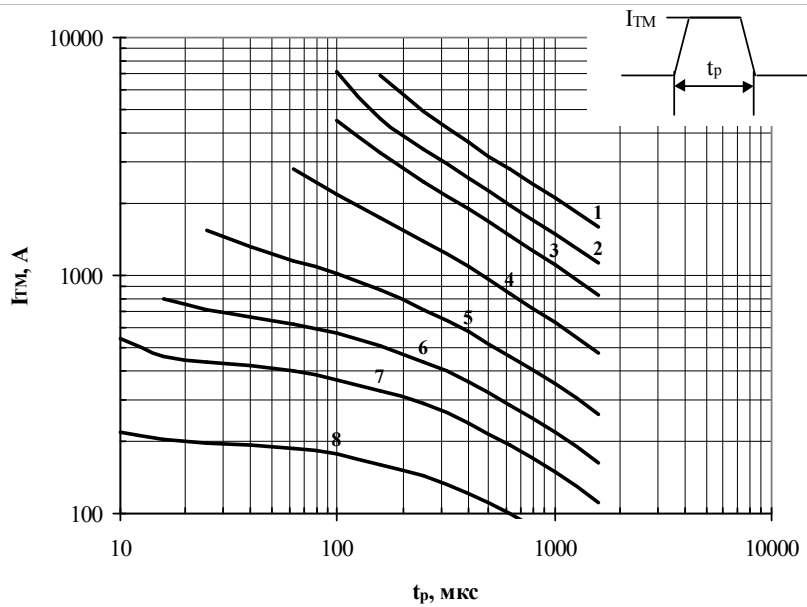

Fig. 39 Total power loss of one trapeze on-state current pulse vs. pulse duration t_p and current I_{TM}

Total power loss:

- 1 – 10 G;
- 2 – 6 G;
- 3 – 4 G;
- 4 – 2 G;
- 5 – 1 G;
- 6 – 0,6 G;
- 7 – 0,4 G;
- 8 – 0,2 G.

Conditions: $di_T/dt = 200 \text{ A}/\mu\text{s}$; $V_D = 0,67 \cdot V_{DRM}$; $V_R = 0,67 \cdot V_{RRM}$.