



**Fast Stud Thyristor  
Type TFI371-200-14**

Pressure contact  
Low switching losses  
Low reverse recovery charge  
High power cycling capability  
Distributed amplified gate for high  $di_T/dt$

Mean on-state current	$I_{TAV}$		200 A		
Repetitive peak off-state voltage	$V_{DRM}$		1000 ÷ 1400 V		
Repetitive peak reverse voltage	$V_{RRM}$				
Turn-off time	$t_q$		20.0, 25.0, 32.0, 40.0 $\mu s$		
$V_{DRM}, V_{RRM}, V$	1000	1100	1200	1300	1400
Voltage code	10	11	12	13	14
$T_j, ^\circ C$	- 60 ÷ 125				

**MAXIMUM ALLOWABLE RATINGS**

Symbols and parameters		Units	Values	Test conditions
<b>ON-STATE</b>				
$I_{TAV}$	Mean on-state current	A	200 375	$T_c=95^\circ C$ ; $T_c=55^\circ C$ ; 180° half-sine wave; 50 Hz
$I_{TRMS}$	RMS on-state current	A	314	$T_c=95^\circ C$ ; 180° half-sine wave; 50 Hz
$I_{TSM}$	Surge on-state current	kA	6.0 6.9	$T_j=T_{jmax}$ $T_j=25^\circ C$ 180° half-sine wave; $t_p=10$ ms; single pulse; $V_D=V_R=0$ V; Gate pulse: $I_G=I_{FGM}$ ; $V_G=20$ V; $t_{GP}=50$ $\mu s$ ; $di_G/dt=1$ A/ $\mu s$
			6.5 7.5	$T_j=T_{jmax}$ $T_j=25^\circ C$ 180° half-sine wave; $t_p=8.3$ ms; single pulse; $V_D=V_R=0$ V; Gate pulse: $I_G=I_{FGM}$ ; $V_G=20$ V; $t_{GP}=50$ $\mu s$ ; $di_G/dt=1$ A/ $\mu s$
$I^2t$	Safety factor	$A^2s \cdot 10^3$	180 230	$T_j=T_{jmax}$ $T_j=25^\circ C$ 180° half-sine wave; $t_p=10$ ms; single pulse; $V_D=V_R=0$ V; Gate pulse: $I_G=I_{FGM}$ ; $V_G=20$ V; $t_{GP}=50$ $\mu s$ ; $di_G/dt=1$ A/ $\mu s$
			170 230	$T_j=T_{jmax}$ $T_j=25^\circ C$ 180° half-sine wave; $t_p=8.3$ ms; single pulse; $V_D=V_R=0$ V; Gate pulse: $I_G=I_{FGM}$ ; $V_G=20$ V; $t_{GP}=50$ $\mu s$ ; $di_G/dt=1$ A/ $\mu s$
<b>BLOCKING</b>				
$V_{DRM}, V_{RRM}$	Repetitive peak off-state and Repetitive peak reverse voltages	V	1000÷1400	$T_{jmin} < T_j < T_{jmax}$ ; 180° half-sine wave; 50 Hz; Gate open
$V_{DSM}, V_{RSM}$	Non-repetitive peak off-state and Non-repetitive peak reverse voltages	V	1100÷1500	$T_{jmin} < T_j < T_{jmax}$ ; 180° half-sine wave; single pulse; Gate open
$V_D, V_R$	Direct off-state and Direct reverse voltages	V	0.6· $V_{DRM}$ 0.6· $V_{RRM}$	$T_j=T_{jmax}$ ; Gate open

<b>TRIGGERING</b>				
$I_{FGM}$	Peak forward gate current	A	6	$T_j = T_{j\max}$
$V_{RGM}$	Peak reverse gate voltage	V	5	
$P_G$	Gate power dissipation	W	3	$T_j = T_{j\max}$ for DC gate current
<b>SWITCHING</b>				
$(di_T/dt)_{crit}$	Critical rate of rise of on-state current non-repetitive (f=1 Hz)	A/ $\mu$ s	1600	$T_j = T_{j\max}$ ; $V_D = 0.67 \cdot V_{DRM}$ ; $I_{TM} = 2 I_{TAV}$ ; Gate pulse: $I_G = 2$ A; $V_G = 20$ V; $t_{GP} = 50$ $\mu$ s; $di_G/dt = 2$ A/ $\mu$ s
<b>THERMAL</b>				
$T_{stg}$	Storage temperature	$^{\circ}$ C	-60 ÷ 50	
$T_j$	Operating junction temperature	$^{\circ}$ C	-60 ÷ 125	
<b>MECHANICAL</b>				
M	Tightening torque	Nm	25 ÷ 35	
a	Acceleration	m/s <sup>2</sup>	100	

## CHARACTERISTICS

Symbols and parameters		Units	Values	Conditions	
<b>ON-STATE</b>					
$V_{TM}$	Peak on-state voltage, max	V	1.96	$T_j = 25$ $^{\circ}$ C; $I_{TM} = 628$ A	
$V_{T(TO)}$	On-state threshold voltage, max	V	1.31	$T_j = T_{j\max}$ ;	
$r_T$	On-state slope resistance, max	m $\Omega$	1.100	$0.5 \pi I_{TAV} < I_T < 1.5 \pi I_{TAV}$	
$I_H$	Holding current, max	mA	500	$T_j = 25$ $^{\circ}$ C; $V_D = 12$ V; Gate open	
<b>BLOCKING</b>					
$I_{DRM}, I_{RRM}$	Repetitive peak off-state and Repetitive peak reverse currents, max	mA	70	$T_j = T_{j\max}$ ; $V_D = V_{DRM}$ ; $V_R = V_{RRM}$	
$(dv_D/dt)_{crit}$	Critical rate of rise of off-state voltage <sup>1)</sup> , min	V/ $\mu$ s	200, 320, 500, 1000	$T_j = T_{j\max}$ ; $V_D = 0.67 \cdot V_{DRM}$ ; Gate open	
<b>TRIGGERING</b>					
$V_{GT}$	Gate trigger direct voltage, max	V	4.00	$T_j = T_{j\min}$ $T_j = 25$ $^{\circ}$ C $T_j = T_{j\max}$	Direct gate current
			2.50		
			2.00		
$I_{GT}$	Gate trigger direct current, max	mA	400	$T_j = T_{j\min}$ $T_j = 25$ $^{\circ}$ C $T_j = T_{j\max}$	Direct gate current
			250		
			200		
$V_{GD}$	Gate non-trigger direct voltage, min	V	0.45	$T_j = T_{j\max}$ ; $V_D = 0.67 \cdot V_{DRM}$ ;	
$I_{GD}$	Gate non-trigger direct current, min	mA	10.00	Direct gate current	
<b>SWITCHING</b>					
$t_{gd}$	Delay time, max	$\mu$ s	0.58	$T_j = 25$ $^{\circ}$ C; $V_D = 600$ V; $I_{TM} = I_{TAV}$ ; $di/dt = 200$ A/ $\mu$ s;	
$t_{gt}$	Turn-on time <sup>2)</sup>	$\mu$ s	1.25, 1.60, 2.00, 2.50	Gate pulse: $I_G = 2$ A; $V_G = 20$ V; $t_{GP} = 50$ $\mu$ s; $di_G/dt = 2$ A/ $\mu$ s	
$t_q$	Turn-off time <sup>3)</sup>	$\mu$ s	20.0, 25.0, 32.0, 40.0	$dv_D/dt = 50$ V/ $\mu$ s; $T_j = T_{j\max}$ ; $I_{TM} = I_{TAV}$ ; $di_R/dt = -10$ A/ $\mu$ s; $V_R = 100$ V; $V_D = 0.67 V_{DRM}$	
$Q_{rr}$	Total recovered charge, max	$\mu$ C	150	$T_j = T_{j\max}$ ; $I_{TM} = I_{TAV}$ ;	
$t_{rr}$	Reverse recovery time, typ	$\mu$ s	3.2	$di_R/dt = -50$ A/ $\mu$ s;	
$I_{rrM}$	Peak reverse recovery current, max	A	94	$V_R = 100$ V	

<b>THERMAL</b>				
$R_{thjc}$	Thermal resistance, junction to case, max	$^{\circ}\text{C}/\text{W}$	0.0800	Direct current
<b>MECHANICAL</b>				
w	Weight, typ	g	470	
$D_s$	Surface creepage distance	mm (inch)	12.4 (4.882)	
$D_a$	Air strike distance	mm (inch)	12.4 (4.882)	

<b>PART NUMBERING GUIDE</b>								<b>NOTES</b>						
TFI	371	200	14	A2	P3	X4	N	1) Critical rate of rise of off-state voltage						
1	2	3	4	5	6	7	8	Symbol of group	P2	K2	E2	A2		
1. High Frequency Inverter Grade Thyristor								$(dv_D/dt)_{crit}$ , V/ $\mu\text{s}$	200	320	500	1000		
2. Design version								2) Turn-on time						
3. Mean on-state current, A								Symbol of group	X4	T4	P4	M4		
4. Voltage code								$t_{gt}$ , $\mu\text{s}$	1.25	1.60	2.00	2.50		
5. Critical rate of rise of off-state voltage								3) Turn-off time ( $dv_D/dt=50$ V/ $\mu\text{s}$ )						
6. Group of turn-off time ( $dv_D/dt=50$ V/ $\mu\text{s}$ )								Symbol of group	P3	M3	K3	H3		
7. Group of turn-on time								$t_q$ , $\mu\text{s}$	20.0	25.0	32.0	40.0		
8. Ambient conditions: N – normal; T – tropica														

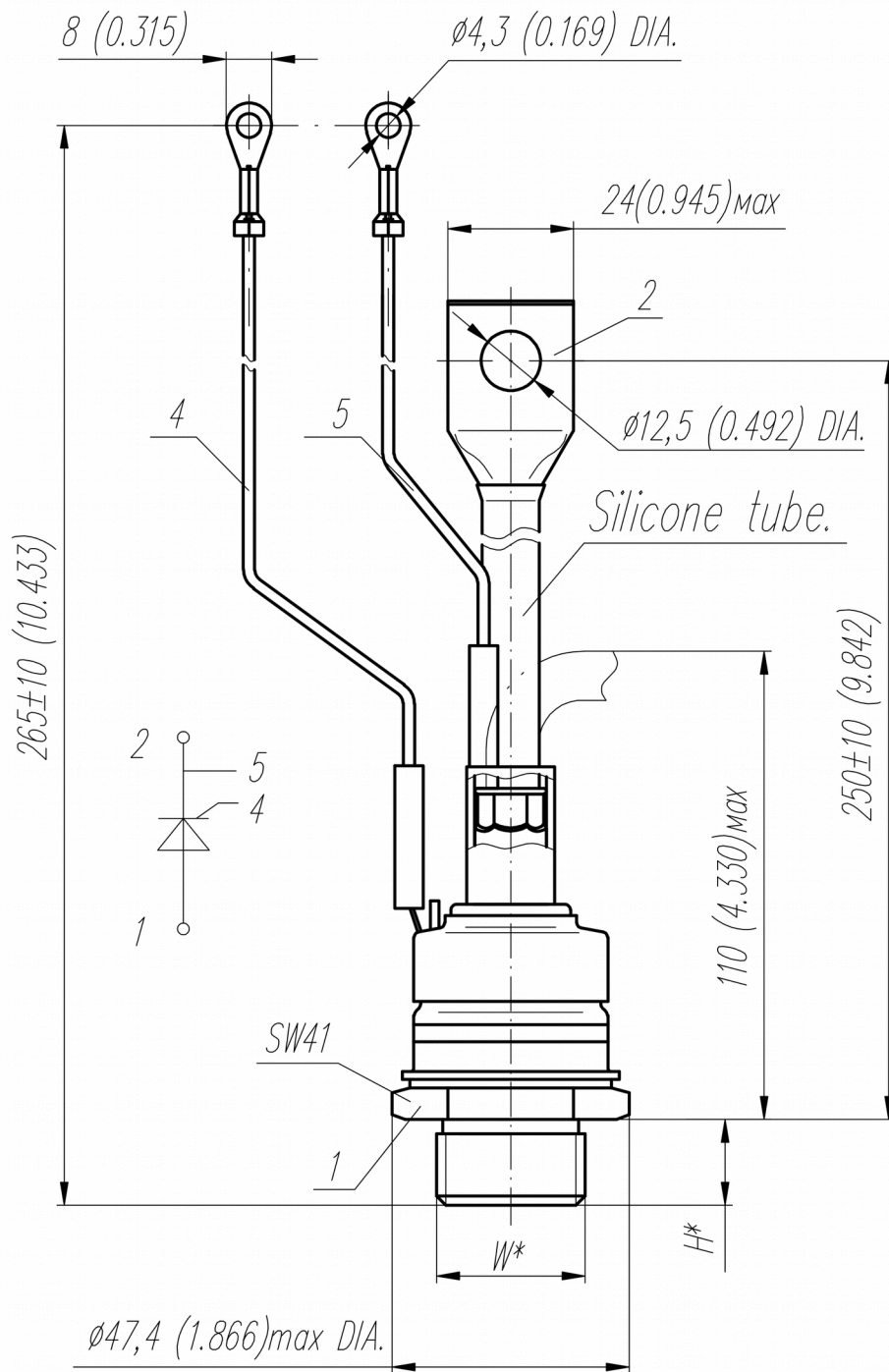

Type of screw	W	H
Metric Screw Type C	M24x1,5 – 8g	19
Metric Screw Type B (upon request)	M20x1,5 – 8g	15

Polarity	Example of code designation	Reference designation	Colors		
			Anode	Cathode	Gate
Anode to stud	TFI371-200-14		-	Red tube	White

All dimensions in millimeters (inches)

The information contained herein is confidential and protected by Copyright. In the interest of product improvement, Proton-Electrotex reserves the right to change data sheet without notice.