

High forward current capability
 Low forward losses
 Low thermal resistance
 High load cycle capability

Rectifier Diode For Welding Type D056-9500-4

Average forward current	I_{FAV}	11814 A
Repetitive peak reverse voltage	V_{RRM}	200 ÷ 400 V
V_{RRM}, V	200	400
Voltage code	2	4
$T_j, ^\circ C$	- 60 ÷ 180	

MAXIMUM ALLOWABLE RATINGS

Symbols and parameters		Units	Values	Test conditions
ON-STATE				
I_{FAV}	Average forward current	A	9500 10555 11814	$T_c=112\text{ }^\circ C$; Double side cooled; $T_c=100\text{ }^\circ C$; Double side cooled; $T_c=85\text{ }^\circ C$; Double side cooled; 180° half-sine wave; 50 Hz
I_{FRMS}	RMS forward current	A	14915	$T_c=112\text{ }^\circ C$; Double side cooled; 180° half-sine wave; 50 Hz
I_{FSM}	Surge forward current	kA	70.0 81.0	$T_j=T_{j\max}$ $T_j=25\text{ }^\circ C$ 180° half-sine wave; 50 Hz ($t_p=10\text{ ms}$); single pulse; $V_R=0\text{ V}$
			74.0 85.0	$T_j=T_{j\max}$ $T_j=25\text{ }^\circ C$ 180° half-sine wave; 60 Hz ($t_p=8.3\text{ ms}$); single pulse; $V_R=0\text{ V}$
I^2t	Safety factor	$A^2s \cdot 10^3$	24500 32805	$T_j=T_{j\max}$ $T_j=25\text{ }^\circ C$ 180° half-sine wave; 50 Hz ($t_p=10\text{ ms}$); single pulse; $V_R=0\text{ V}$
			22725 29980	$T_j=T_{j\max}$ $T_j=25\text{ }^\circ C$ 180° half-sine wave; 60 Hz ($t_p=8.3\text{ ms}$); single pulse; $V_R=0\text{ V}$
BLOCKING				
V_{RRM}	Repetitive peak reverse voltages	V	200 ÷ 400	$T_{j\min} < T_j < T_{j\max}$; 180° half-sine wave; 50 Hz;
V_{RSM}	Non-repetitive peak reverse voltages	V	250 ÷ 450	$T_{j\min} < T_j < T_{j\max}$; 180° half-sine wave; 50 Hz; single pulse;
V_R	Reverse continuous voltages	V	$0.75 \cdot V_{RRM}$	$T_j=T_{j\max}$;
THERMAL				
T_{stg}	Storage temperature	$^\circ C$	- 50 ÷ 40	
T_j	Operating junction temperature	$^\circ C$	- 60 ÷ 180	
MECHANICAL				
F	Mounting force	kN	45.0 ÷ 50.0	
a	Acceleration	m/s^2	50	Device unclamped
			100	Device clamped

CHARACTERISTICS

Symbols and parameters		Units	Values	Conditions
ON-STATE				
V_{FM}	Peak forward voltage, max	V	1.08 0.98	$T_j=25\text{ }^\circ\text{C}; I_{FM} = 6300\text{ A}$ $T_j=T_{j\text{ max}}; I_{FM} = 8000\text{ A}$
$V_{F(TO)}$	Forward threshold voltage, max	V	0.74	$T_j=T_{j\text{ max}};$
r_T	Forward slope resistance, max	m Ω	0.030	$5000\text{ A} < I_T < 14000\text{ A}$
BLOCKING				
I_{RRM}	Repetitive peak reverse current, max	mA	50	$T_j=T_{j\text{ max}};$ $V_R=V_{RRM}$
SWITCHING				
Q_{rr}	Total recovered charge, max	μC	1150	$T_j=T_{j\text{ max}}; I_{FM}=1000\text{ A};$ $di_{FM}/dt=-30\text{ A}/\mu\text{s};$
			720	$T_j=T_{j\text{ max}}; I_{FM}=1000\text{ A};$ $di_{FM}/dt=-10\text{ A}/\mu\text{s};$
THERMAL				
R_{thjc}	Thermal resistance, junction to case, max	$^\circ\text{C}/\text{W}$	0.0050	Double side cooled
R_{thjc-A}			0.0070	Anode side cooled
R_{thjc-K}			0.0150	Cathode side cooled
R_{thck}	Thermal resistance, case to heatsink, max		0.0035	Direct Current
MECHANICAL				
w	Weight, typ	g	110	
D_s	Surface creepage distance	mm (inch)	2.0 (0.079)	
D_a	Air strike distance	mm (inch)	2.0 (0.079)	

PART NUMBERING GUIDE

D	056	9500	4	N
1	2	3	4	

1. Design version
2. Average forward current, A
3. Voltage code
4. Ambient conditions: N – normal

De-rating Main characteristics vs Mounting force

Symbols and parameters		Units	Values (F=30 kN)	Values (F=40 kN)	Conditions
I_{FAV}	Average forward current	A	9495	10127	$T_c= 100\text{ }^\circ\text{C};$ Double side cooled; 180° half-sine wave; 50 Hz
V_{FM}	Peak forward voltage, max	V	1.10 1.00	1.09 0.99	$T_j=25\text{ }^\circ\text{C}; I_{FM} = 6300\text{ A}$ $T_j=T_{j\text{ max}}; I_{FM} = 8000\text{ A}$
$V_{F(TO)}$	Forward threshold voltage, max	V	0.76	0.75	$T_j=T_{j\text{ max}};$
r_T	Forward slope resistance, max	m Ω	0.032	0.031	$5000\text{ A} < I_T < 14000\text{ A}$
R_{thjc}	Thermal resistance, junction to case, max	$^\circ\text{C}/\text{W}$	0.0056	0.0052	Double side cooled
R_{thjc-A}			0.0080	0.0076	Anode side cooled
R_{thjc-K}			0.0165	0.0155	Cathode side cooled

OVERALL DIMENSIONS

Package type: **HOUSINGLESS**

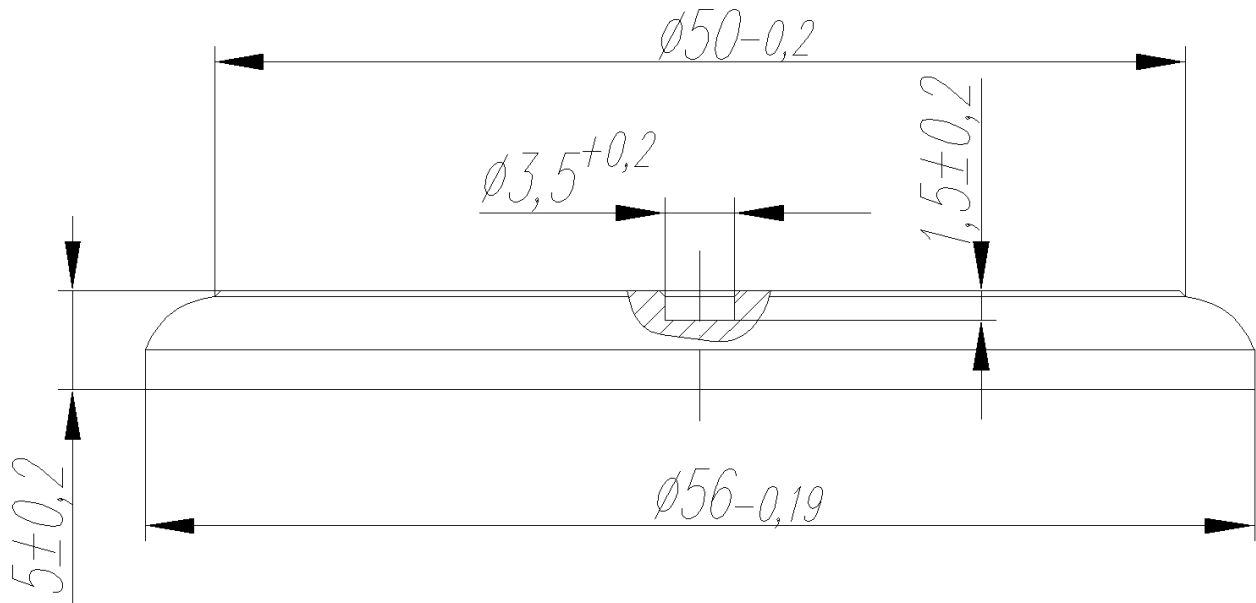

All dimensions in millimeters (inches)

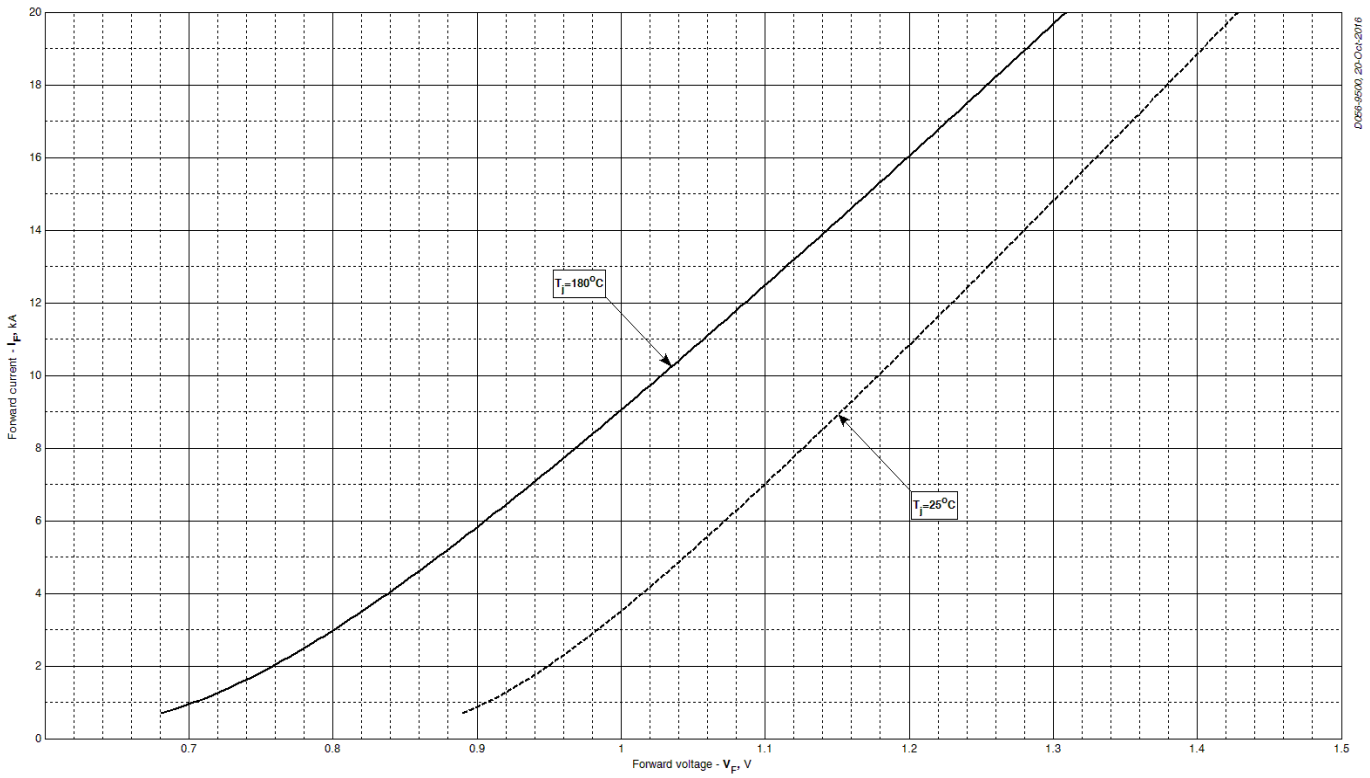

Fig 1 – Forward characteristics of Limit device

$$V_F = A + B \cdot i_F + C \cdot \ln(i_F + 1) + D \cdot \sqrt{i_F}$$

	Coefficients for max curves	
	$T_j = 25^\circ\text{C}$	$T_j = T_{j\text{max}}$
A	0.907474	0.779908
B	0.019903	0.028250
C	0.069432	0.147664
D	-0.037894	-0.080592

Forward characteristic model (see Fig. 1).

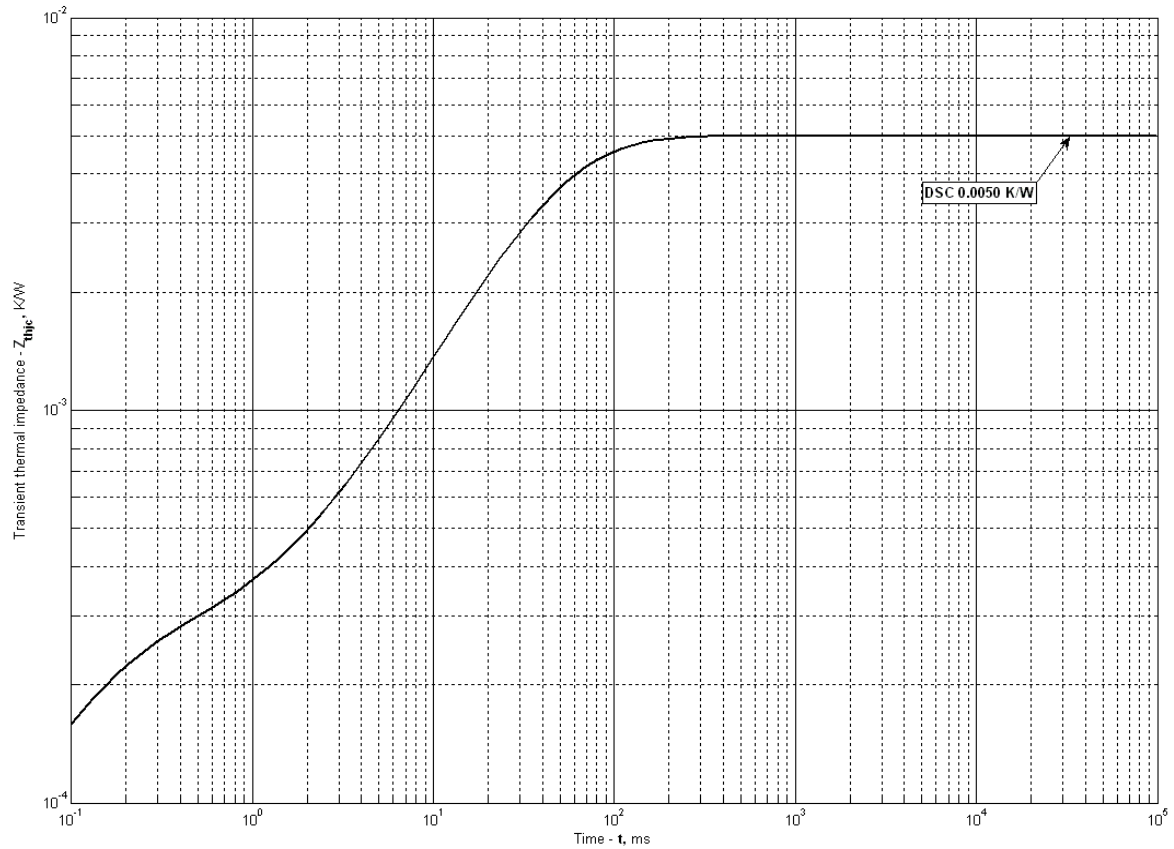

Fig 2 – Transient thermal impedance

$$Z_{thjc} = \sum_{i=1}^n R_i \left(1 - e^{-\frac{t}{\tau_i}} \right)$$

Where $i = 1$ to n , n is the number of terms in the series.

t = Duration of heating pulse in seconds.

Z_{thjc} = Thermal resistance at time t .

R_i = Amplitude of p_{th} term.

τ_i = Time constant of r_{th} term.

DC Double side cooled

i	1	2	3	4	5	6
R_i , K/W	0.0009858	0.003751	0.00001625	0.00001224	0.0001735	0.00006128
τ_i , S	0.07476	0.03287	0.007701	0.001065	0.0001313	0.00005139

Transient thermal impedance junction to case Z_{thjc} model (see Fig. 2)

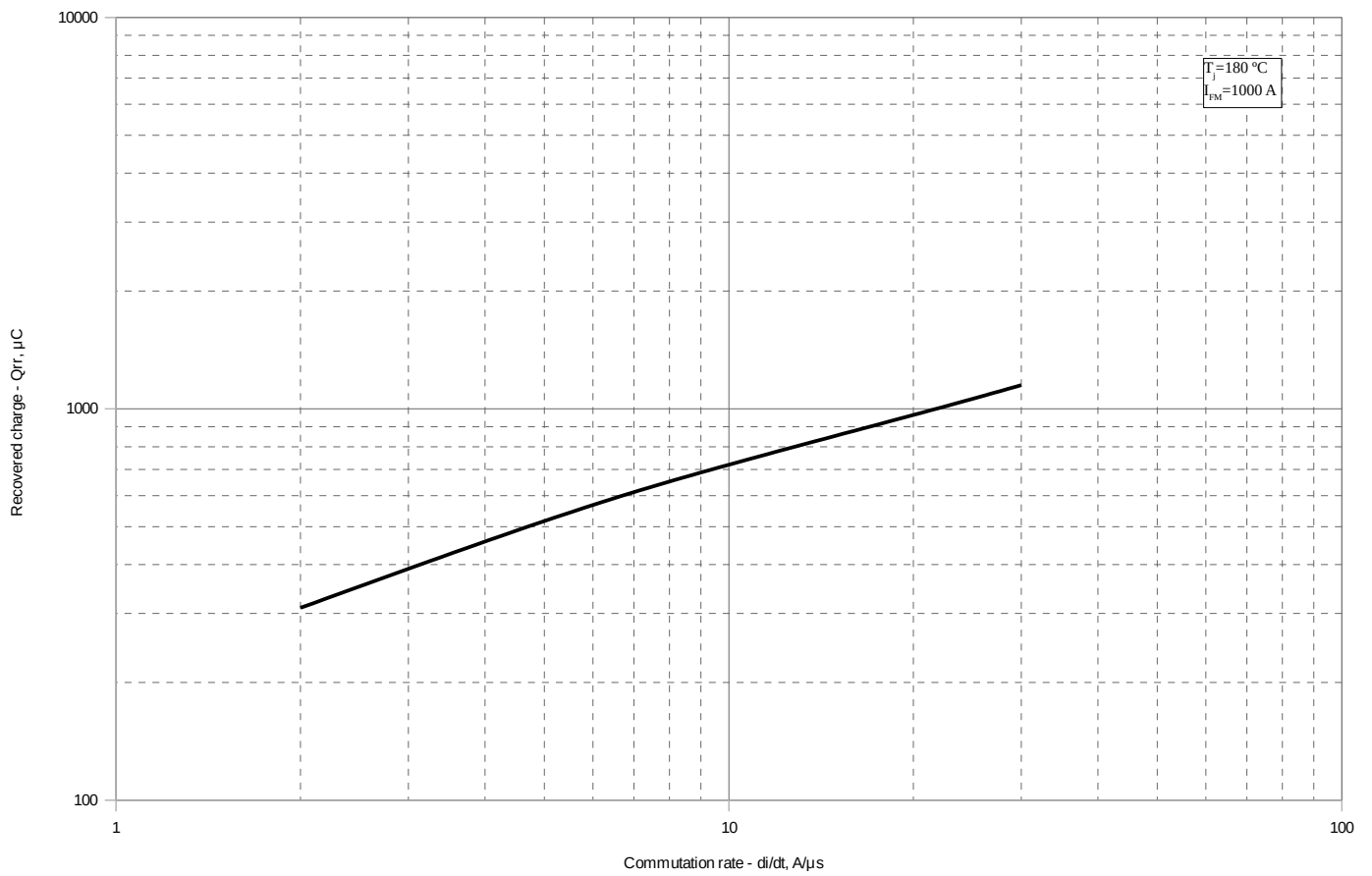

Fig 3 - Recovered charge, Q_{rr}

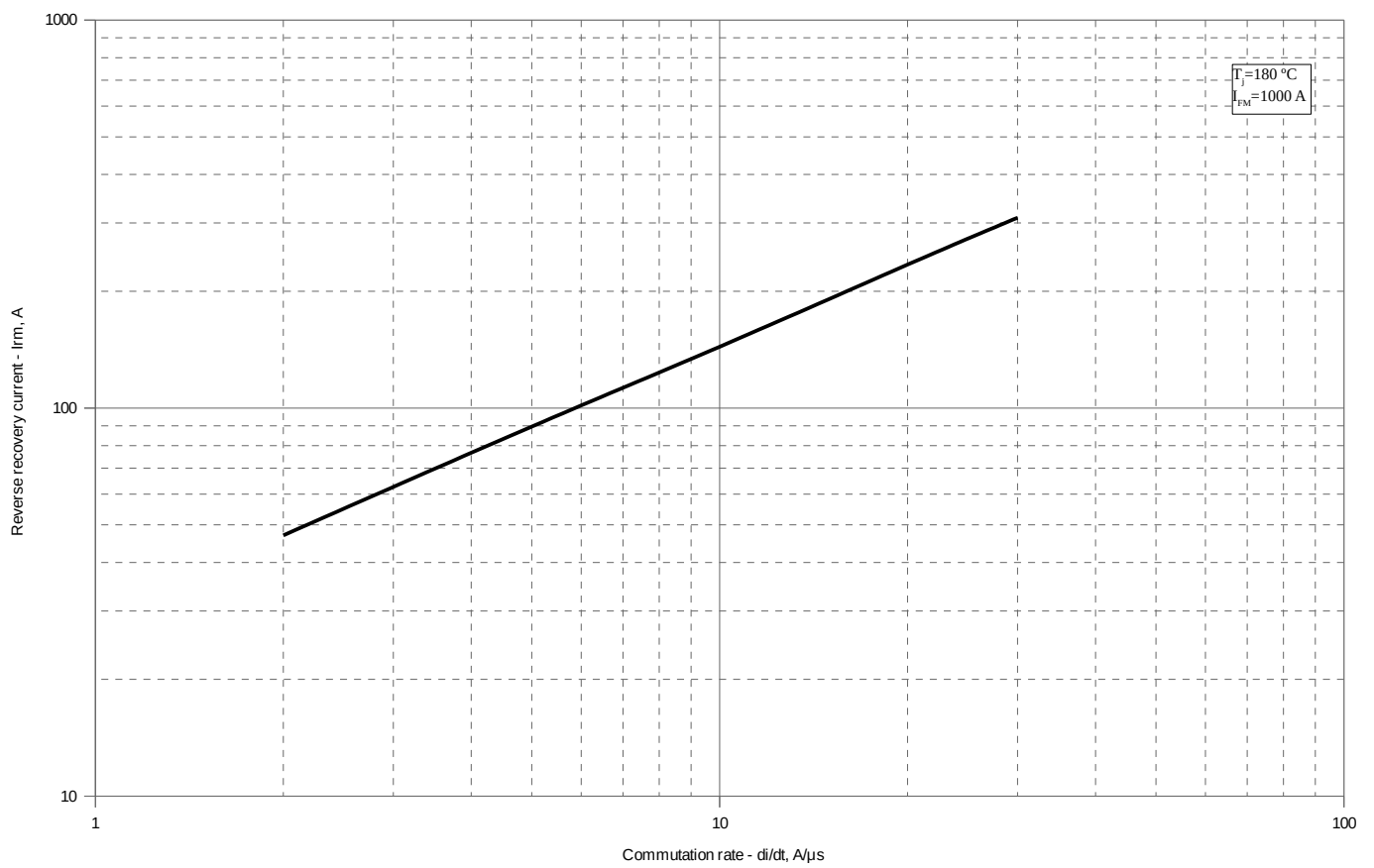

Fig 4 – Peak reverse recovery current, I_{rm}

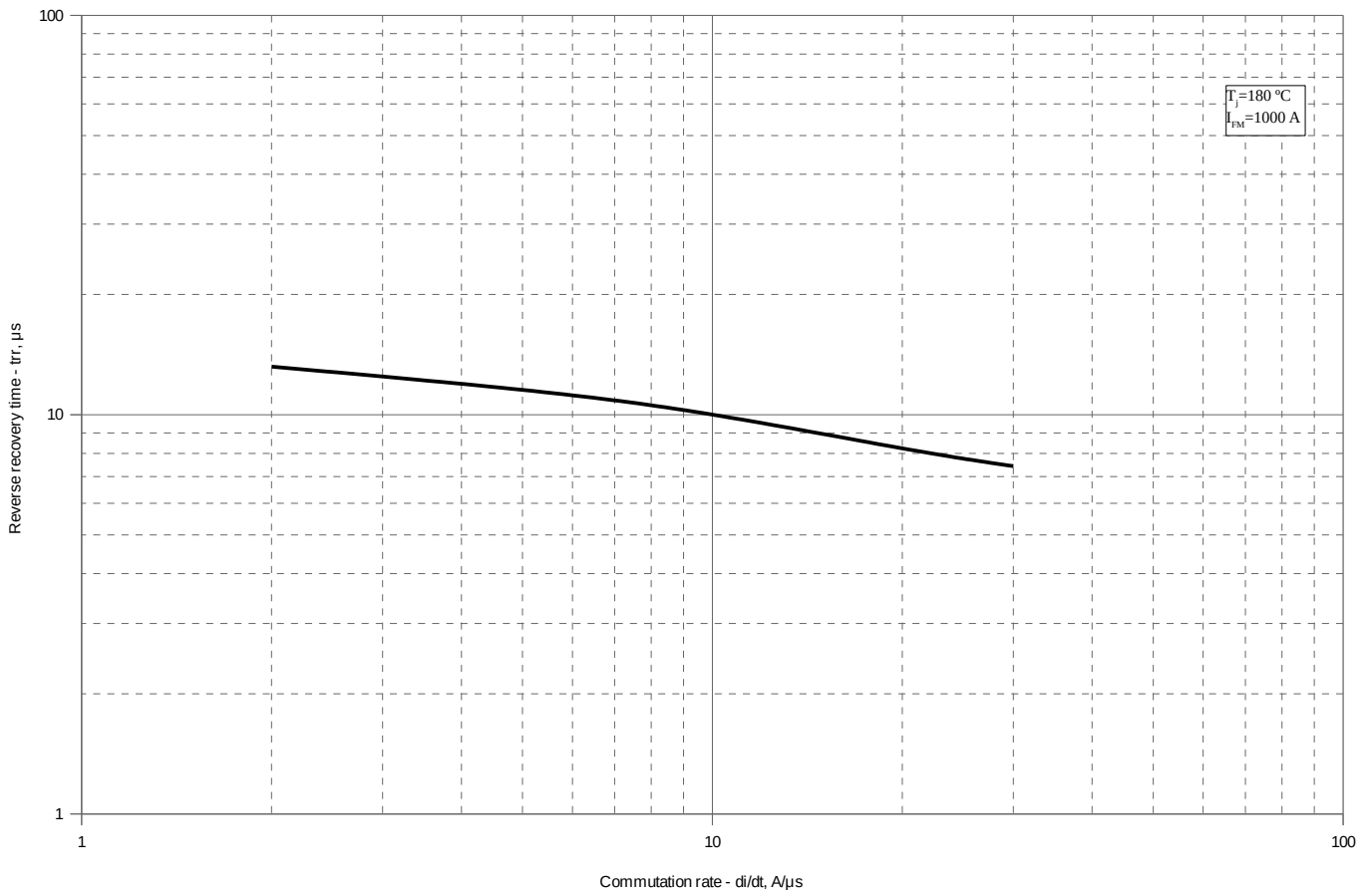

Fig 5 – Maximum recovery time, t_{rr} (linear)

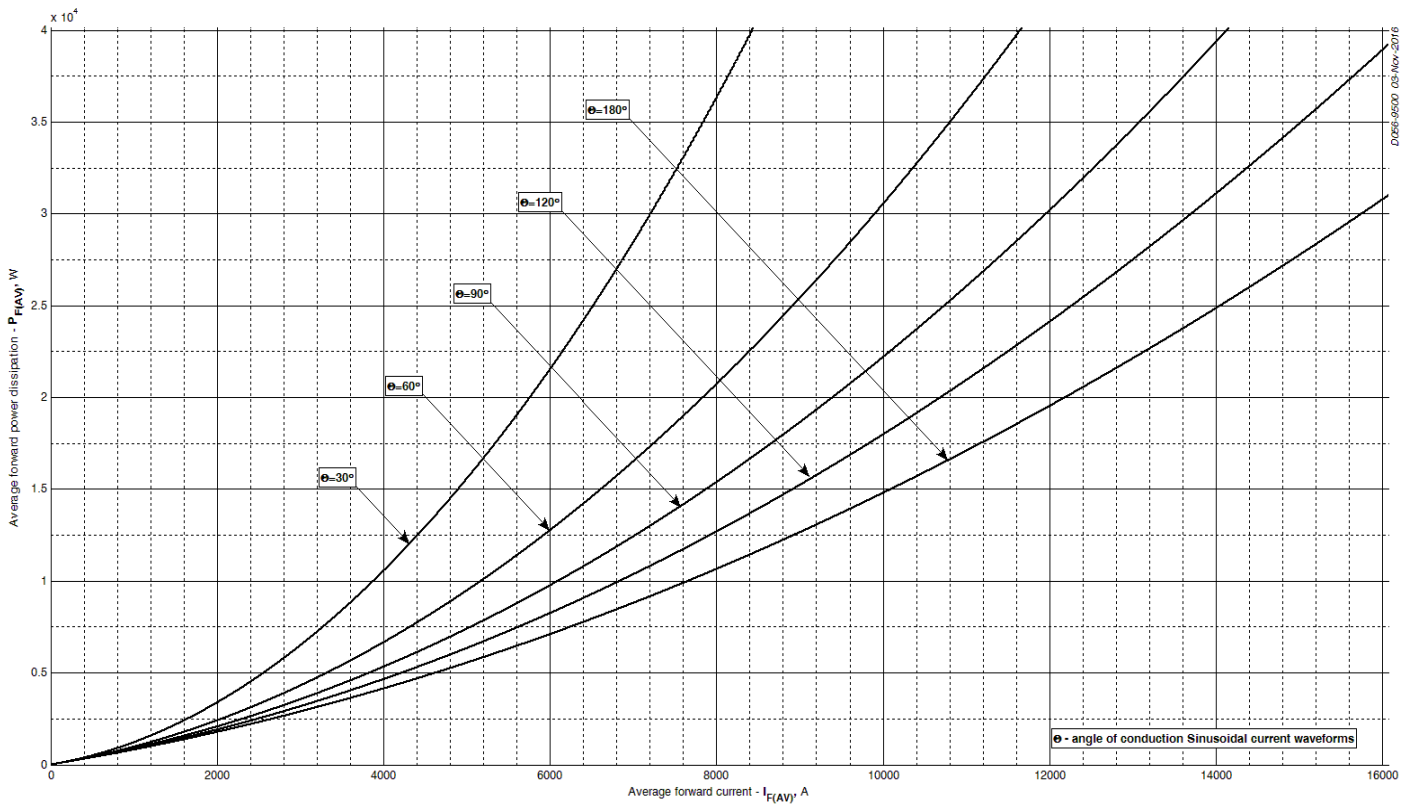

Fig 6 – Mean forward power dissipation P_{FAV} vs. Mean forward current I_{FAV} for sinusoidal current waveforms at different conduction angles ($f=50\text{Hz}$, DSC)

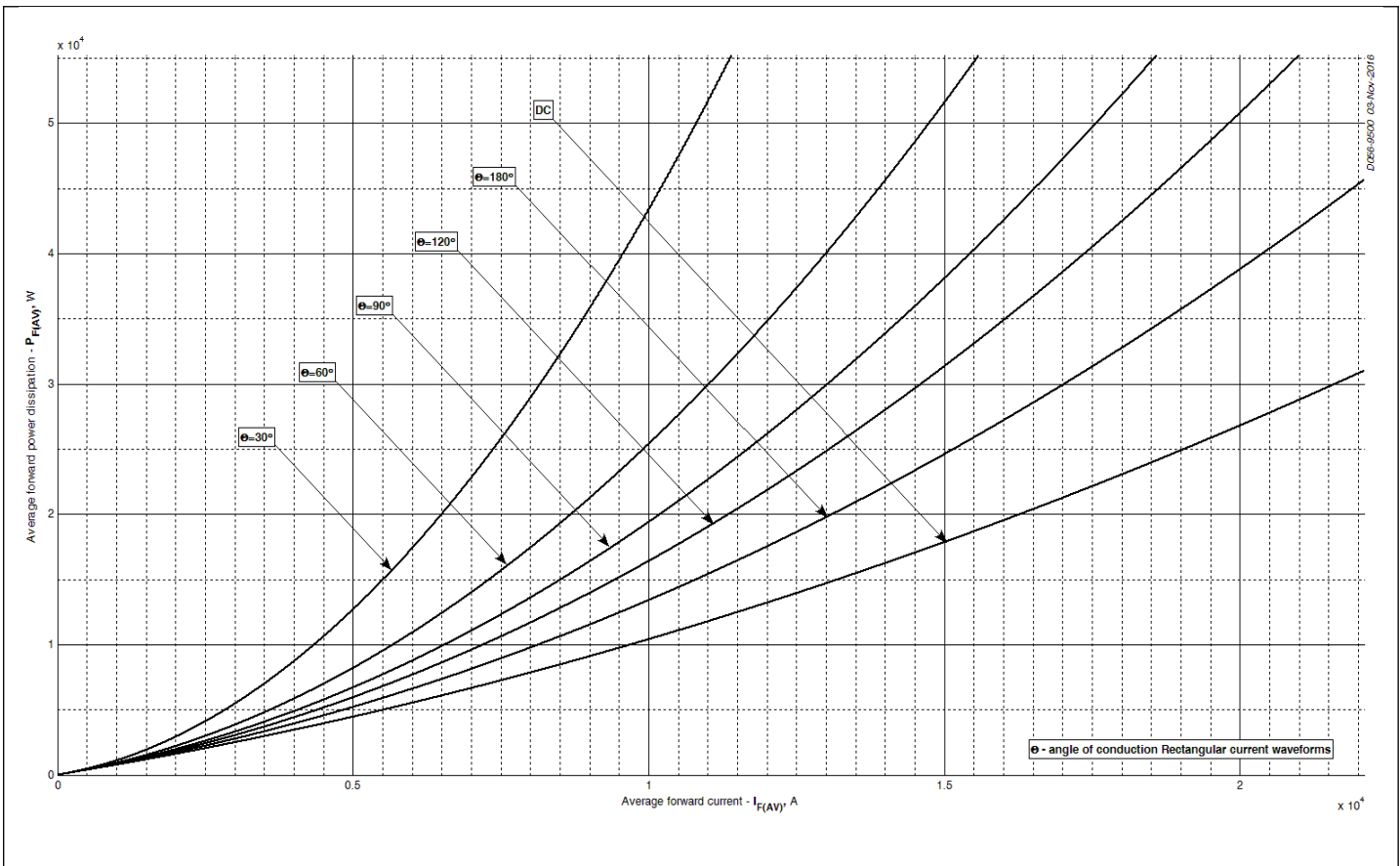

Fig 7 – Mean forward power dissipation P_{FAV} vs. Mean forward current I_{FAV} for rectangular current waveforms at different conduction angles and for DC (f=50Hz, DSC)

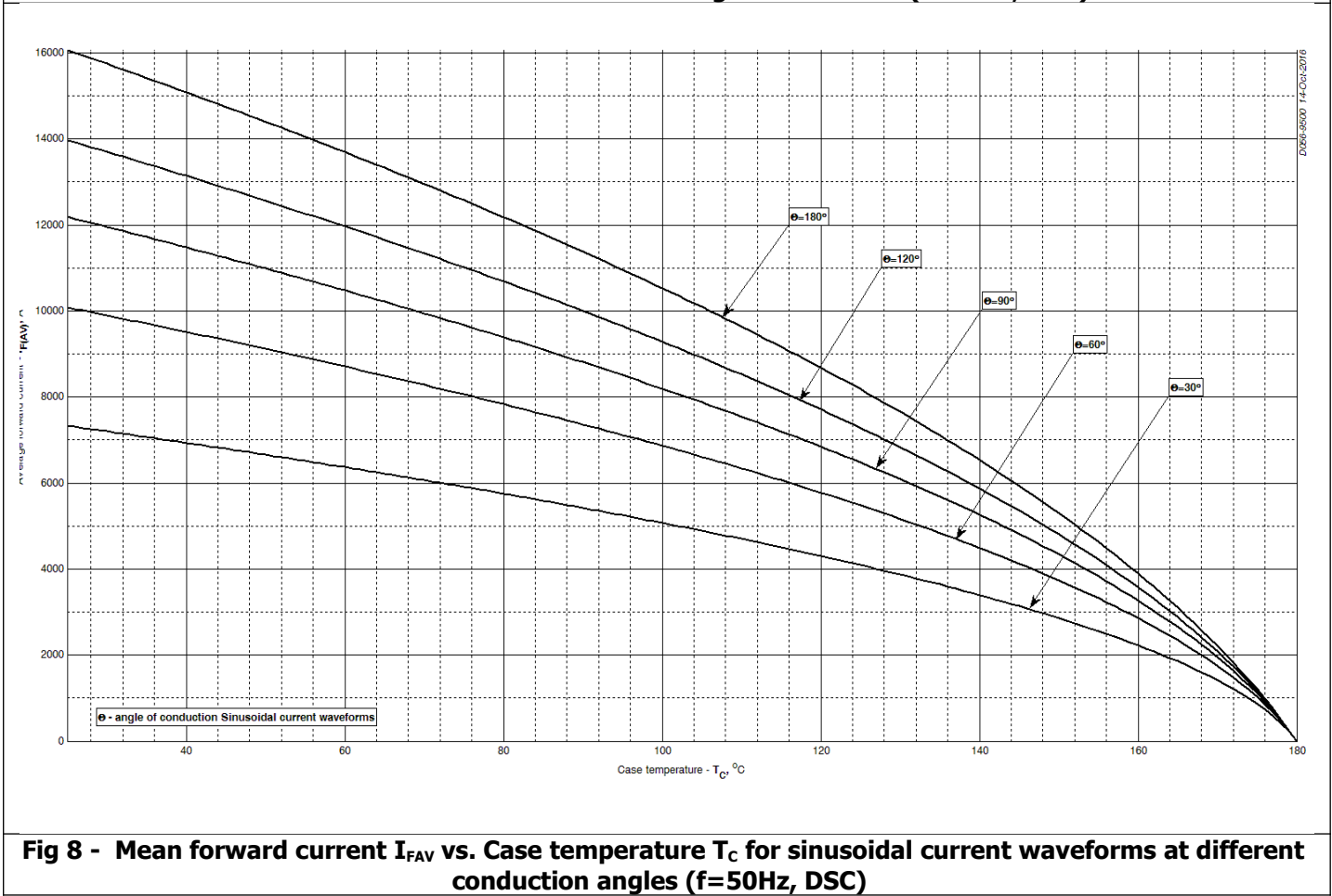

Fig 8 - Mean forward current I_{FAV} vs. Case temperature T_C for sinusoidal current waveforms at different conduction angles (f=50Hz, DSC)

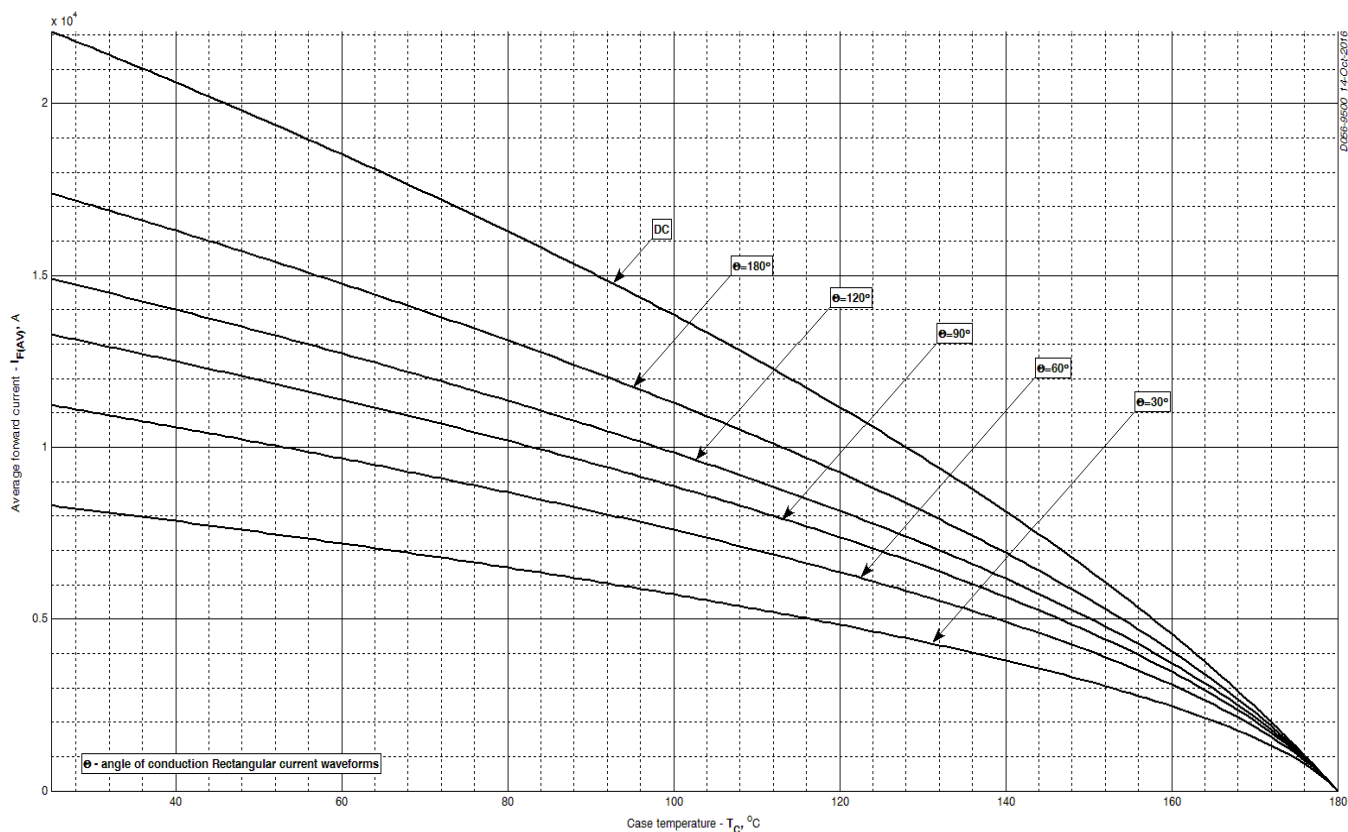

Fig 9 – Mean forward current I_{FAV} vs. Case temperature T_c for rectangular current waveforms at different conduction angles and for DC ($f=50Hz$, DSC)

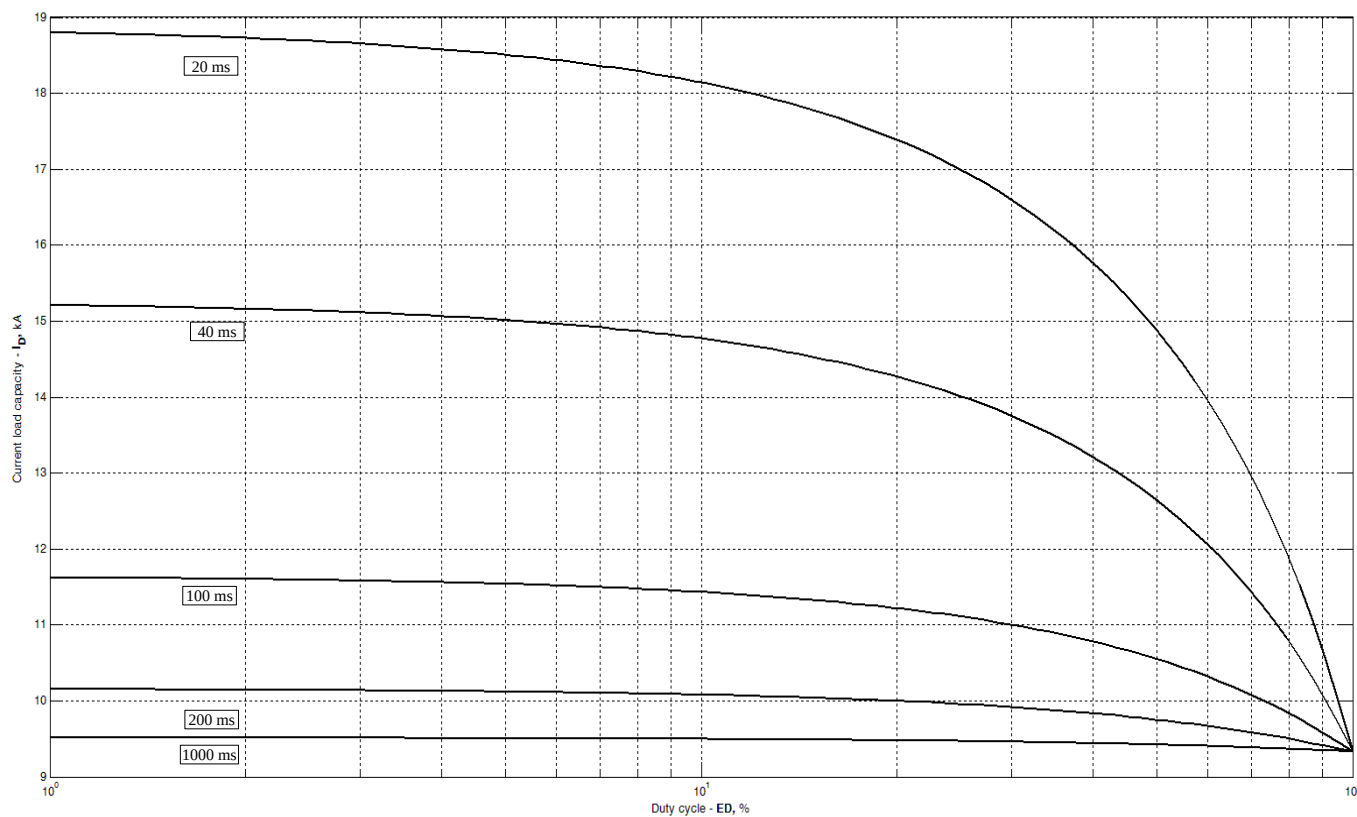

Fig 10 – Current load capability ($f=1000$ Hz, square wave, $T_c = 40^{\circ}C$)

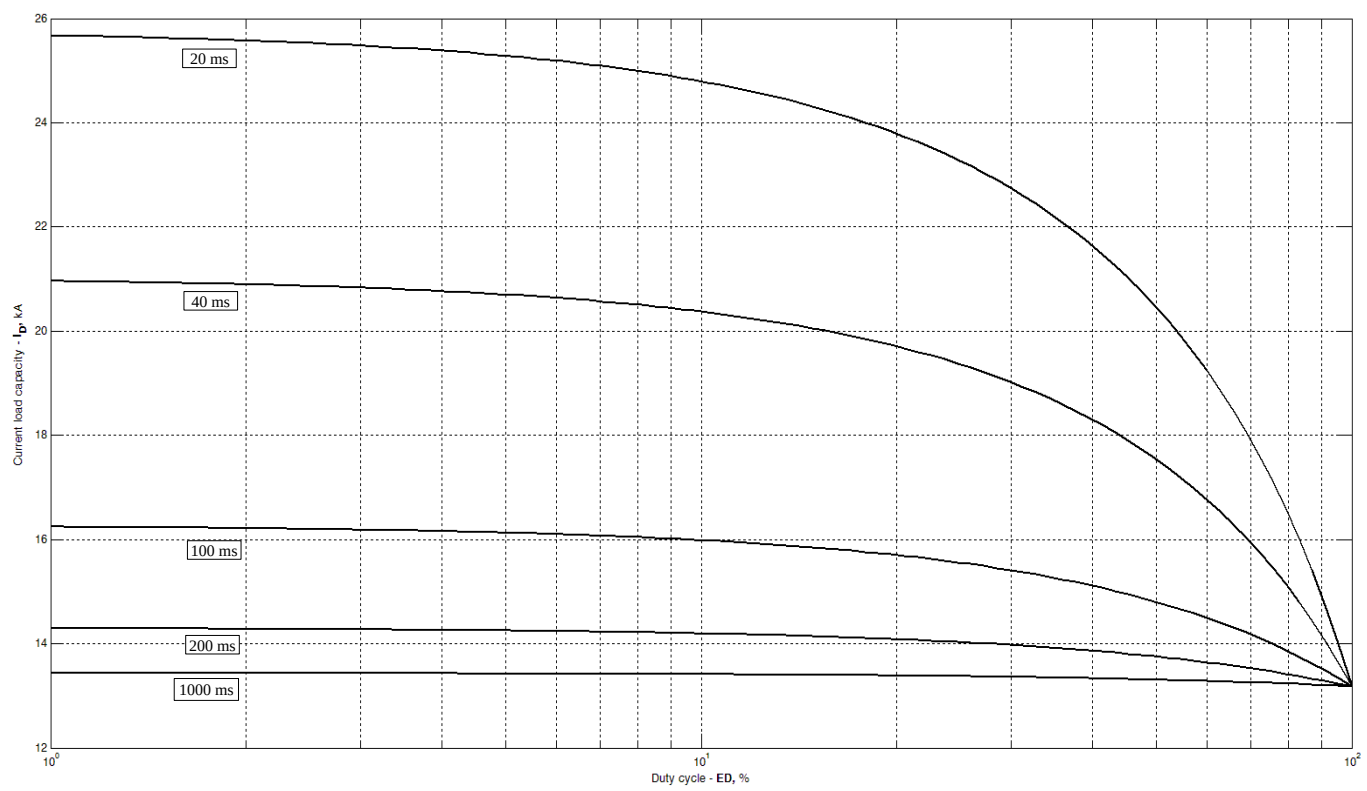

Fig 11 – Current load capability (f=1000 Hz, square wave, T_c = 60 °C)

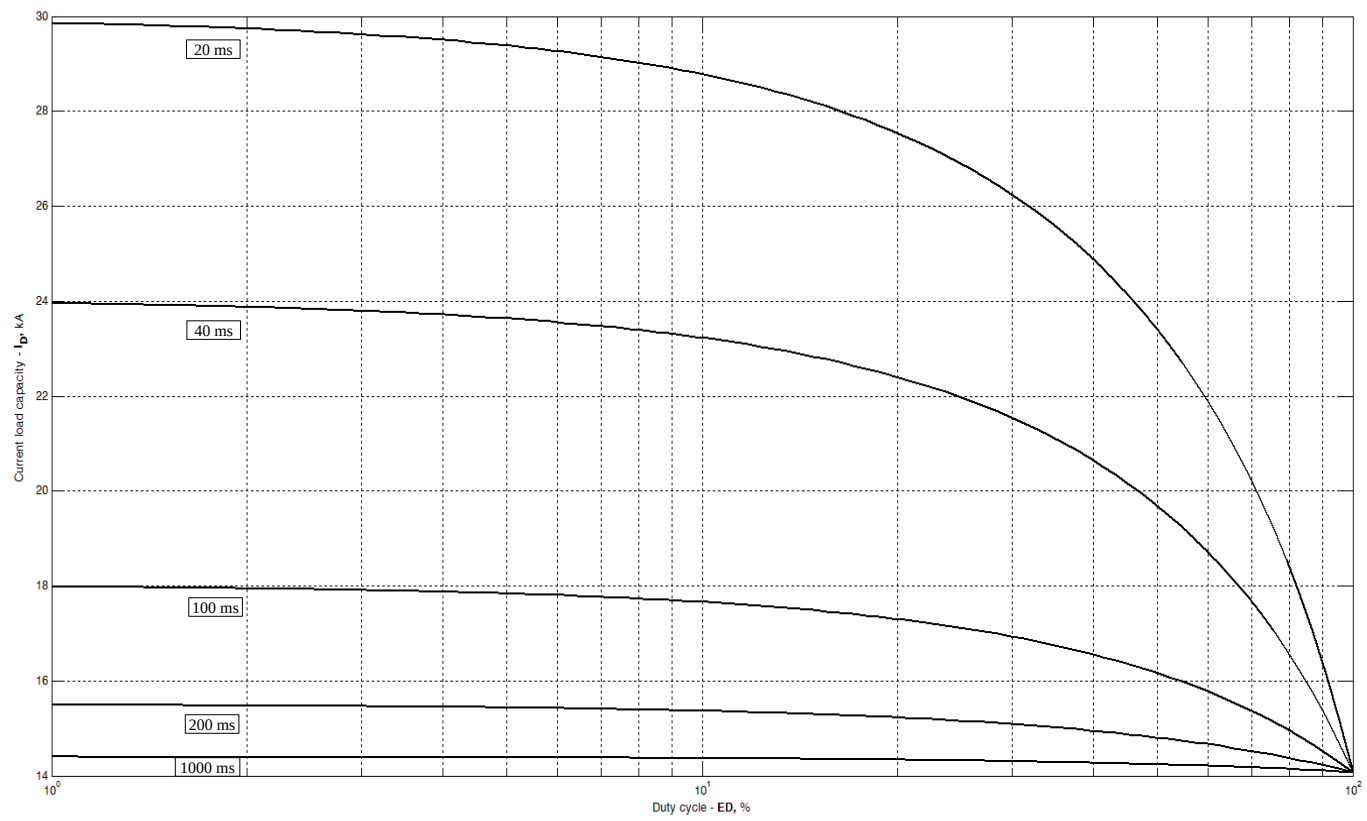

Fig 12 – Current load capability (f=1000 Hz, square wave, T_c = 70 °C)

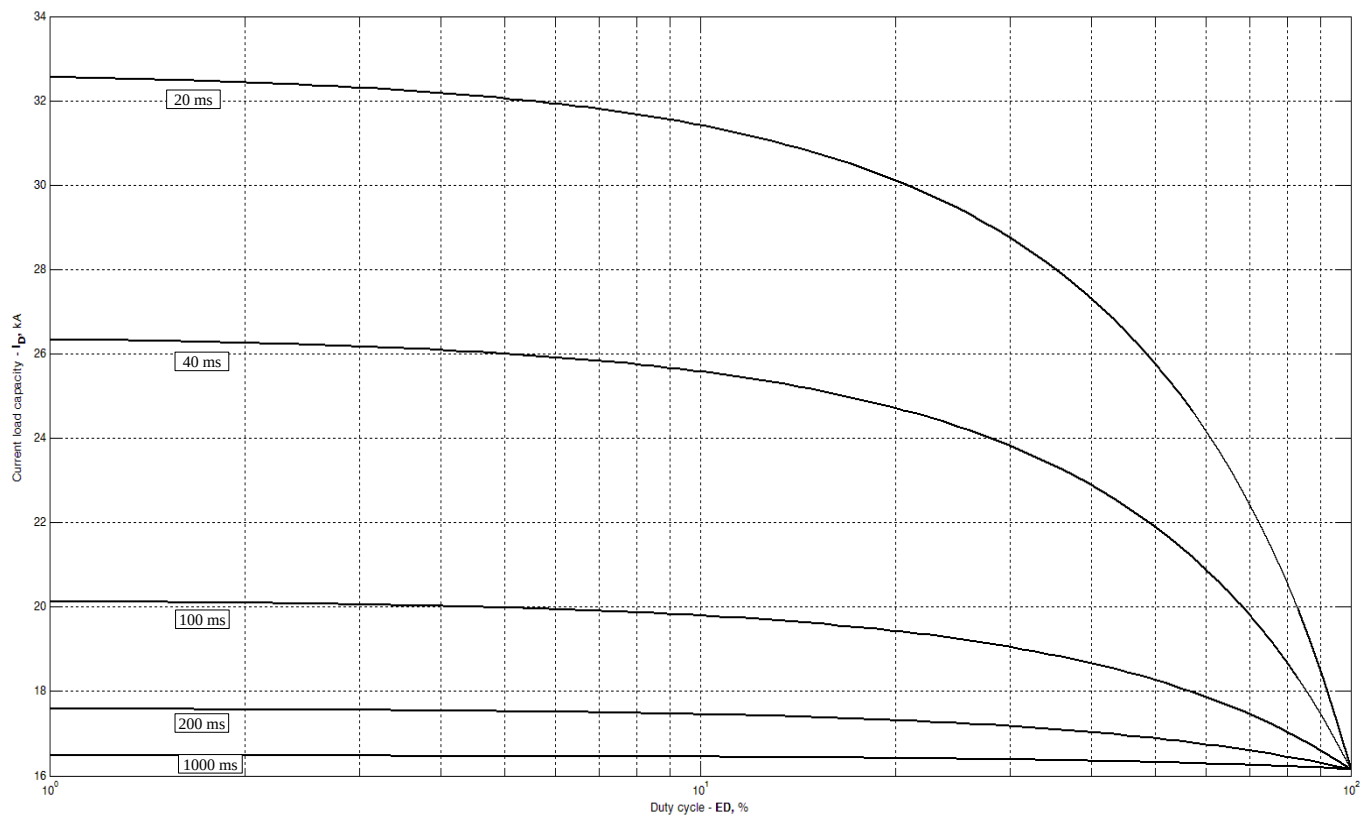

Fig 13 – Current load capability (f=1000 Hz, square wave, $T_c = 80\text{ }^\circ\text{C}$)

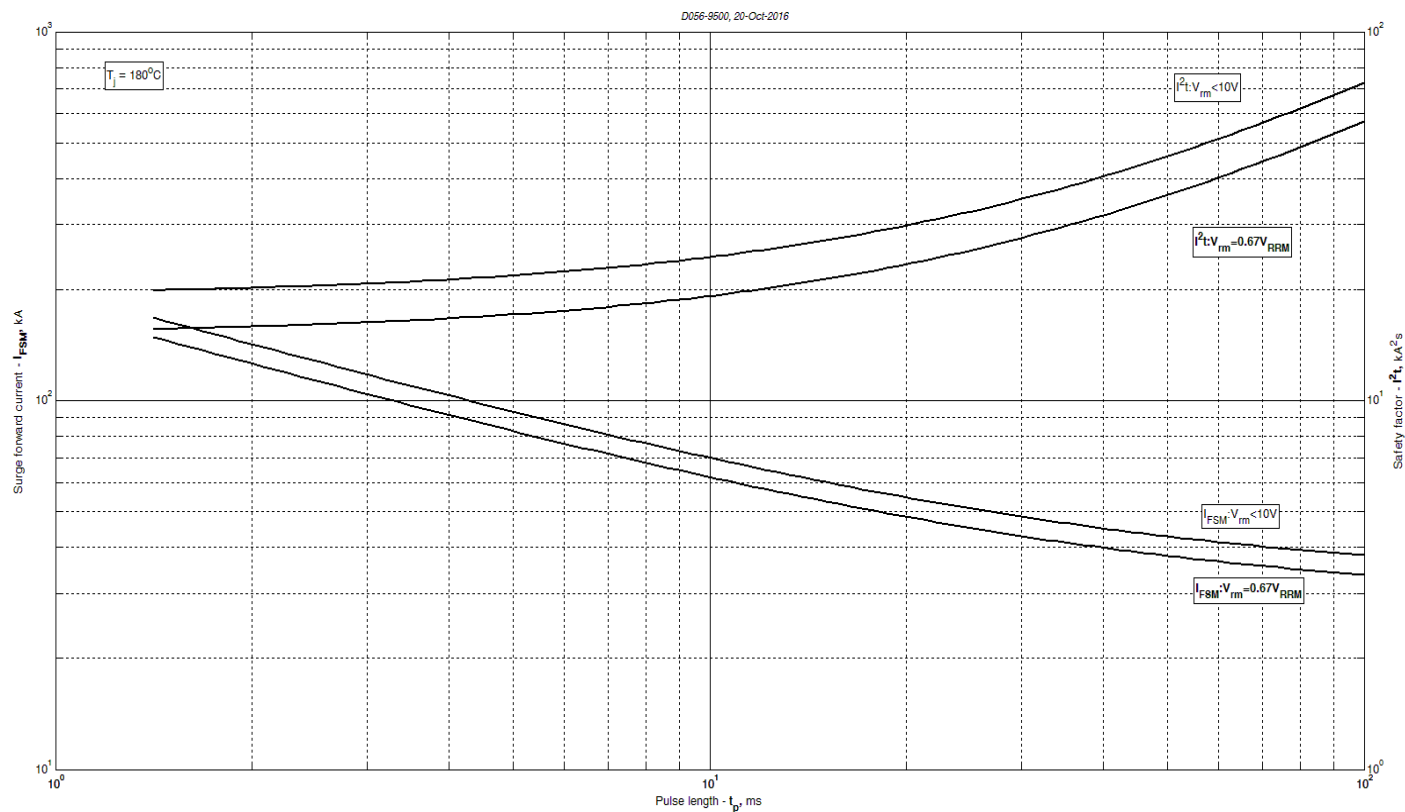

Fig 14 – Maximum surge and I^2t ratings

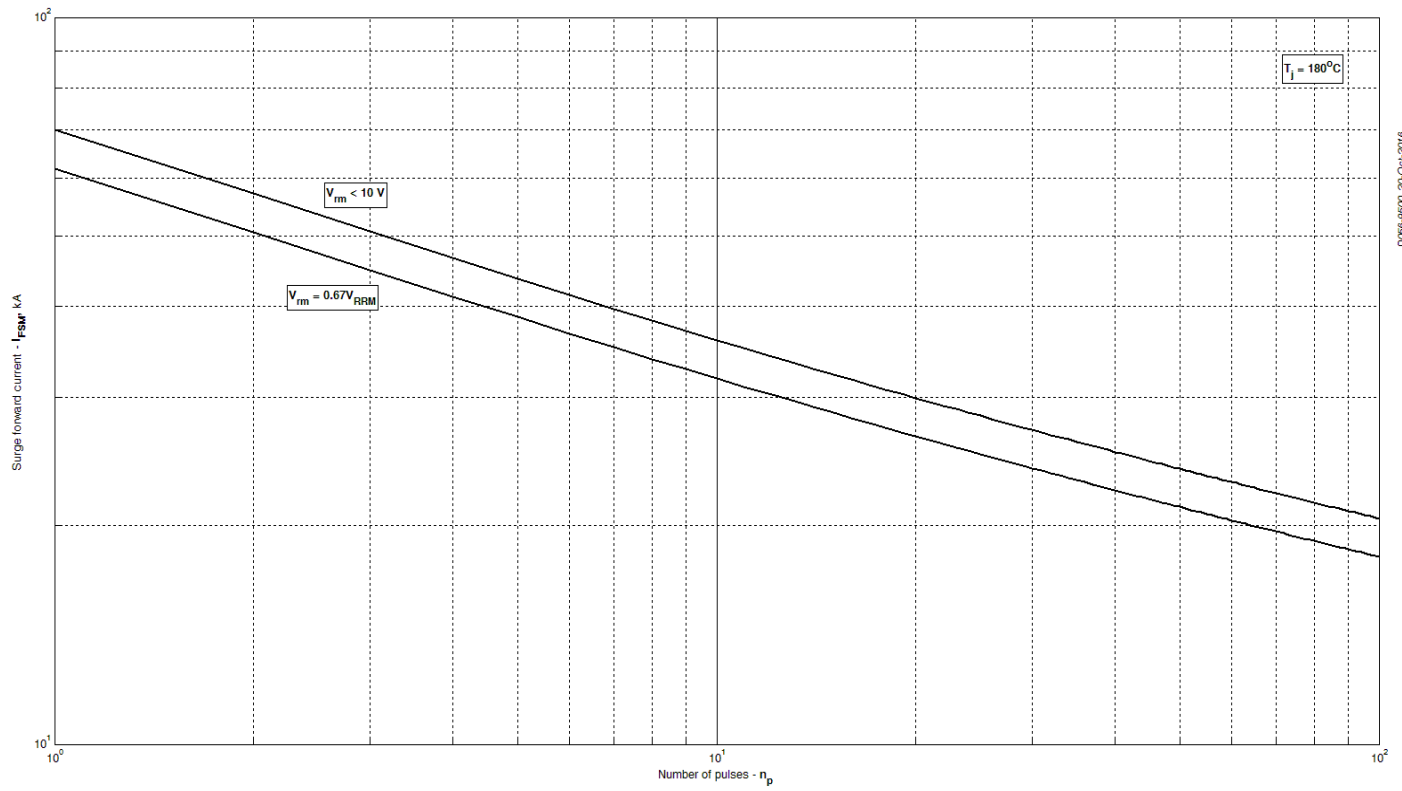

Fig 15 – Maximum surge ratings

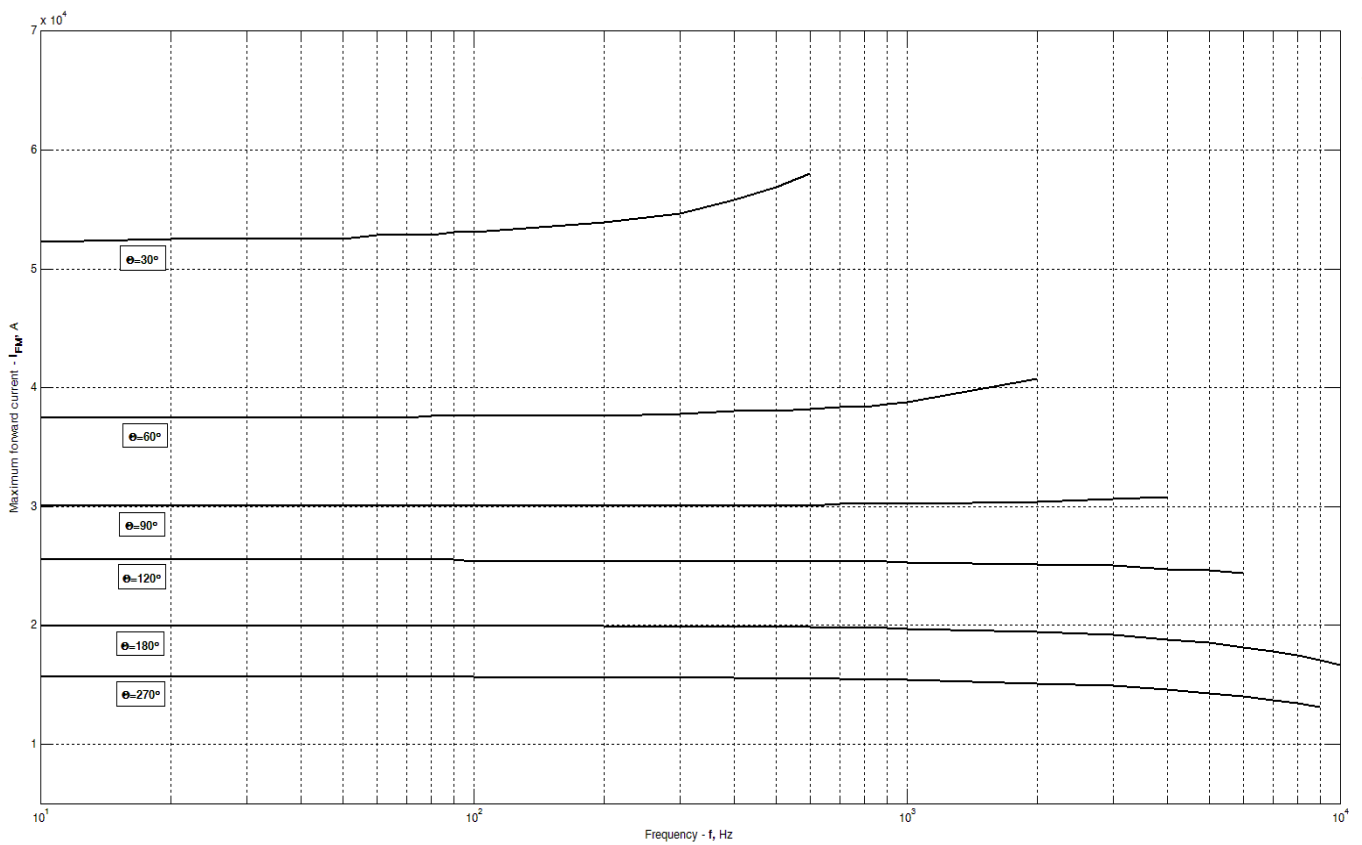
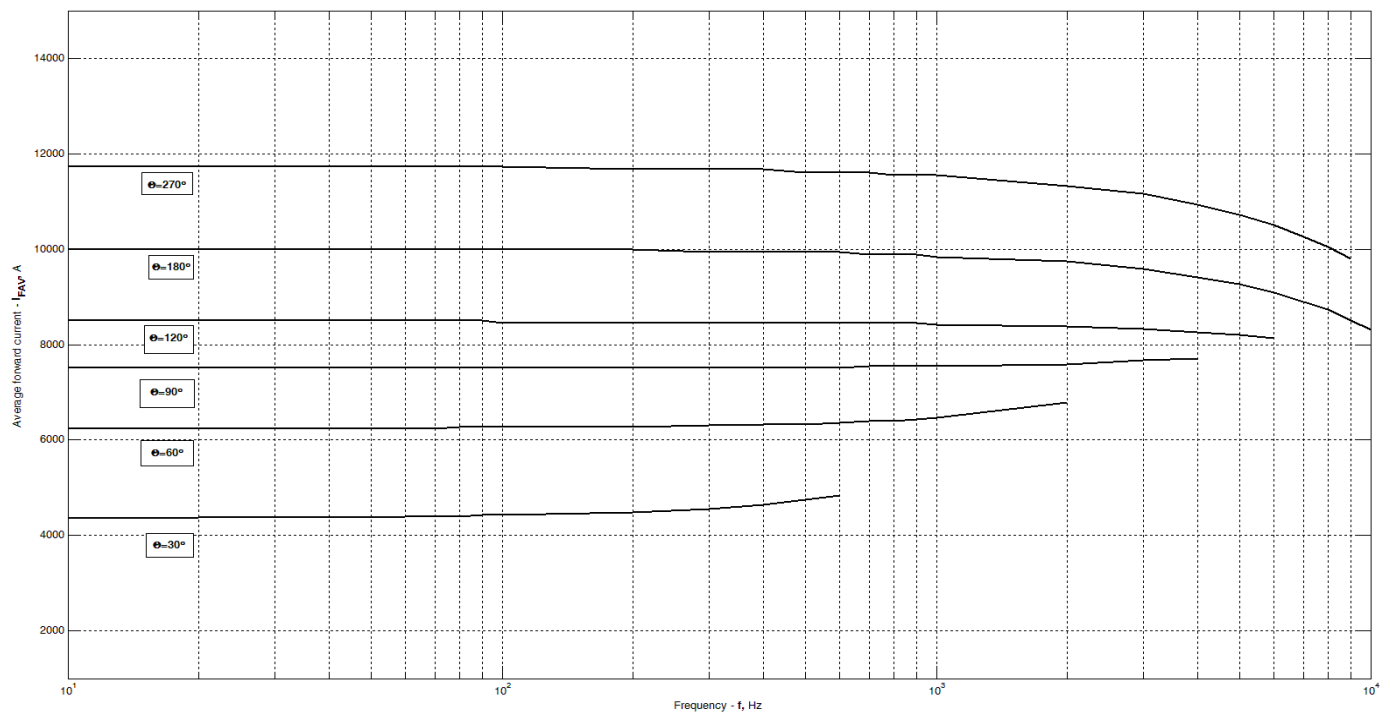

Fig 16 – Maximum forward current vs. frequency, trapezoid waveform, $T_C = 85^\circ C$, $di_F/dt = \pm 500 A/\mu s$, $V_R = 100 V$



**Fig 17 –Average forward current vs. frequency, trapezoid waveform,
 $T_c=85^\circ\text{C}$, $di_F/dt=\pm 500\text{ A}/\mu\text{s}$, $V_R=100\text{ V}$**