

High forward current capability
 Low forward losses
 Low thermal resistance
 High load cycle capability

Rectifier Diode For Welding Type D063-11500-4

Average forward current	I_{FAV}	11500 A
Repetitive peak reverse voltage	V_{RRM}	200 ÷ 400 V
V_{RRM}, V	200	400
Voltage code	2	4
$T_j, ^\circ C$	- 60 ÷ 180	

MAXIMUM ALLOWABLE RATINGS

Symbols and parameters		Units	Values	Test conditions
ON-STATE				
I_{FAV}	Average forward current	A	11500 11298 10061	$T_c=82^\circ C$; Double side cooled; $T_c=85^\circ C$; Double side cooled; $T_c=100^\circ C$; Double side cooled; 180° half-sine wave; 50 Hz
I_{FRMS}	RMS forward current	A	18055	$T_c=82^\circ C$; Double side cooled; 180° half-sine wave; 50 Hz
I_{FSM}	Surge forward current	kA	85.0 98.0	$T_j=T_{jmax}$ $T_j=25^\circ C$ 180° half-sine wave; 50 Hz ($t_p=10$ ms); single pulse; $V_R=0$ V
			90.0 104.0	$T_j=T_{jmax}$ $T_j=25^\circ C$ 180° half-sine wave; 60 Hz ($t_p=8.3$ ms); single pulse; $V_R=0$ V
I^2t	Safety factor	$A^2s \cdot 10^3$	36125 48020	$T_j=T_{jmax}$ $T_j=25^\circ C$ 180° half-sine wave; 50 Hz ($t_p=10$ ms); single pulse; $V_R=0$ V
			33615 44885	$T_j=T_{jmax}$ $T_j=25^\circ C$ 180° half-sine wave; 60 Hz ($t_p=8.3$ ms); single pulse; $V_R=0$ V
BLOCKING				
V_{RRM}	Repetitive peak reverse voltages	V	200 ÷ 400	$T_{jmin} < T_j < T_{jmax}$; 180° half-sine wave; 50 Hz
V_{RSM}	Non-repetitive peak reverse voltages	V	250 ÷ 450	$T_{jmin} < T_j < T_{jmax}$; 180° half-sine wave; 50 Hz; single pulse
V_R	Reverse continuous voltages	V	$0.75 \cdot V_{RRM}$	$T_j=T_{jmax}$
THERMAL				
T_{stg}	Storage temperature	$^\circ C$	- 50 ÷ 60	
T_j	Operating junction temperature	$^\circ C$	- 60 ÷ 180	
MECHANICAL				
F	Mounting force	kN	60.0 ÷ 70.0	
a	Acceleration	m/s^2	50	Device unclamped
			100	Device clamped

CHARACTERISTICS

Symbols and parameters		Units	Values	Conditions	
ON-STATE					
V_{FM}	Peak forward voltage, max	V	1.05 0.94	$T_j=25\text{ }^\circ\text{C}; I_{FM}=6300\text{ A}$ $T_j=T_{j\text{ max}}; I_{FM}=8000\text{ A}$	
$V_{F(TO)}$	Forward threshold voltage, max	V	0.73	$T_j=T_{j\text{ max}};$	
r_T	Forward slope resistance, max	m Ω	0.026	$6300\text{ A} < I_T < 14000\text{ A}$	
BLOCKING					
I_{RRM}	Repetitive peak reverse current, max	mA	50	$T_j=T_{j\text{ max}};$ $V_R=V_{RRM}$	
SWITCHING					
Q_{rr}	Total recovered charge, max	μC	1250	$T_j=T_{j\text{ max}}; I_{FM}=1000\text{ A};$ $di_{FM}/dt=-30\text{ A}/\mu\text{s};$	
			780	$T_j=T_{j\text{ max}}; I_{FM}=1000\text{ A};$ $di_{FM}/dt=-10\text{ A}/\mu\text{s};$	
THERMAL					
R_{thjc}	Thermal resistance, junction to case, max	$^\circ\text{C}/\text{W}$	0.0058	Direct Current	Double side cooled
R_{thjc-A}			0.0130		Anode side cooled
R_{thjc-K}			0.0104		Cathode side cooled
R_{thck}	Thermal resistance, case to heatsink, max		0.0030	Direct Current	
MECHANICAL					
w	Weight, typ	g	220		
D_s	Surface creepage distance	mm (inch)	4.0 (0.157)		
D_a	Air strike distance	mm (inch)	4.0 (0.157)		

PART NUMBERING GUIDE

D	063	11500	4	N
1	2	3	4	

1. Design version
2. Average forward current, A
3. Voltage code
4. Ambient conditions: N – normal

De-rating Main characteristics vs Mounting force

Symbols and parameters		Units	Values (F=35 kN)	Values (F=40 kN)	Values (F=50 kN)	Conditions
I_{FAV}	Average forward current	A	7522	8073	8691	$T_c=100\text{ }^\circ\text{C};$ Double side cooled; 180° half-sine wave; 50 Hz
V_{FM}	Peak forward voltage, max	V	1.07 0.96	1.07 0.96	1.06 0.95	$T_j=25\text{ }^\circ\text{C}; I_{FM}=6300\text{ A}$ $T_j=T_{j\text{ max}}; I_{FM}=8000\text{ A}$
$V_{F(TO)}$	Forward threshold voltage, max	V	0.75	0.75	0.74	$T_j=T_{j\text{ max}};$
r_T	Forward slope resistance, max	m Ω	0.028	0.028	0.027	$6300\text{ A} < I_T < 14000\text{ A}$
R_{thjc}	Thermal resistance, junction to case, max	$^\circ\text{C}/\text{W}$	0.0084	0.0076	0.0070	Direct current
R_{thjc-A}			0.0174	0.0157	0.0146	Double side cooled
R_{thjc-K}			0.0150	0.0143	0.0129	Anode side cooled Cathode side cooled

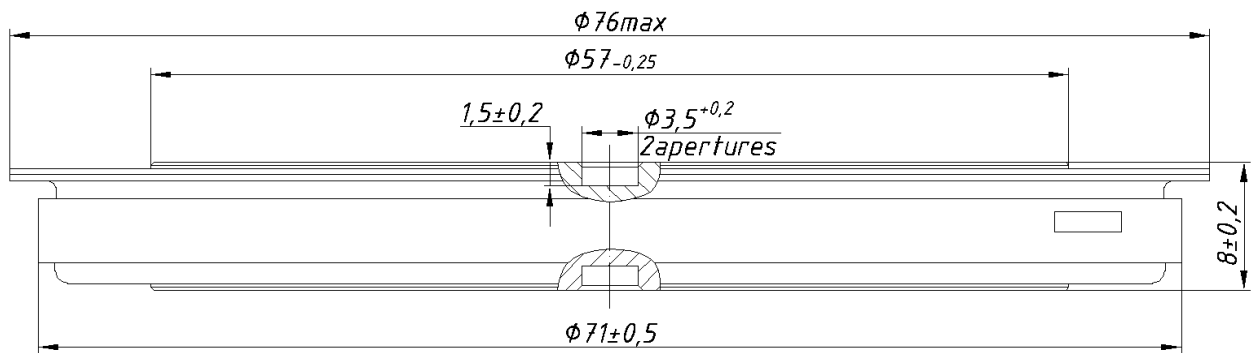

All dimensions in millimeters (inches)

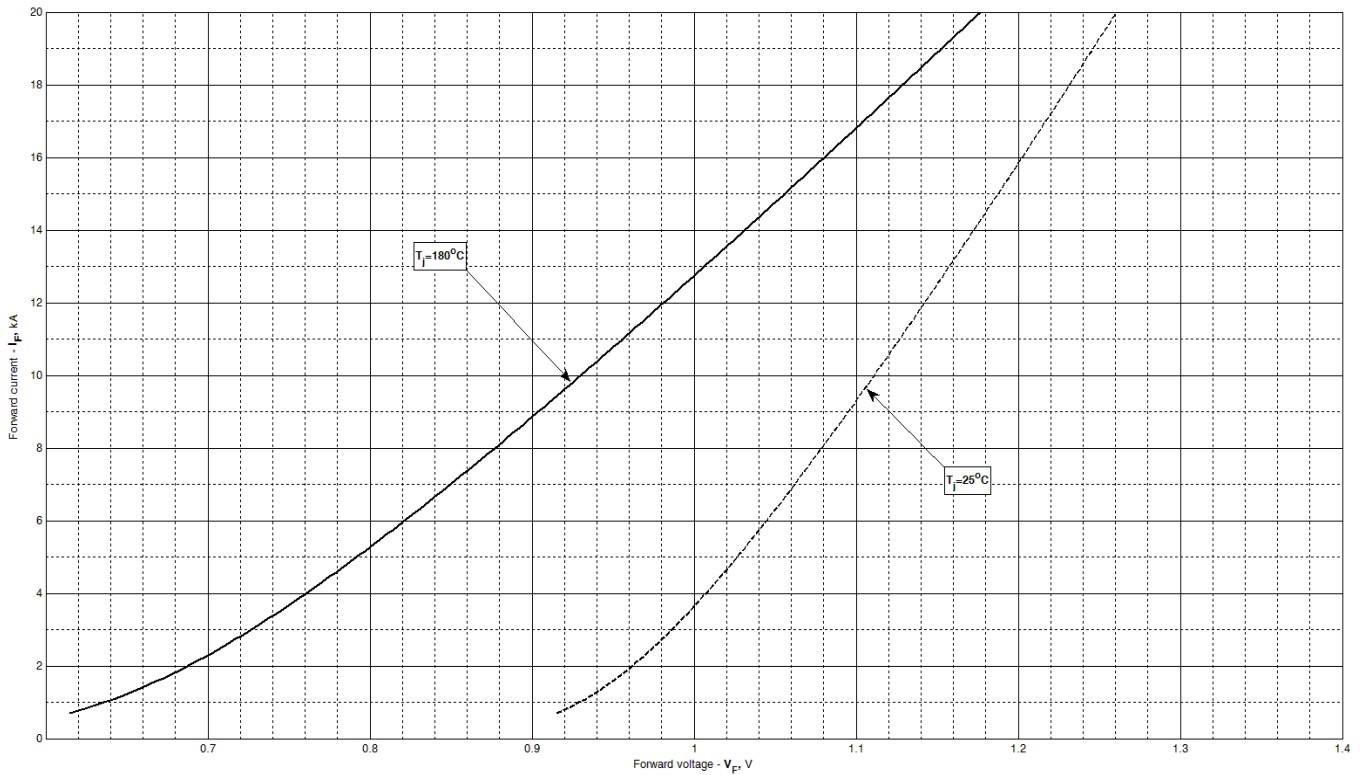

Fig 1 – Forward characteristics of Limit device

Analytical function for Forward characteristic:

$$V_F = A + B \cdot i_F + C \cdot \ln(i_F + 1) + D \cdot \sqrt{i_F}$$

	Coefficients for max curves	
	$T_j = 25^\circ\text{C}$	$T_j = T_{j \text{ max}}$
A	0.919038	0.618828
B	0.019250	0.031191
C	0.122752	0.186599
D	-0.093170	-0.141630

Forward characteristic model (see Fig. 1).

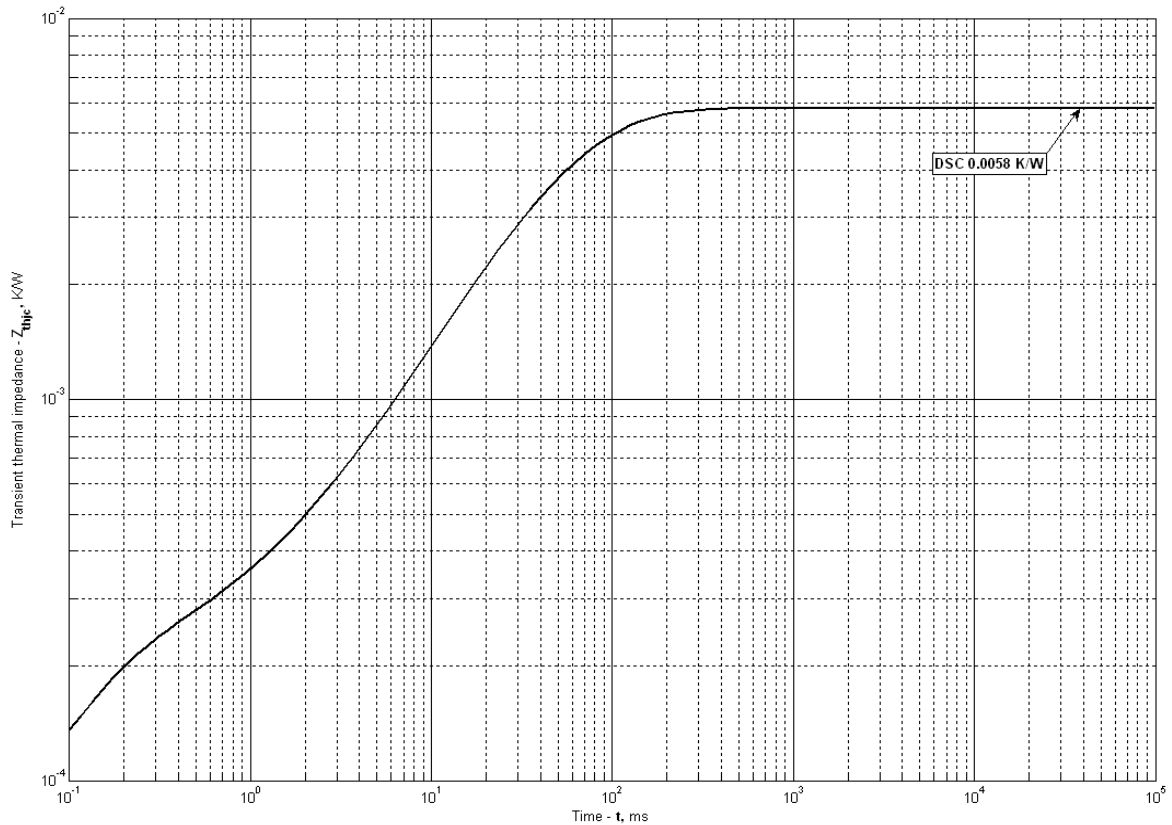

Fig 2 – Transient thermal impedance

Analytical function for Transient thermal impedance junction to case Z_{thjc} for DC:

$$Z_{thjc} = \sum_{i=1}^n R_i \left(1 - e^{-\frac{t}{\tau_i}} \right)$$

Where $i = 1$ to n , n is the number of terms in the series.

t = Duration of heating pulse in seconds.

Z_{thjc} = Thermal resistance at time t .

R_i = Amplitude of p_{th} term.

τ_i = Time constant of r_{th} term.

DC Double side cooled

i	1	2	3	4	5	6
R_i , K/W	0.001435	0.003586	0.0005253	0.00004082	0.00004206	0.0001706
τ_i , s	0.08662	0.04524	0.01461	0.00155	0.000286	0.0001009

Transient thermal impedance junction to case Z_{thjc} model (see Fig. 2)

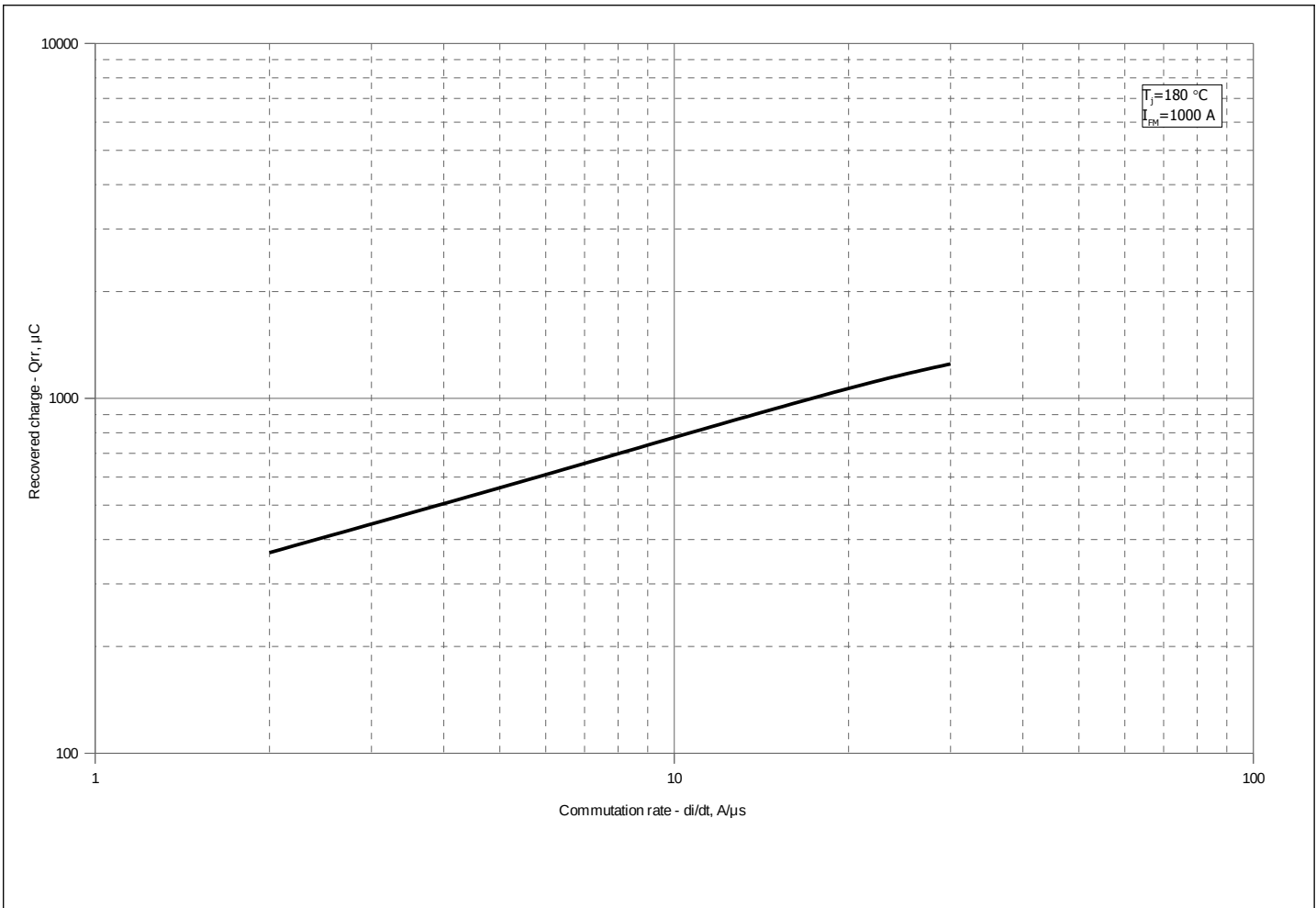

Fig 3 - Recovered charge, Q_{rr}

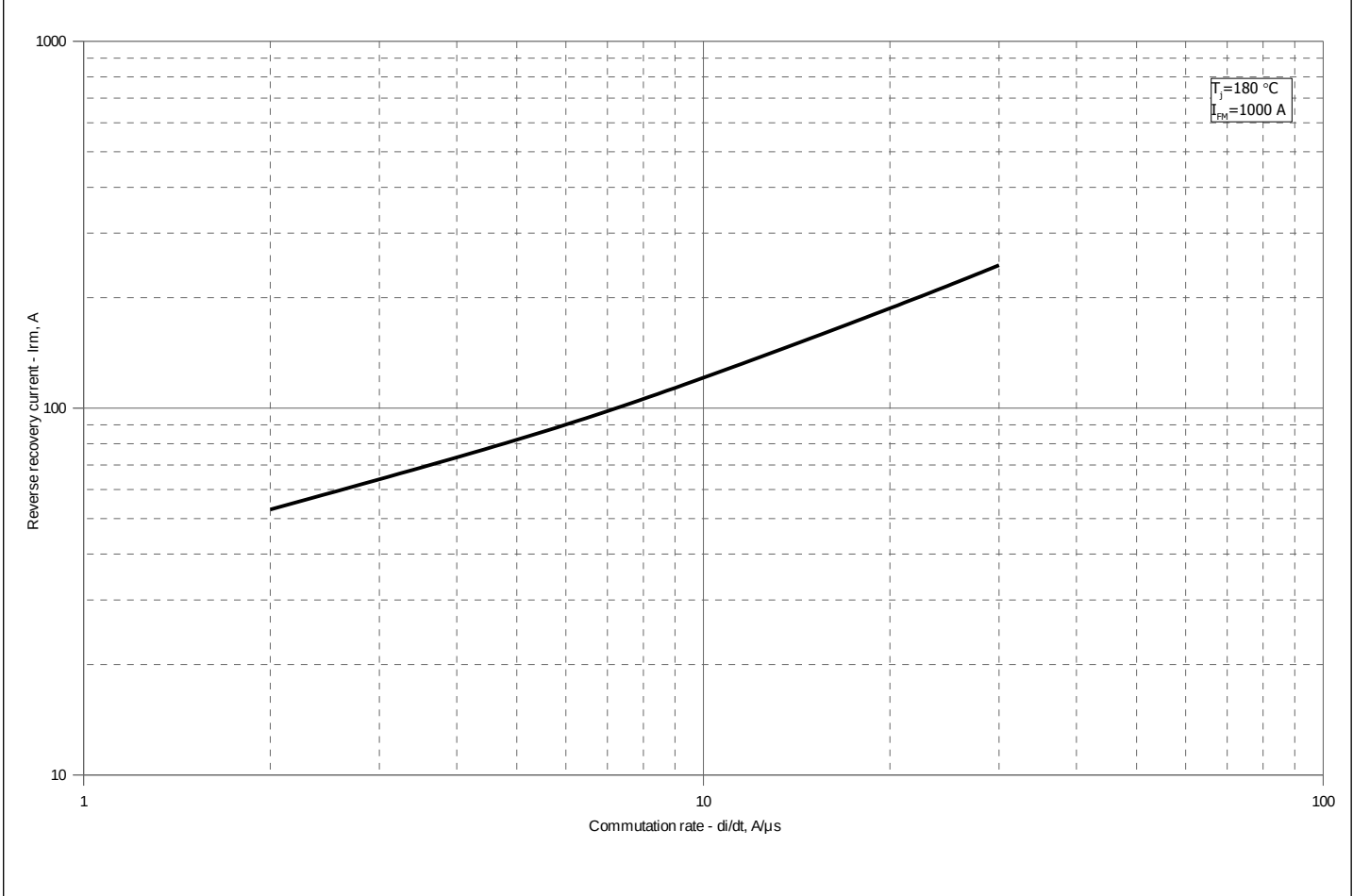

Fig 4 – Peak reverse recovery current, I_{rm}

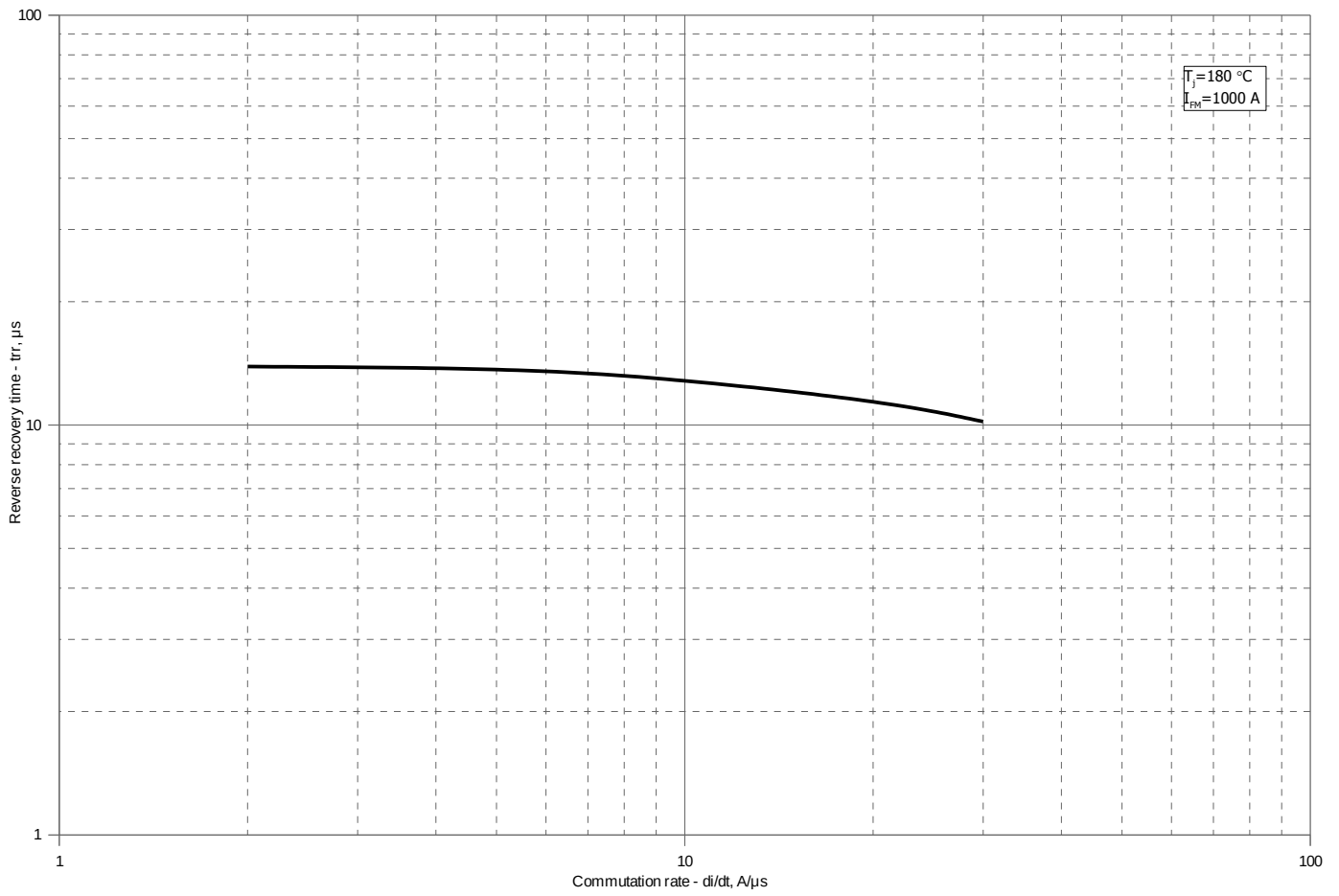

Fig 5 – Maximum recovery time, t_{rr} (linear)

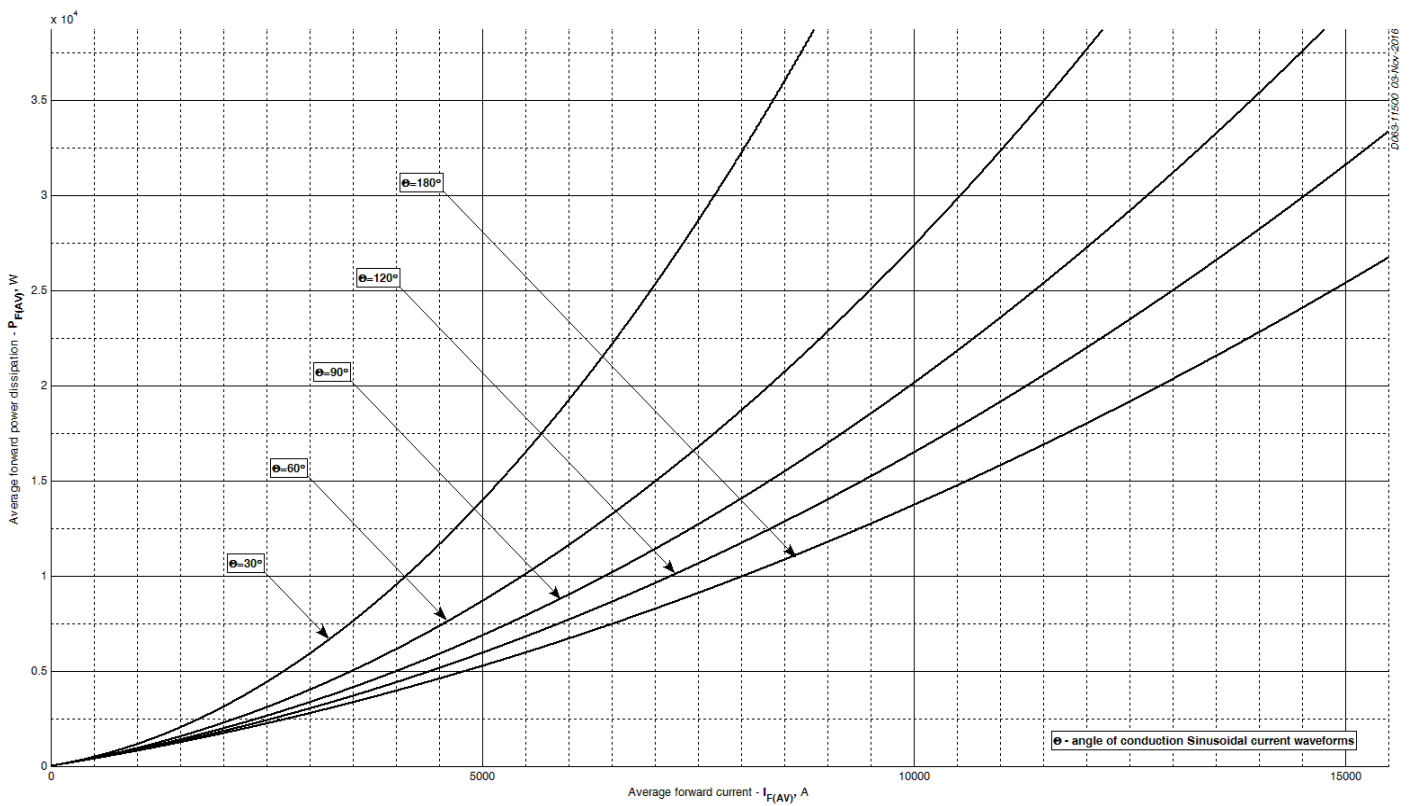

Fig 6 – Mean forward power dissipation P_{FAV} vs. Mean forward current I_{FAV} for sinusoidal current waveforms at different conduction angles ($f=50\text{Hz}$, DSC)

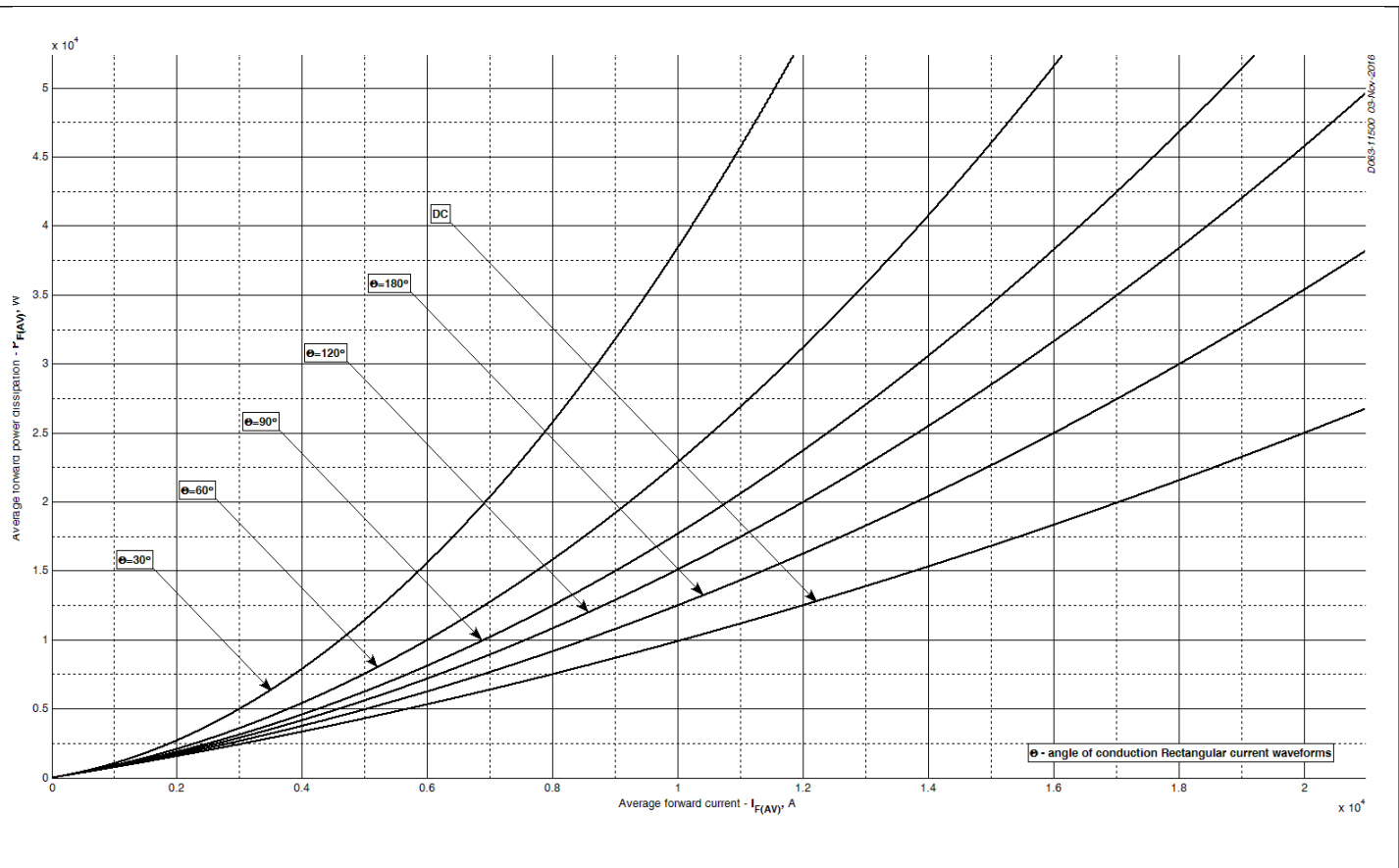

Fig 7 – Mean forward power dissipation P_{FAV} vs. Mean forward current I_{FAV} for rectangular current waveforms at different conduction angles and for DC (f=50Hz, DSC)

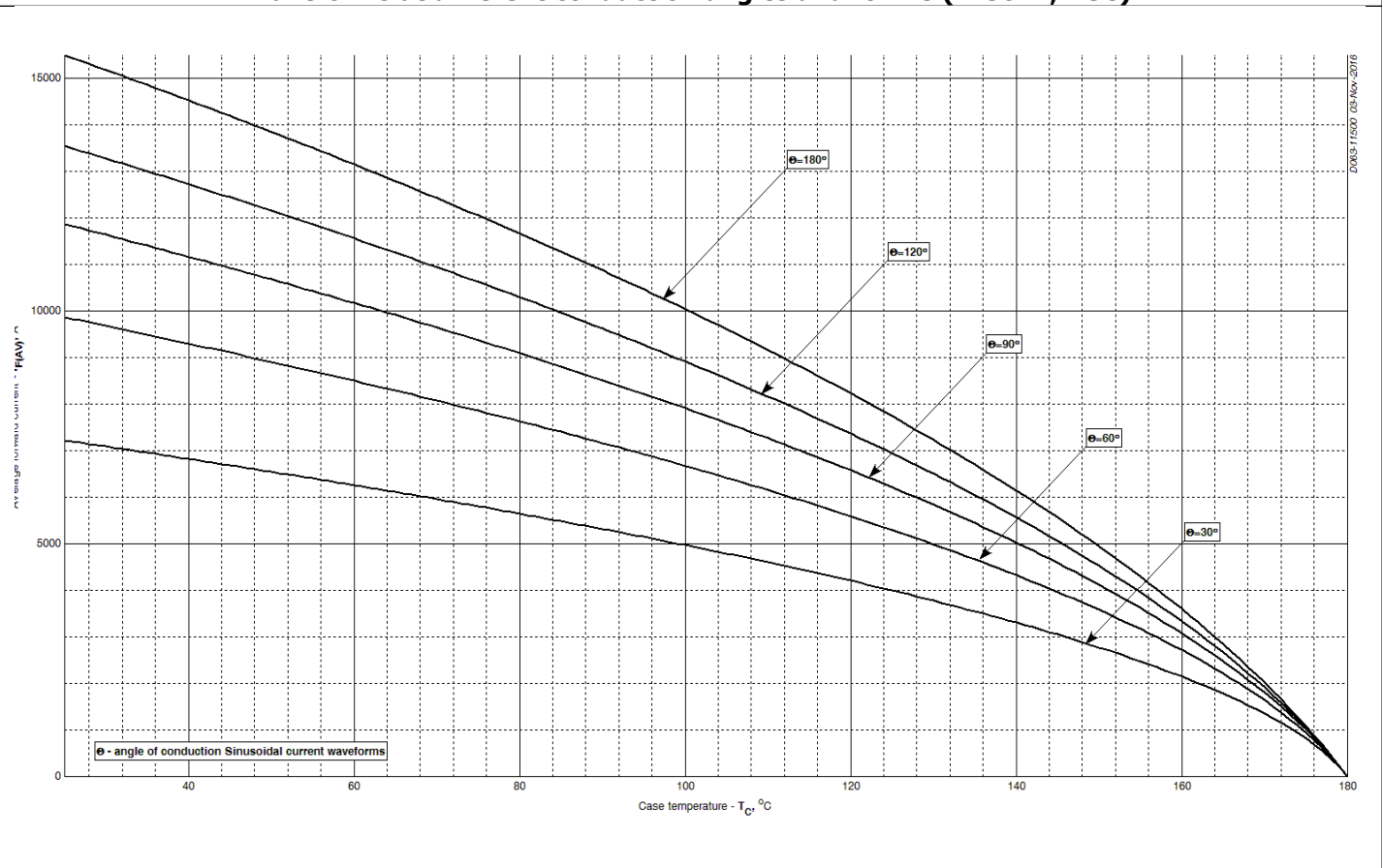

Fig 8 - Mean forward current I_{FAV} vs. Case temperature T_C for sinusoidal current waveforms at different conduction angles (f=50Hz, DSC)

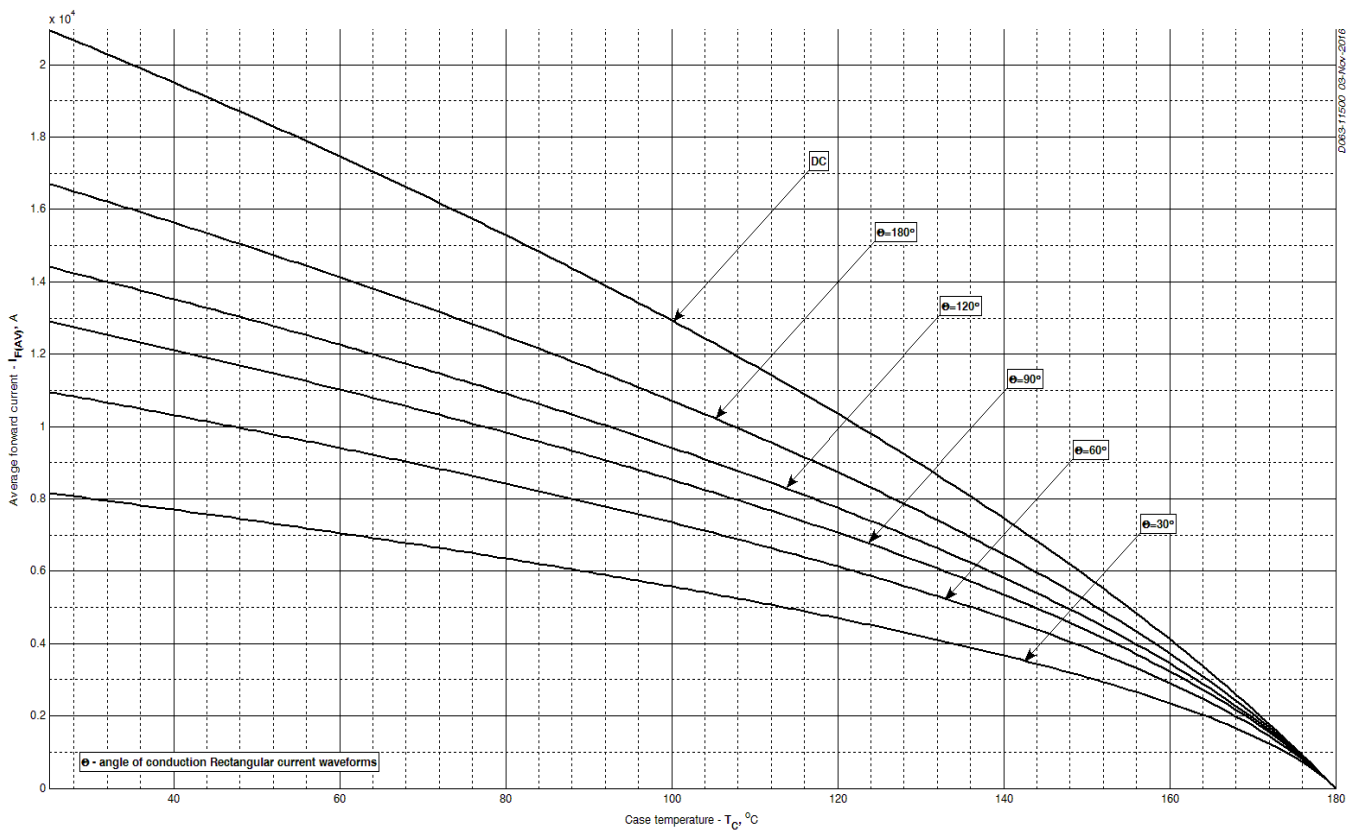

Fig 9 – Mean forward current I_{FAV} vs. Case temperature T_c for rectangular current waveforms at different conduction angles and for DC ($f=50Hz$, DSC)

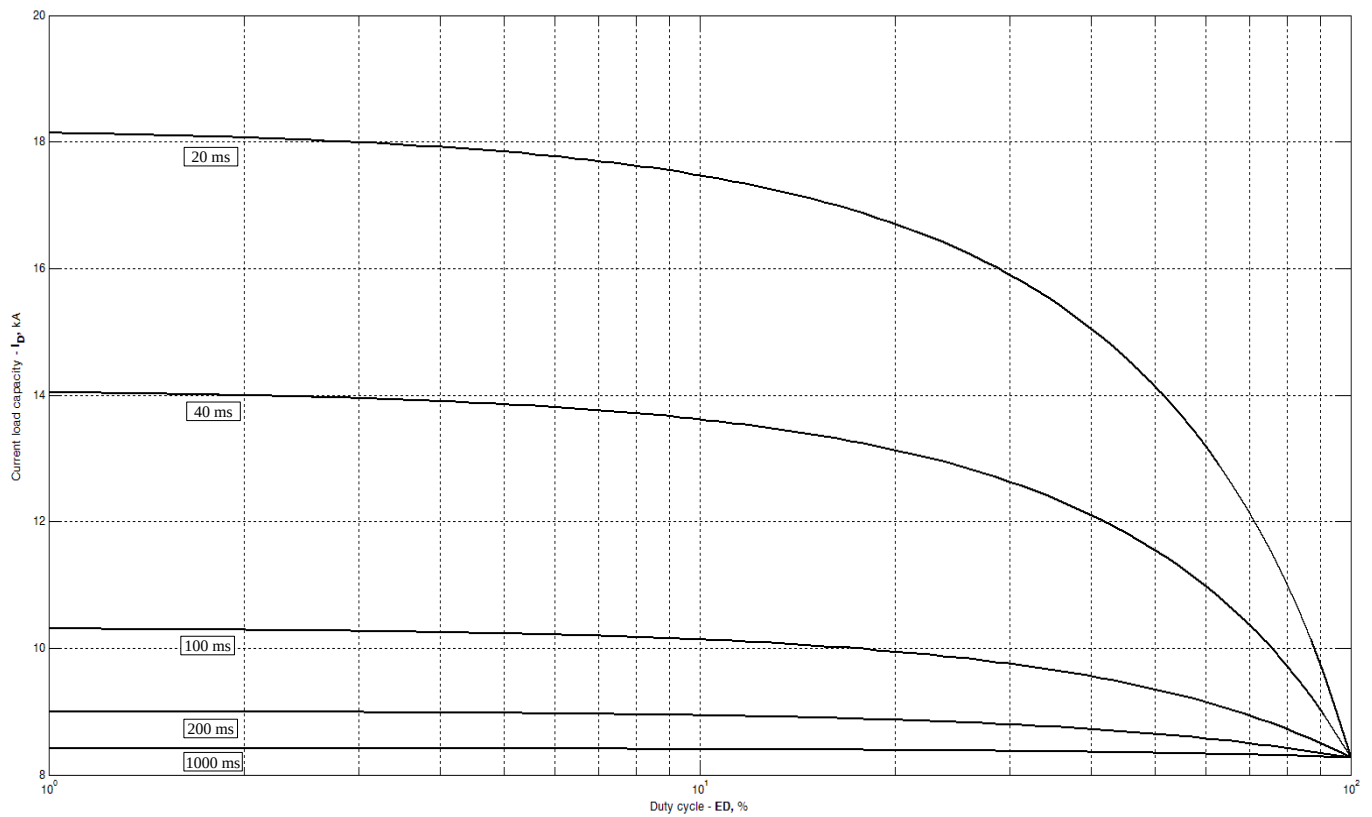
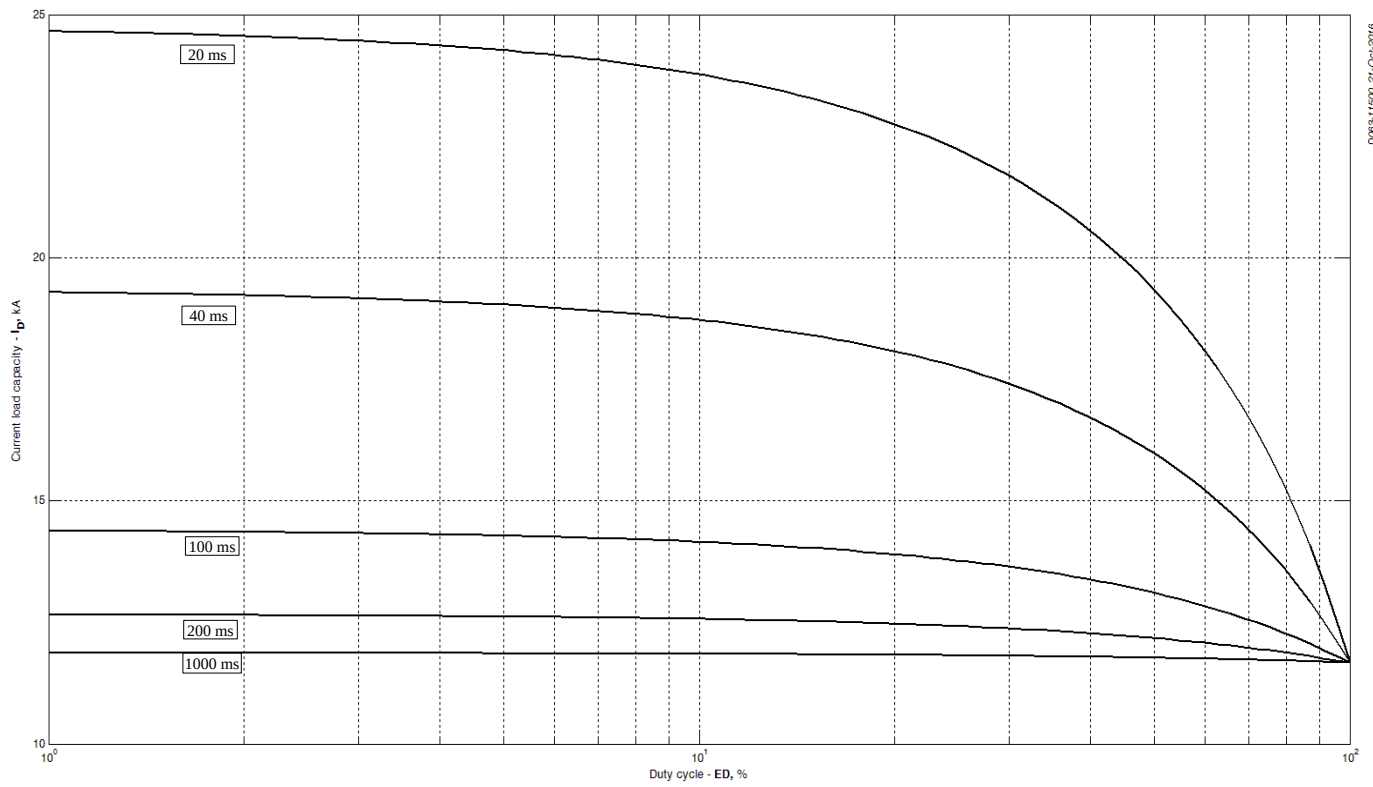
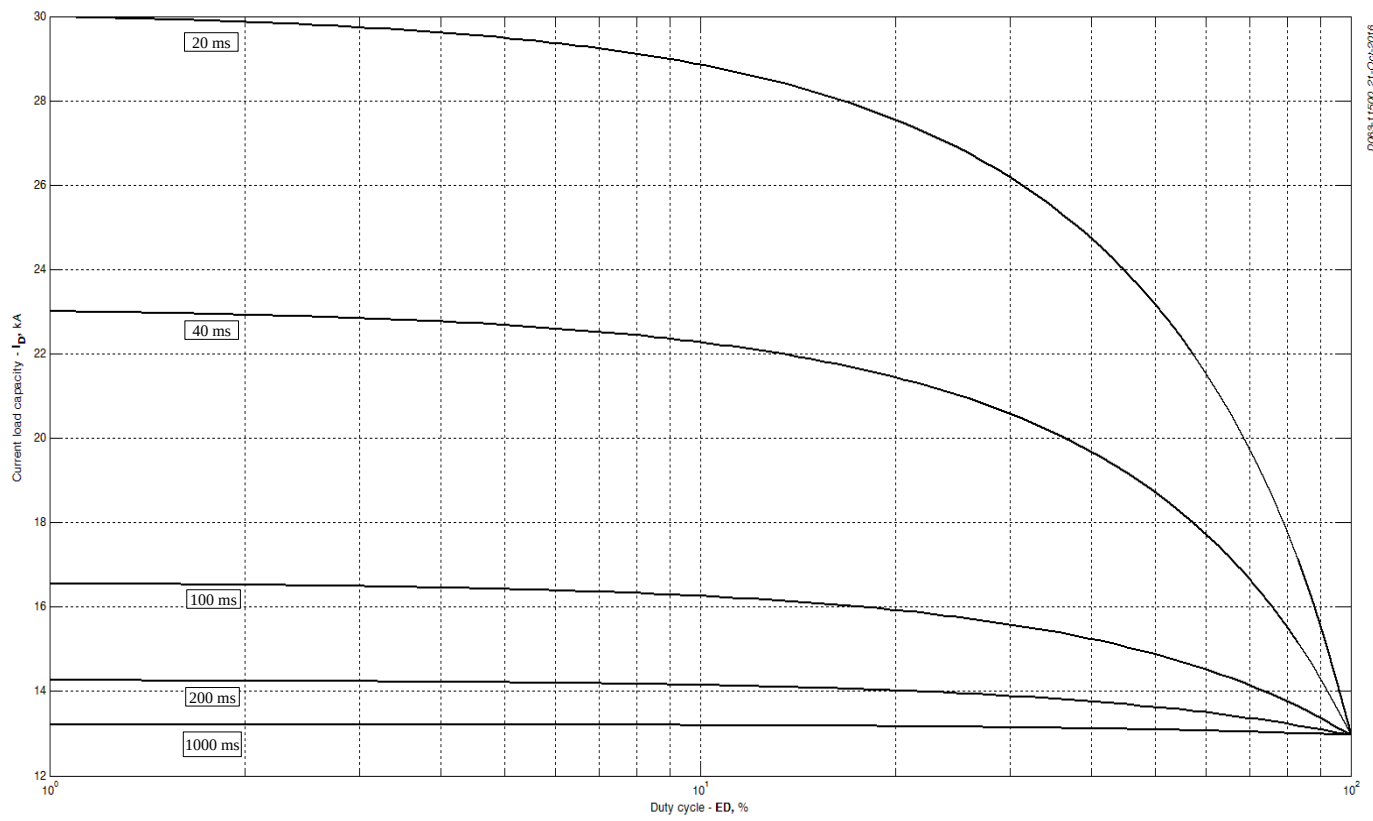

Fig 10 – Current load capability ($f=1000$ Hz, square wave, $T_c = 40^{\circ}C$)



D063-11500_21-Oct-2016

Fig 11 – Current load capability (f=1000 Hz, square wave, T_c = 60 °C)



D063-11500_21-Oct-2016

Fig 12 – Current load capability (f=1000 Hz, square wave, T_c = 70 °C)

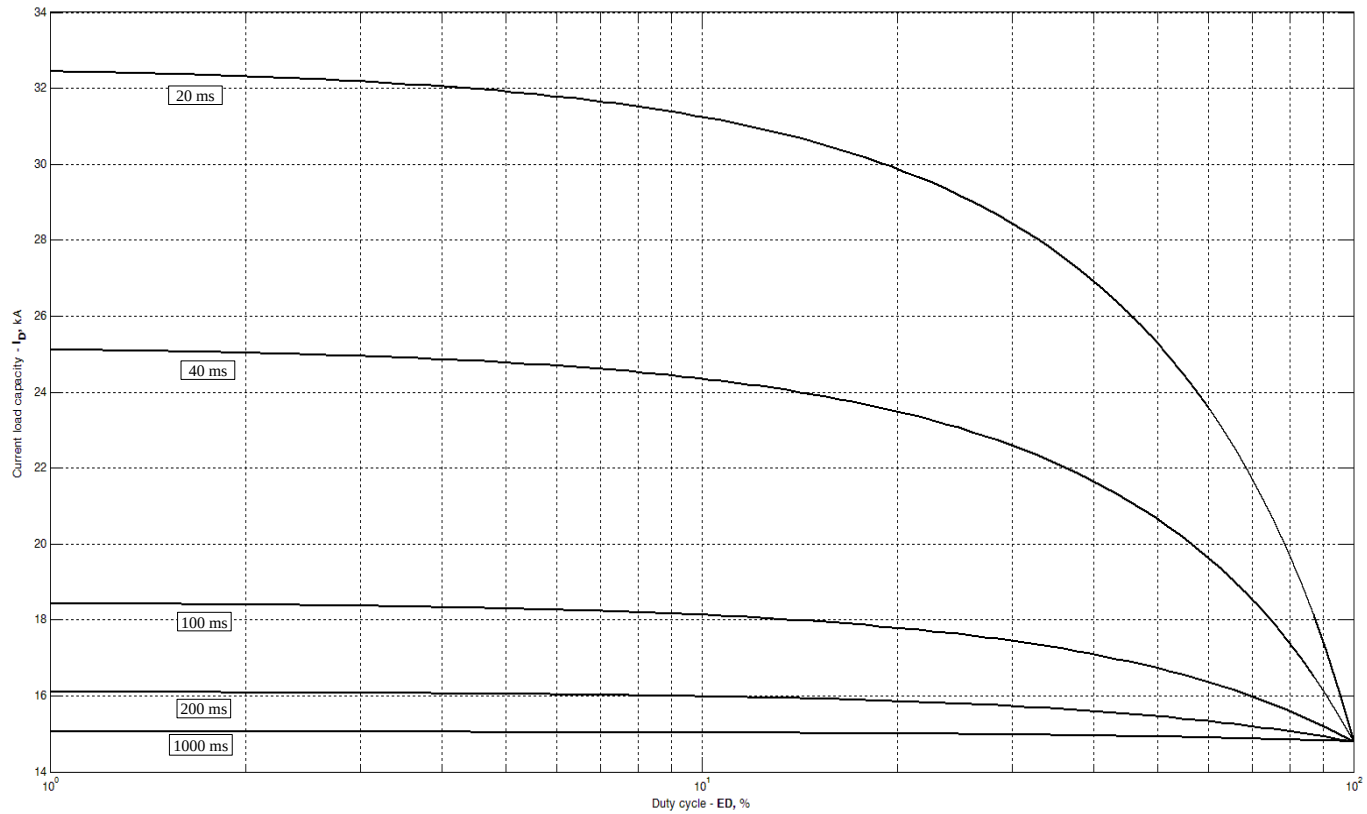

Fig 13 – Current load capability (f=1000 Hz, square wave, $T_c = 80\text{ }^\circ\text{C}$)

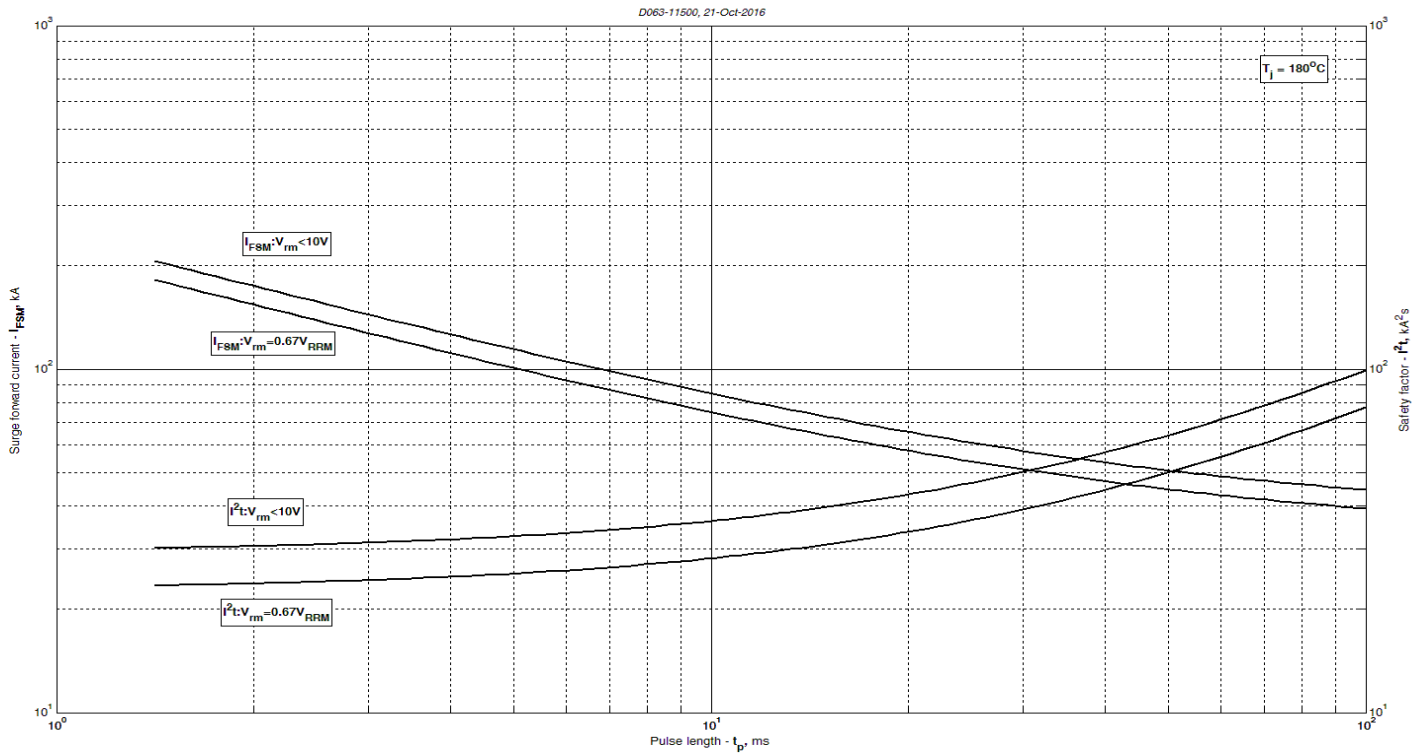

Fig 14 – Maximum surge and I^2t ratings

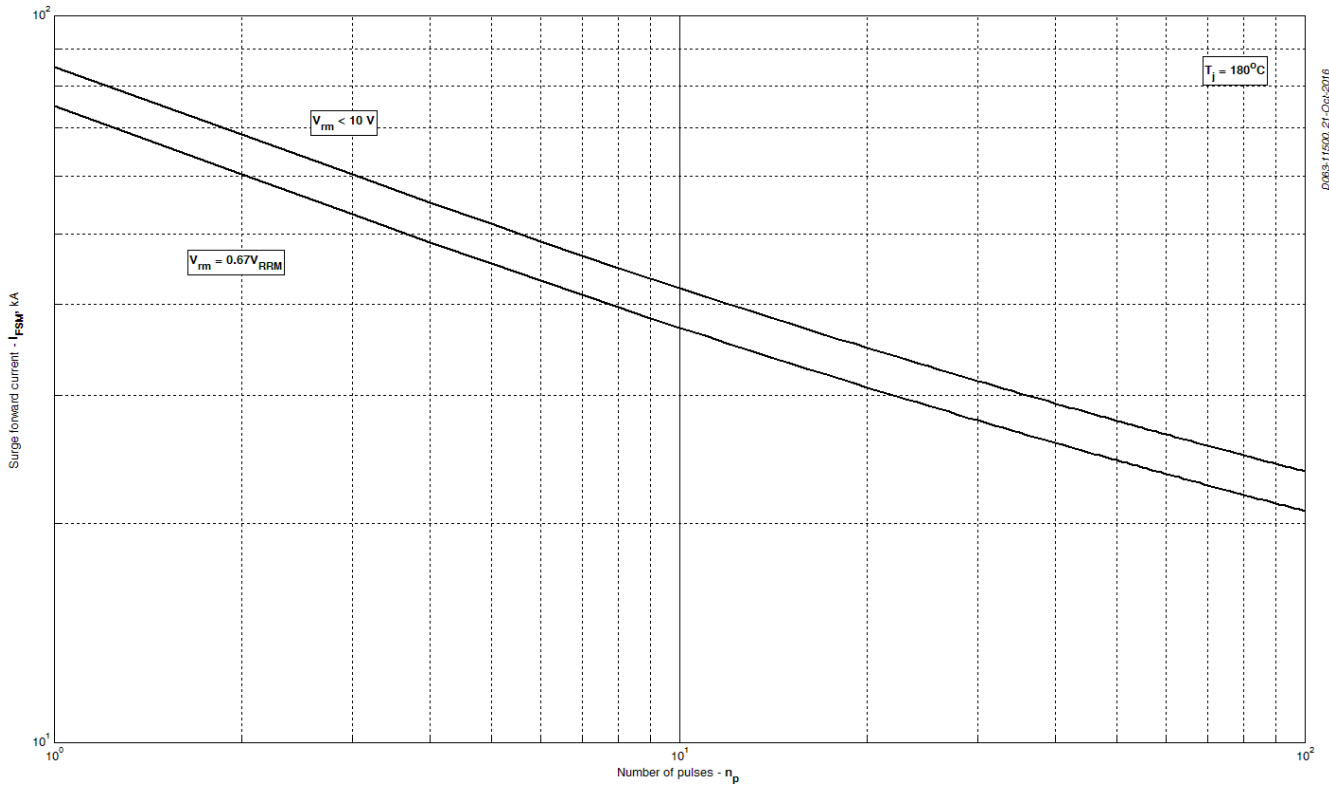

Fig 15 – Maximum surge ratings

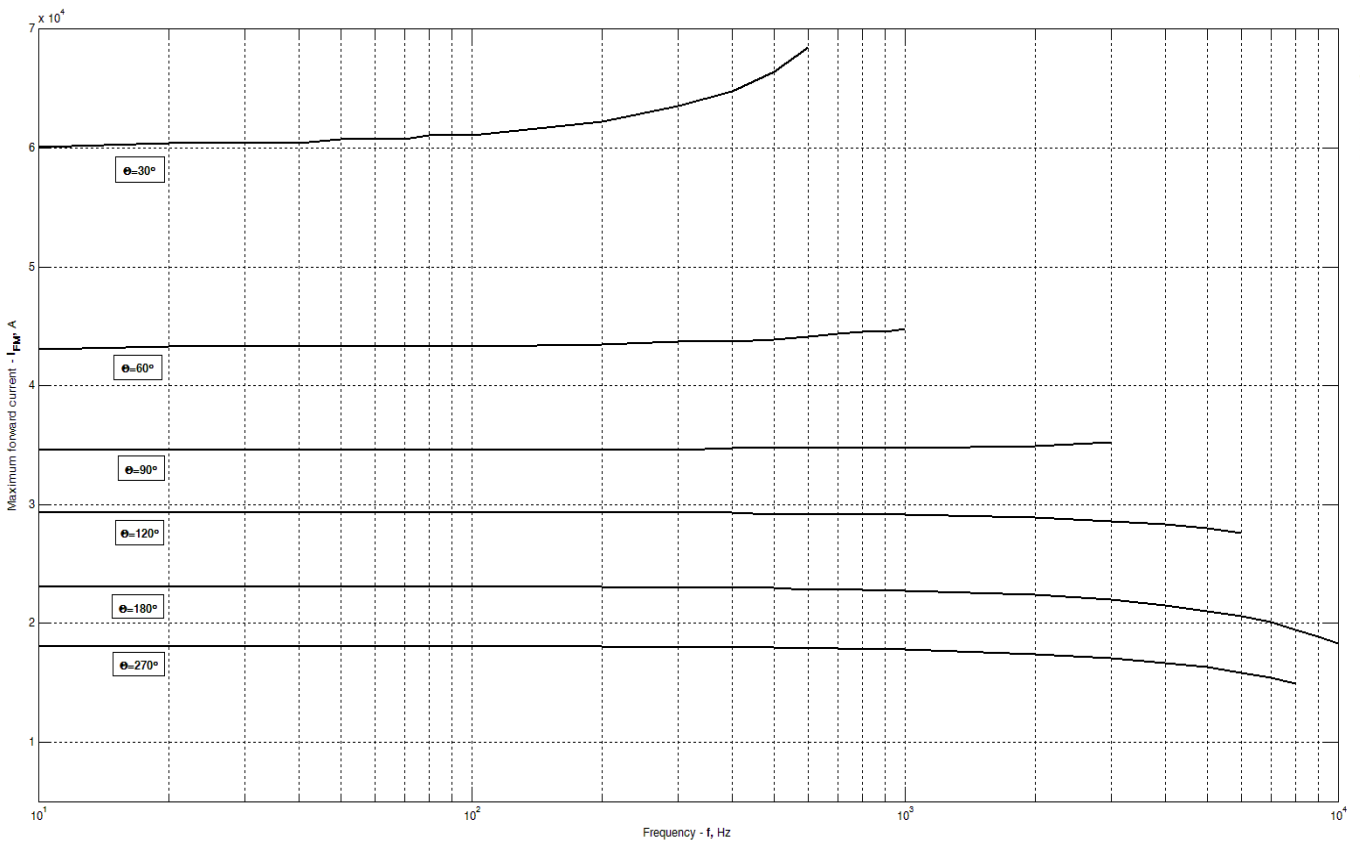
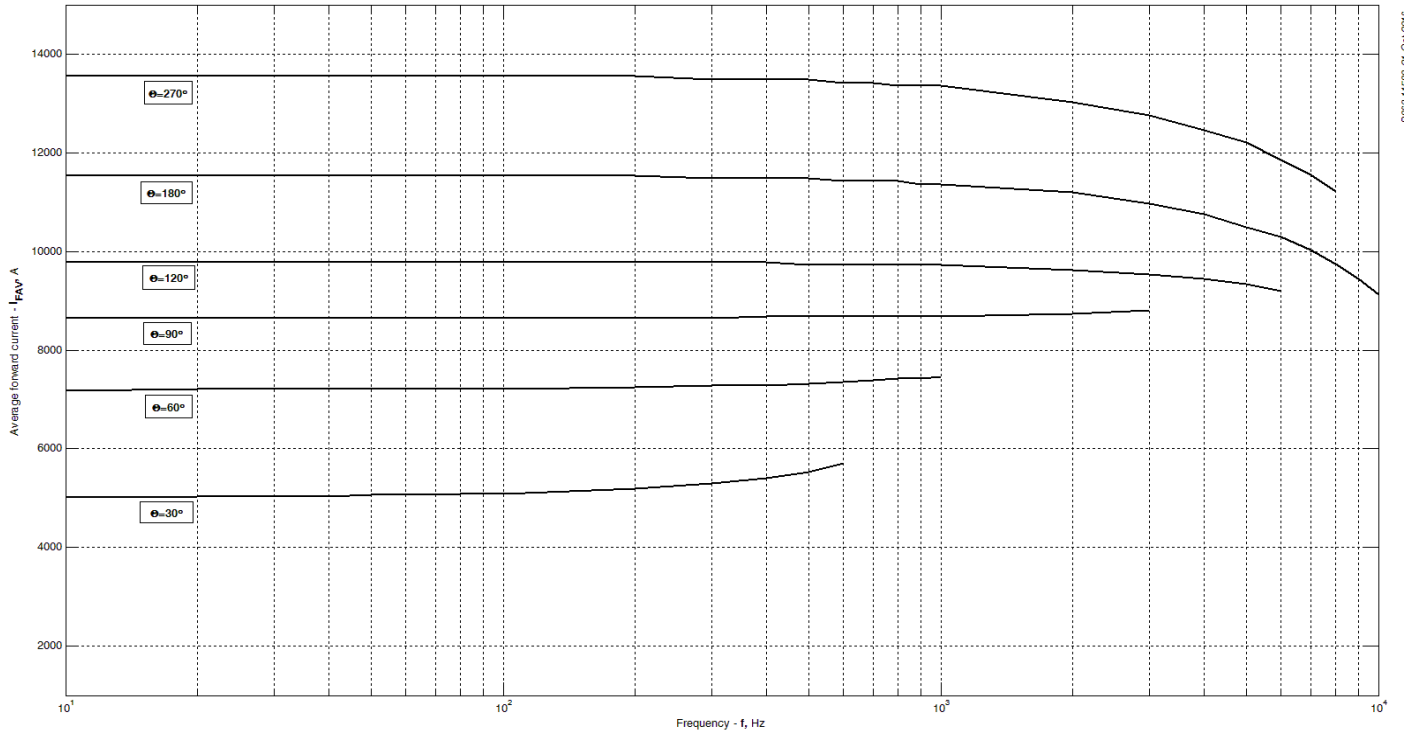

Fig 16 –Maximum forward current vs. frequency, trapezoid waveform, T_C=85 °C, di_F/dt=±500 A/μs, V_R=100 V



**Fig 17 –Average forward current vs. frequency, trapezoid waveform,
 $T_c=85^\circ\text{C}$, $di_F/dt=\pm 500\text{ A}/\mu\text{s}$, $V_R=100\text{ V}$**