

Optimum power handling
 Low on-state and switching losses
 Designed for traction and industrial applications

Rectifier Stud Diode Type D161-250X-18

Mean on-state current								I_{FAV}		250 A							
Repetitive peak reverse voltage								V_{RRM}		300 ÷ 1800V							
V_{RRM} , V	300	400	500	600	700	800	900	1000	1100	1200	1300	1400	1500	1600	1800		
Voltage code	3	4	5	6	7	8	9	10	11	12	13	14	15	16	18		
T_j , °C	- 60 ÷ 190																

MAXIMUM ALLOWABLE RATINGS

Symbols and parameters		Units	Values	Test conditions	
ON-STATE					
I_{FAV}	Average forward current	A	250 376	$T_c=150\text{ °C};$ $T_c=120\text{ °C};$ 180° half-sine wave; 50 Hz	
I_{FRMS}	RMS forward current	A	393	$T_c=150\text{ °C};$ 180° half-sine wave; 50 Hz	
I_{FSM}	Surge forward current	kA	7.0 8.5	$T_j=T_{j\max}$ $T_j=25\text{ °C}$	180° half-sine wave; $t_p=10\text{ ms};$ single pulse; $V_R=0\text{ V};$
			7.5 9.0	$T_j=T_{j\max}$ $T_j=25\text{ °C}$	180° half-sine wave; $t_p=8.3\text{ ms};$ single pulse; $V_R=0\text{ V};$
I^2t	Safety factor	$A^2s \cdot 10^3$	240 360	$T_j=T_{j\max}$ $T_j=25\text{ °C}$	180° half-sine wave; $t_p=10\text{ ms};$ single pulse; $V_R=0\text{ V};$
			230 330	$T_j=T_{j\max}$ $T_j=25\text{ °C}$	180° half-sine wave; $t_p=8.3\text{ ms};$ single pulse; $V_R=0\text{ V};$
BLOCKING					
V_{RRM}	Repetitive peak reverse voltages	V	300÷1800	$T_{j\min} < T_j < T_{j\max};$ 180° half-sine wave; 50 Hz;	
V_{RSM}	Non-repetitive peak reverse voltages	V	350÷2080	$T_{j\min} < T_j < T_{j\max};$ 180° half-sine wave; single pulse;	
V_R	Reverse continuous voltages	V	$0.6 \cdot V_{RRM}$	$T_j=T_{j\max};$	
THERMAL					
T_{stg}	Storage temperature	°C	- 60 ÷ 50		
T_j	Operating junction temperature	°C	- 60 ÷ 190		
MECHANICAL					
M	Tightening torque	Nm	20 ÷ 30		
a	Acceleration	m/s^2	100		

CHARACTERISTICS

Symbols and parameters		Units	Values	Conditions
ON-STATE				
V_{FM}	Peak forward voltage, max	V	1.35	$T_j=25\text{ }^\circ\text{C}; I_{FM}=785\text{ A}$
$V_{F(TO)}$	Forward threshold voltage, max	V	0.785	$T_j=T_{j\text{ max}};$
r_T	Forward slope resistance, max	m Ω	0.701	$0.5\pi I_{FAV} < I_T < 1.5\pi I_{FAV}$
BLOCKING				
I_{RRM}	Repetitive peak reverse current, max	mA	40	$T_j=T_{j\text{ max}};$ $V_R=V_{RRM}$
SWITCHING				
Q_{rr}	Total recovered charge, max	μC	900	$T_j=T_{j\text{ max}}; I_{TM}=250\text{ A};$
t_{rr}	Reverse recovery time, max	μs	18	$di_R/dt=-10\text{ A}/\mu\text{s};$
I_{rrM}	Peak reverse recovery current, max	A	100	$V_R=100\text{ V};$
THERMAL				
R_{thjc}	Thermal resistance, junction to case, max	$^\circ\text{C}/\text{W}$	0.130	Direct current
MECHANICAL				
w	Weight, max	g	240	
D_s	Surface creepage distance	mm (inch)	12.4 (4.882)	
D_a	Air strike distance	mm (inch)	12.4 (4.882)	

PART NUMBERING GUIDE

D	161	250	X	18	N
1	2	3	4	5	6

1. D — Rectifier Diode
2. Design version
3. Average forward current, A
4. Polarity: X – Cathode to Stud; Anode to Stud – no symbol
5. Voltage code
6. Ambient conditions: N – normal; T – tropical

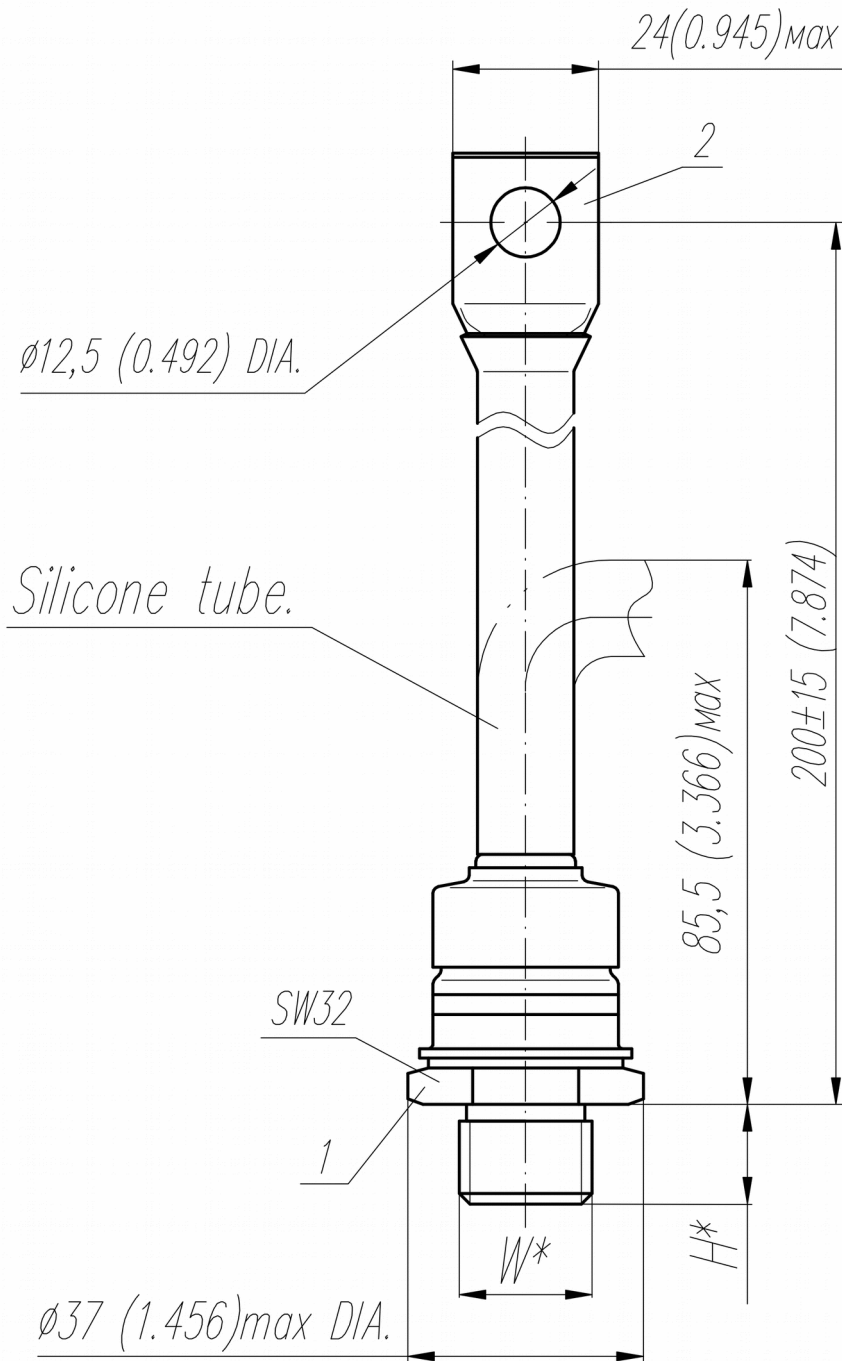

Type of screw	W	H
Metric Screw Type A (upon request)	M16x1,5 – 8g	13
Metric Screw Type B	M20x1,5 – 8g	15

Polarity		Example of code designation	Reference designation	Colors	
				Anode	Cathode
Reverse	Cathode to stud	D161-250X-18	▽	Black tube	-

All dimensions in millimeters (inches)

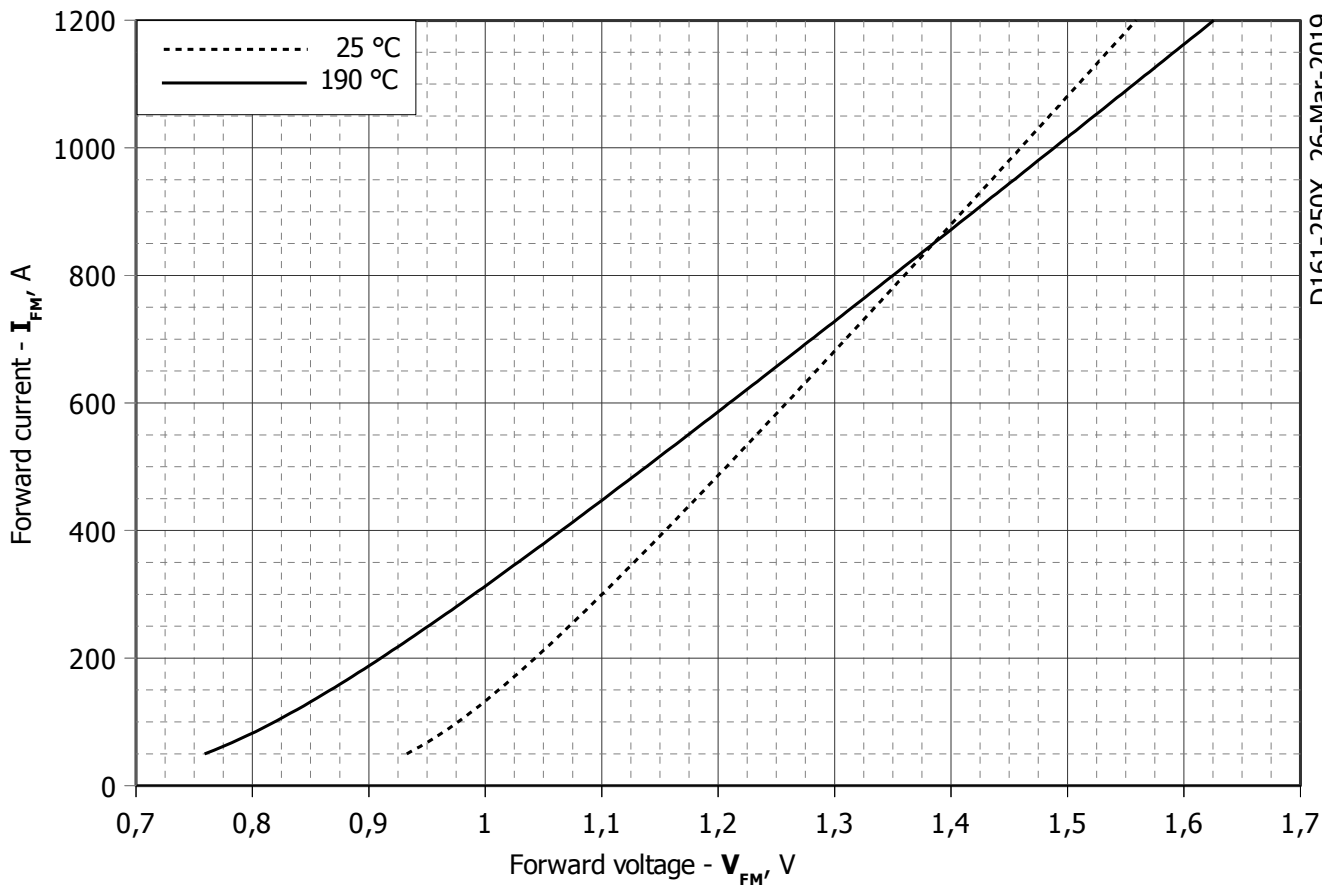

Fig 1 – Forward characteristics of Limit device

$$V_F = A + B \cdot i_F + C \cdot \ln(i_F + 1) + D \cdot \sqrt{i_F}$$

	Coefficients for max curves	
	$T_j = 25^\circ\text{C}$	$T_j = T_{j\text{max}}$
A	0,77187000	0,54916000
B	0,00049893	0,00067988
C	0,03913500	0,04932000
D	-0,00257380	-0,00256910

Forward characteristic model (see Fig. 1).

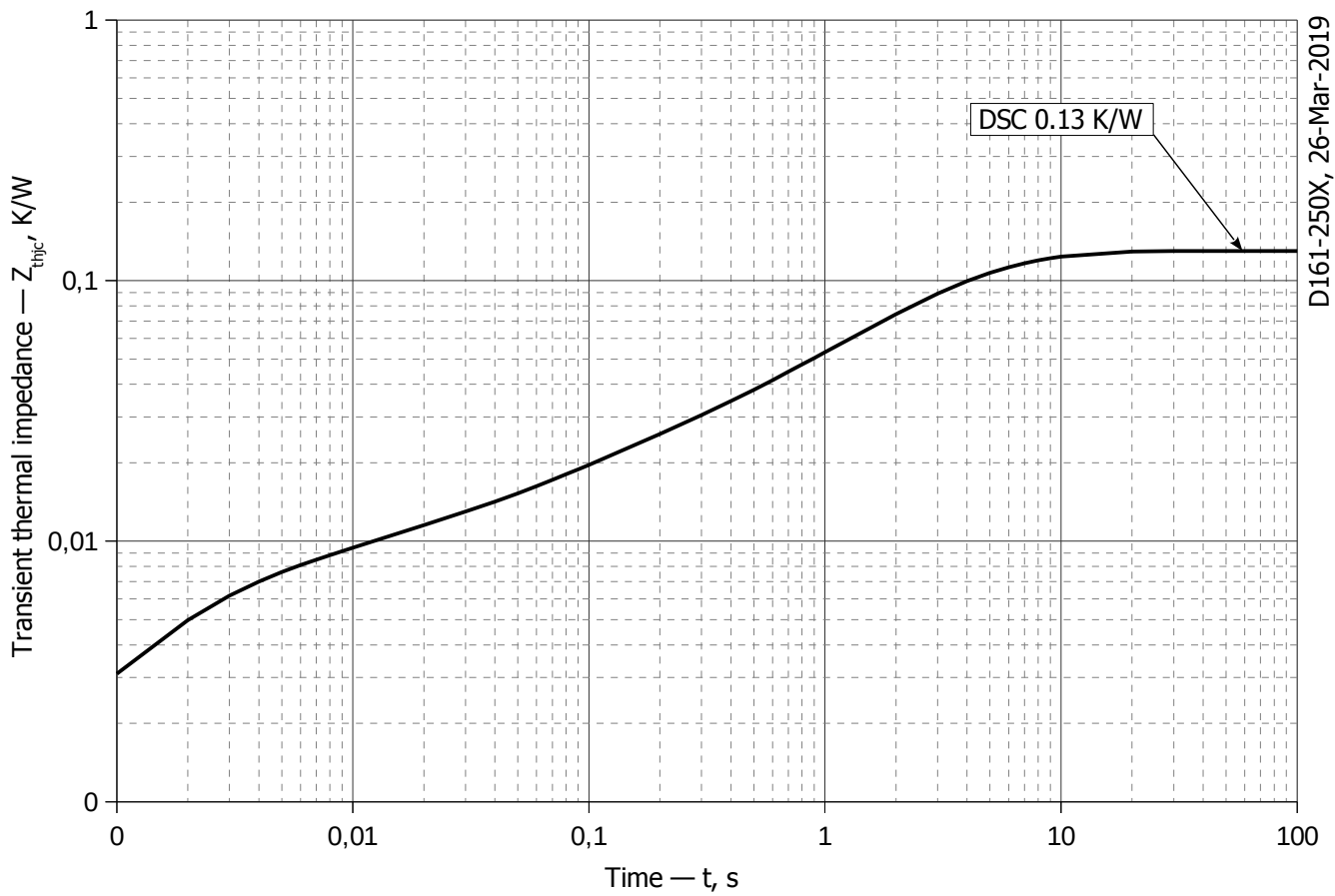

Fig 2 – Transient thermal impedance Z_{thjc} vs. time t

Analytical function for Transient thermal impedance junction to case Z_{thjc} for DC:

$$Z_{thjc} = \sum_{i=1}^n R_i \left(1 - e^{-\frac{t}{\tau_i}} \right)$$

Where $i = 1$ to n , n is the number of terms in the series.

t = Duration of heating pulse in seconds.

Z_{thjc} = Thermal resistance at time t .

R_i = Amplitude of p_{th} term.

τ_i = Time constant of r_{th} term.

DC

i	1	2	3	4	5	6
R_i, K/W	0.05504	0.0516	0.007369	0.006977	0.003512	0.005502
τ_i, s	4.409	2.183	0.3382	0.07307	0.008189	0.001615

Transient thermal impedance junction to case Z_{thjc} model (see Fig. 2)

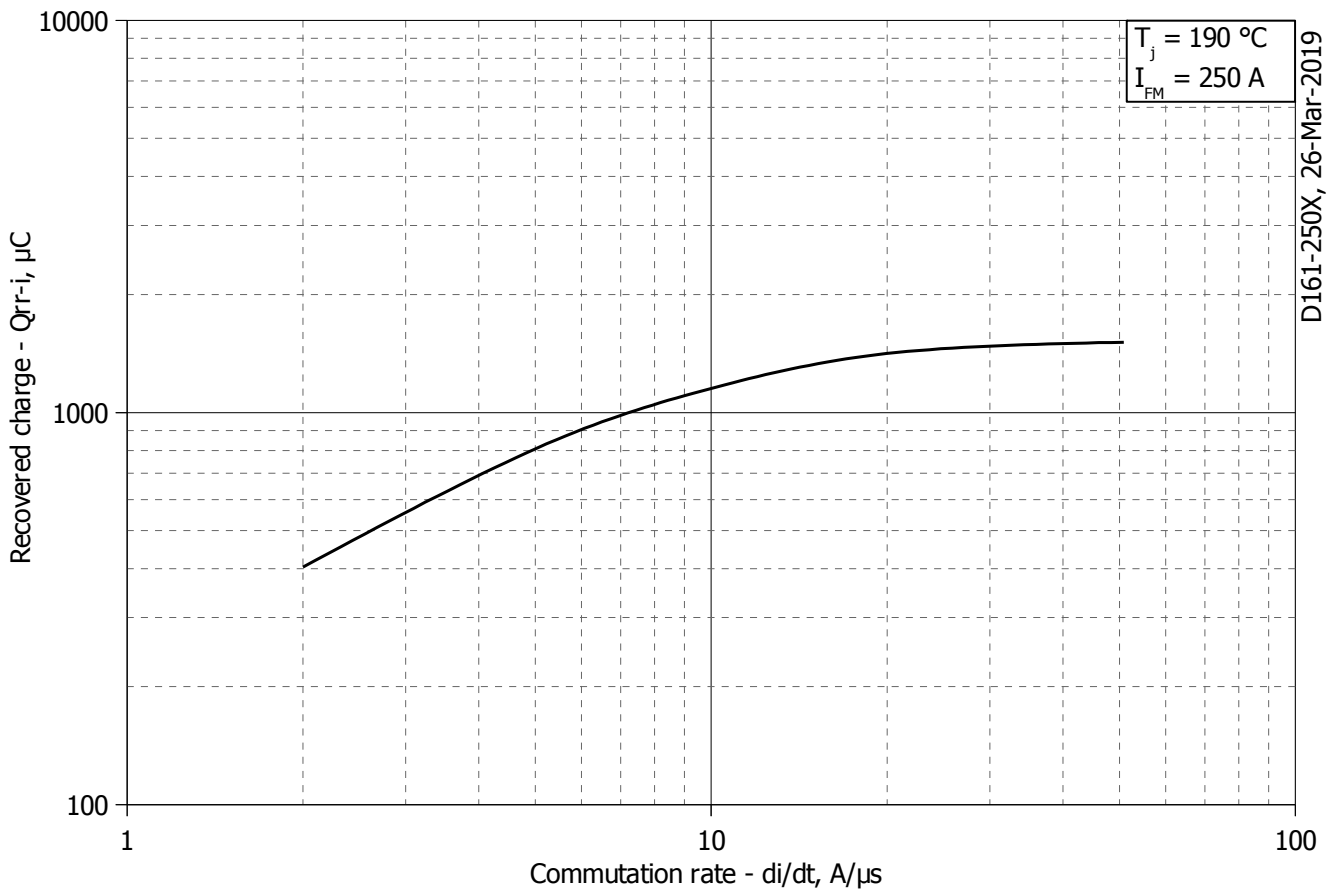

Fig 3 – Maximum recovered charge Q_{rr-i} (integral) vs. commutation rate di_R/dt

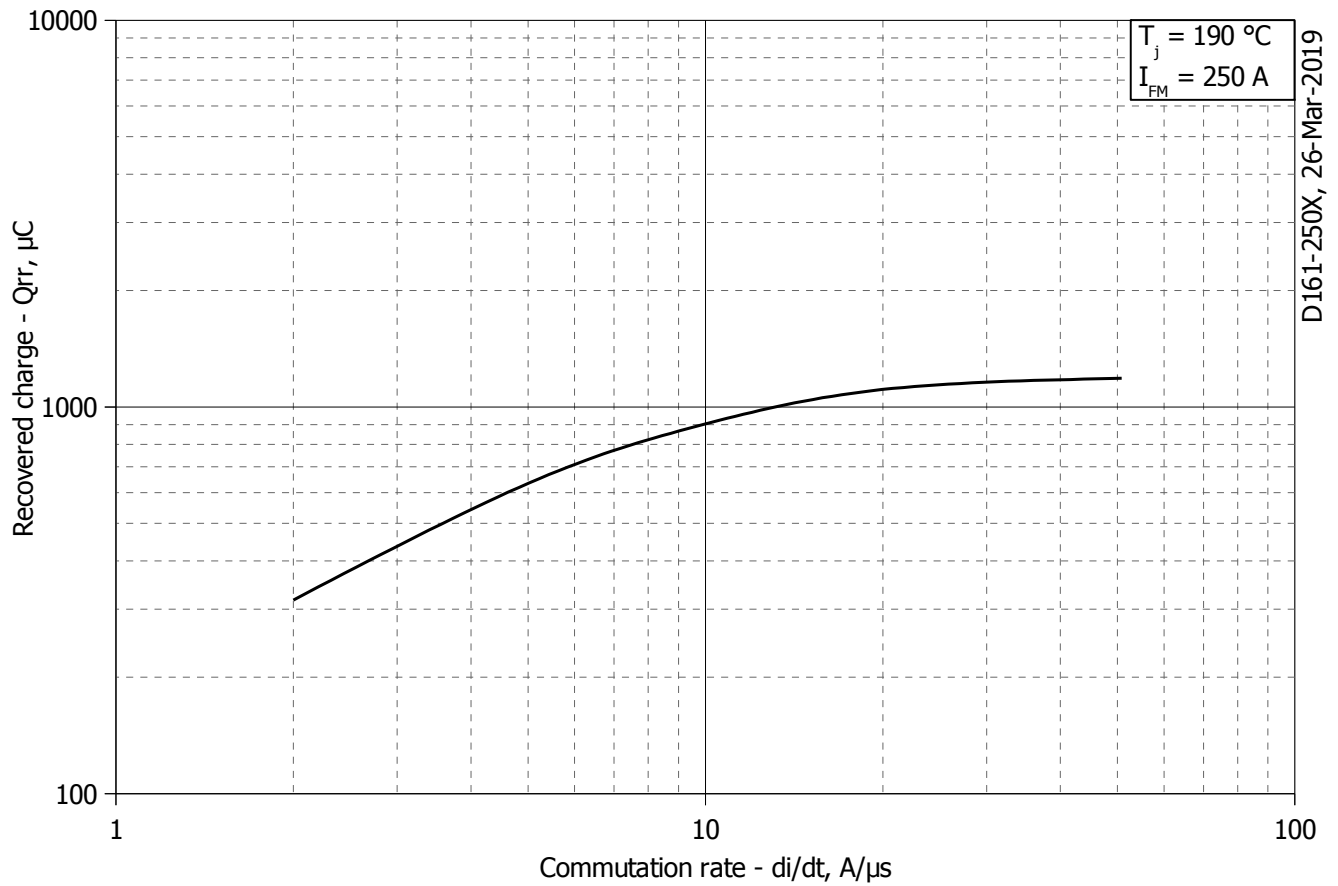
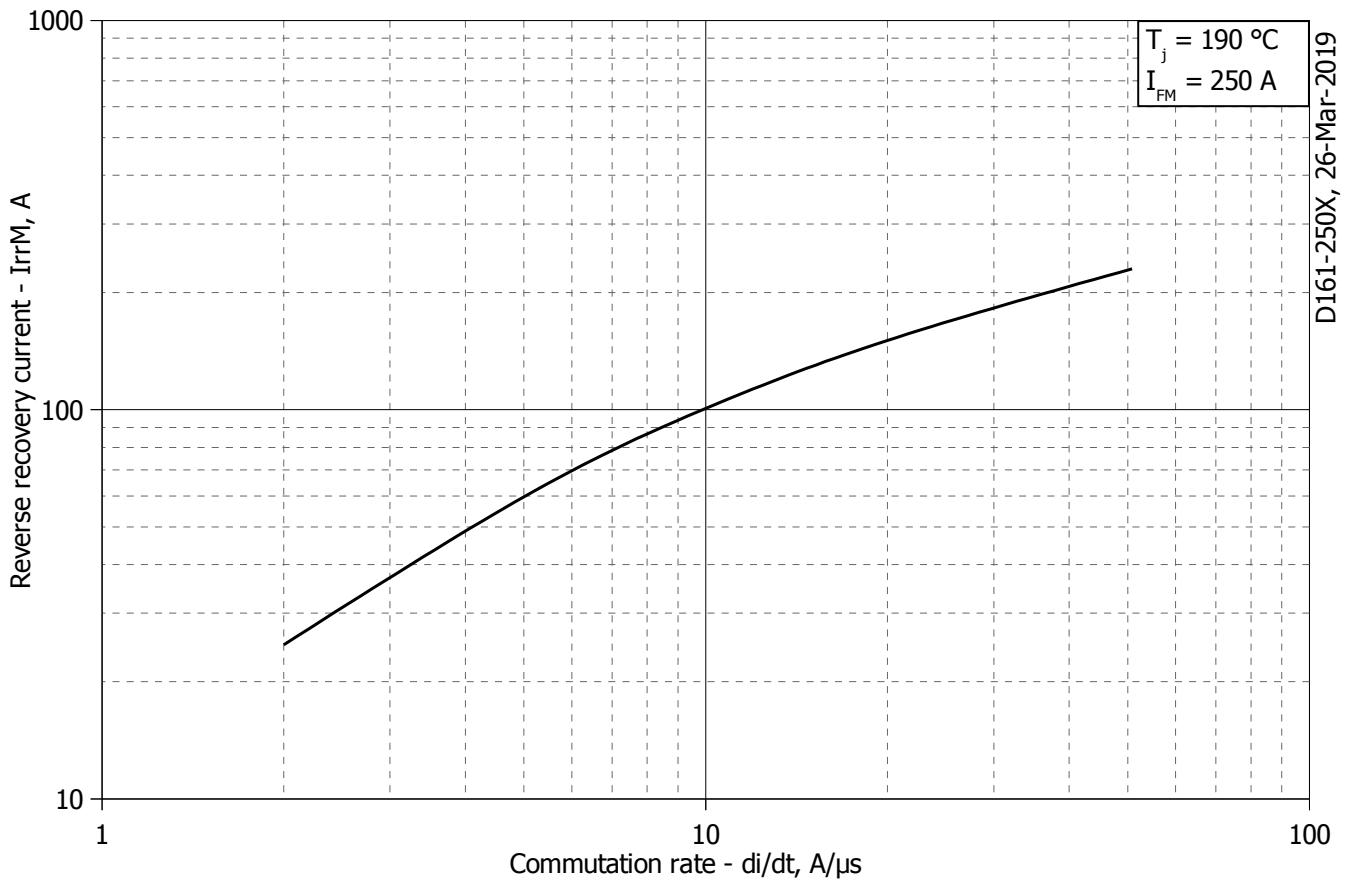
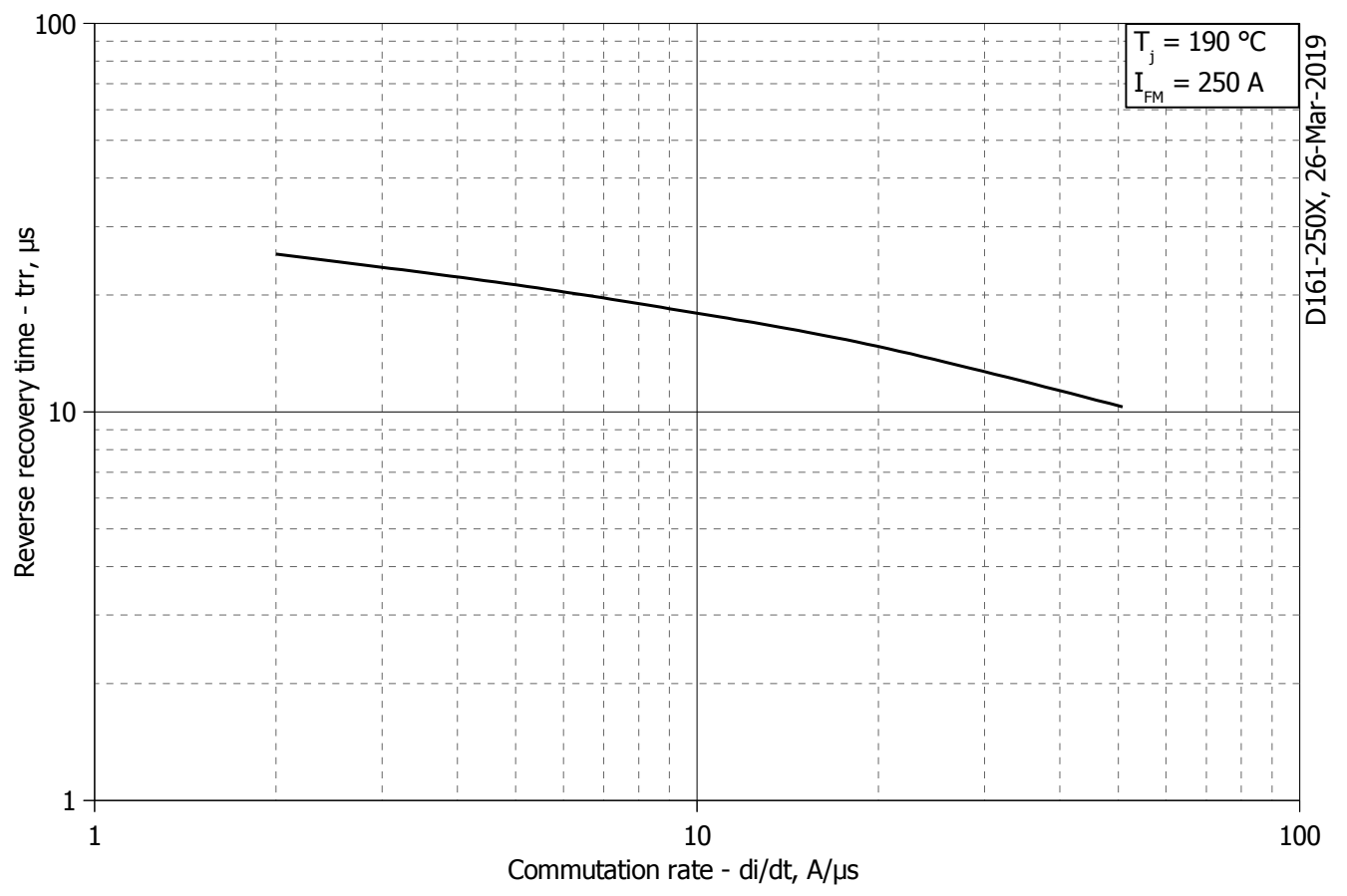

Fig 4 – Maximum recovered charge Q_{rr} vs. commutation rate di_R/dt (25% chord)



D161-250X, 26-Mar-2019

Fig 5 – Maximum reverse recovery current I_{rrM} vs. commutation rate di_R/dt



D161-250X, 26-Mar-2019

Fig 6 – Maximum recovery time t_{rr} vs. commutation rate di_R/dt (25% chord)

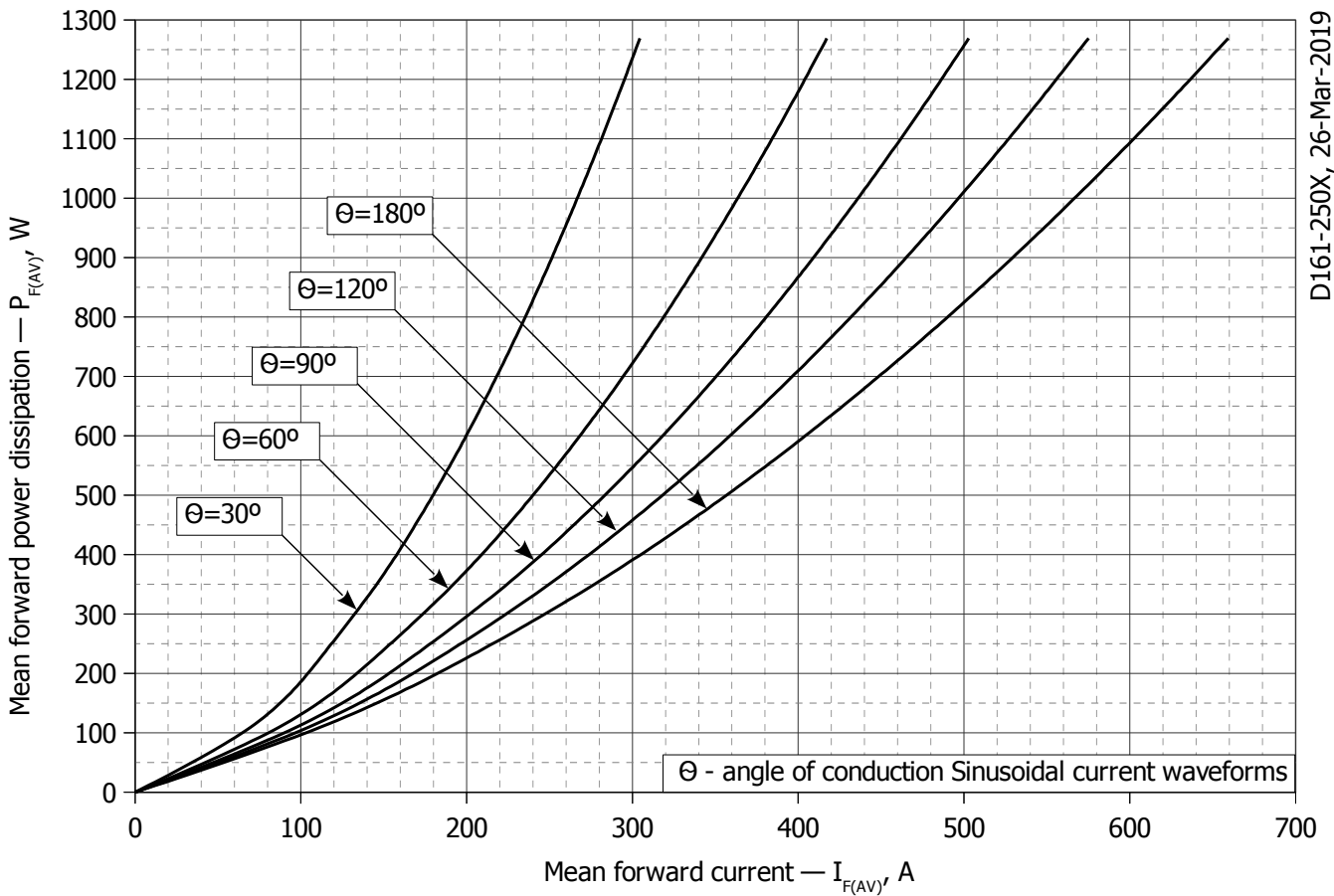

Fig. 7 - Mean forward power dissipation P_{FAV} vs. mean forward current I_{FAV} for sinusoidal current waveforms at different conduction angles ($f=50\text{Hz}$, DSC)

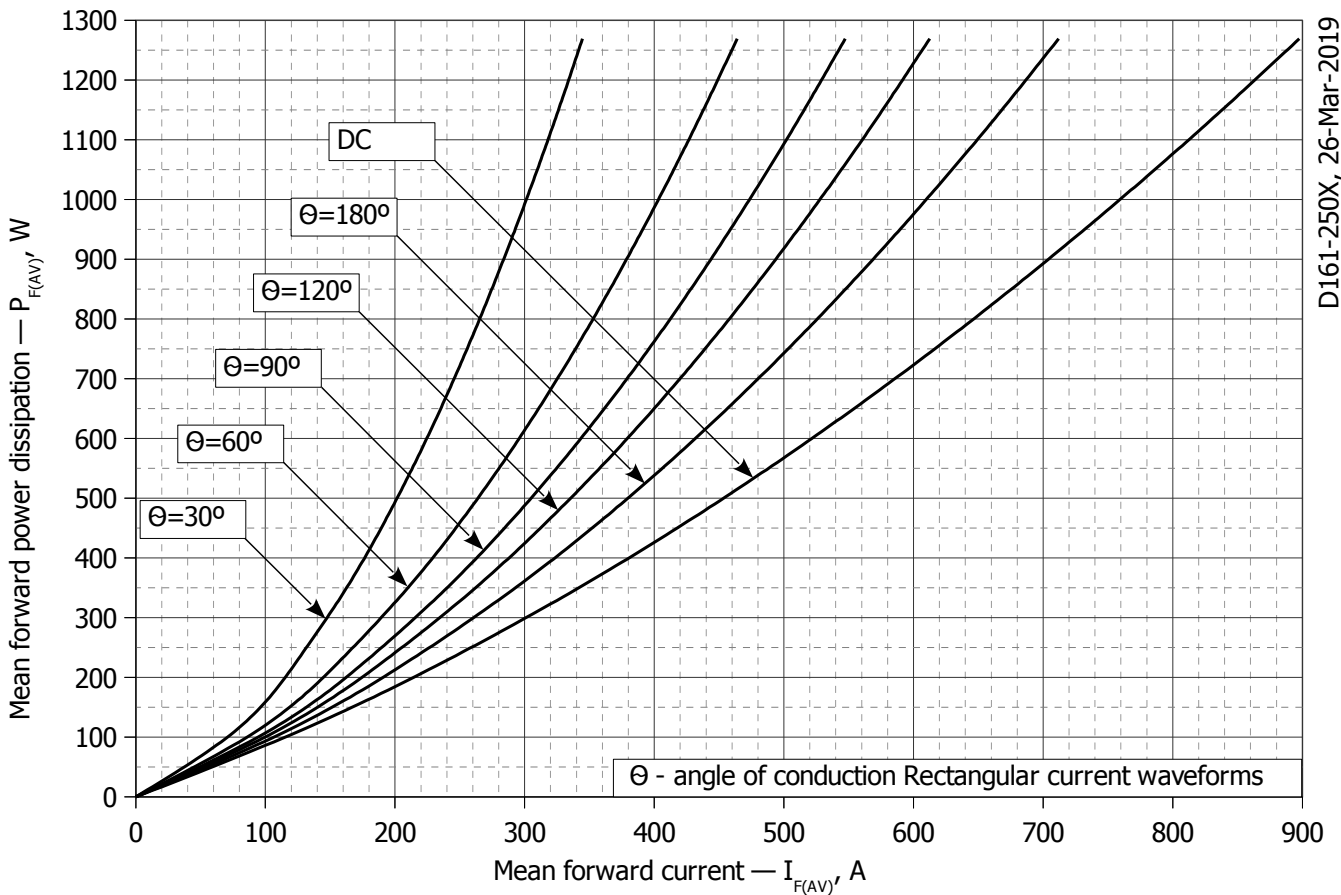

Fig. 8 - Mean forward power dissipation P_{FAV} vs. mean forward current I_{FAV} for rectangular current waveforms at different conduction angles and for DC ($f=50\text{Hz}$, DSC)

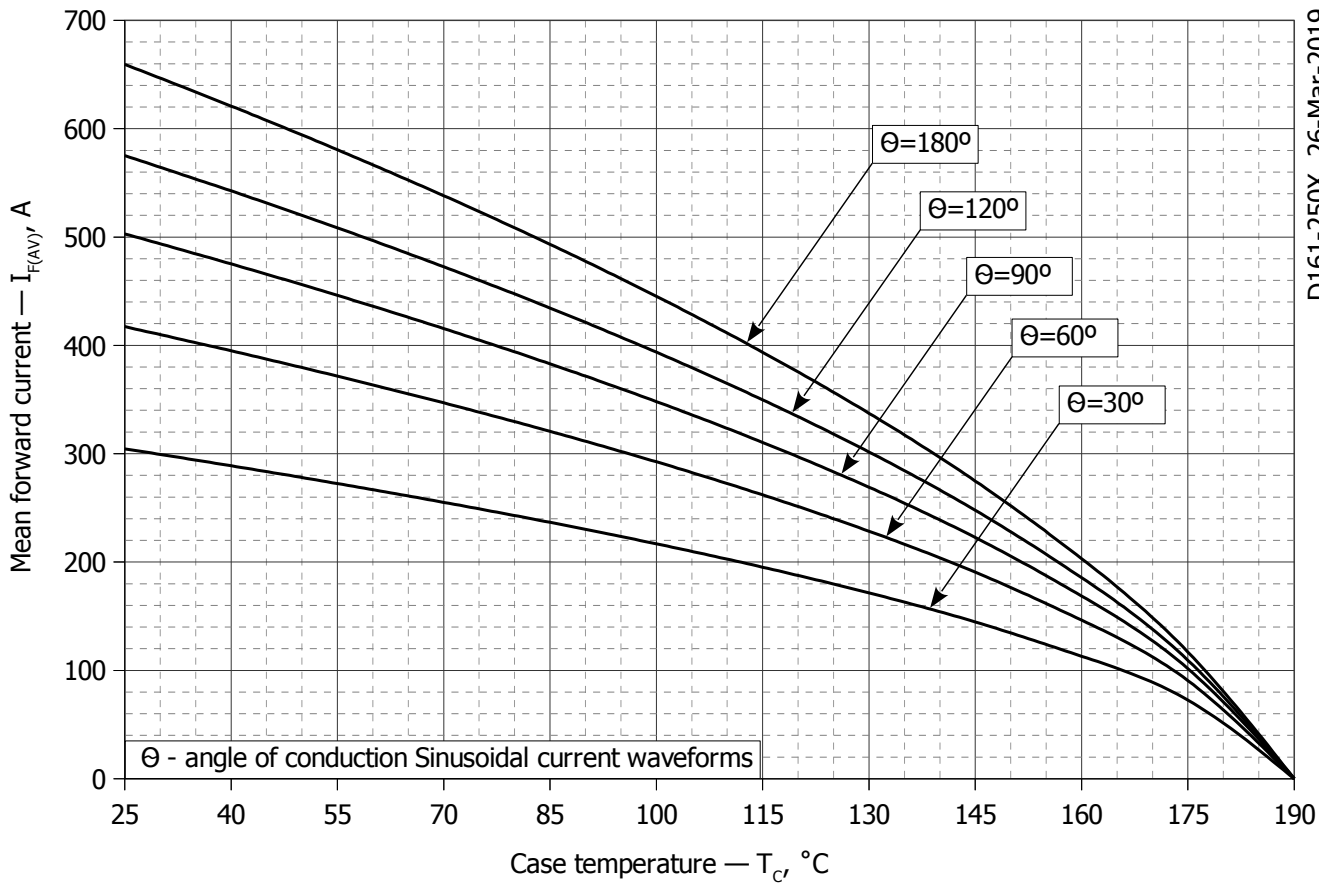

Fig. 9 – Mean forward current I_{FAV} vs. case temperature T_c for sinusoidal current waveforms at different conduction angles ($f=50\text{Hz}$, DSC)

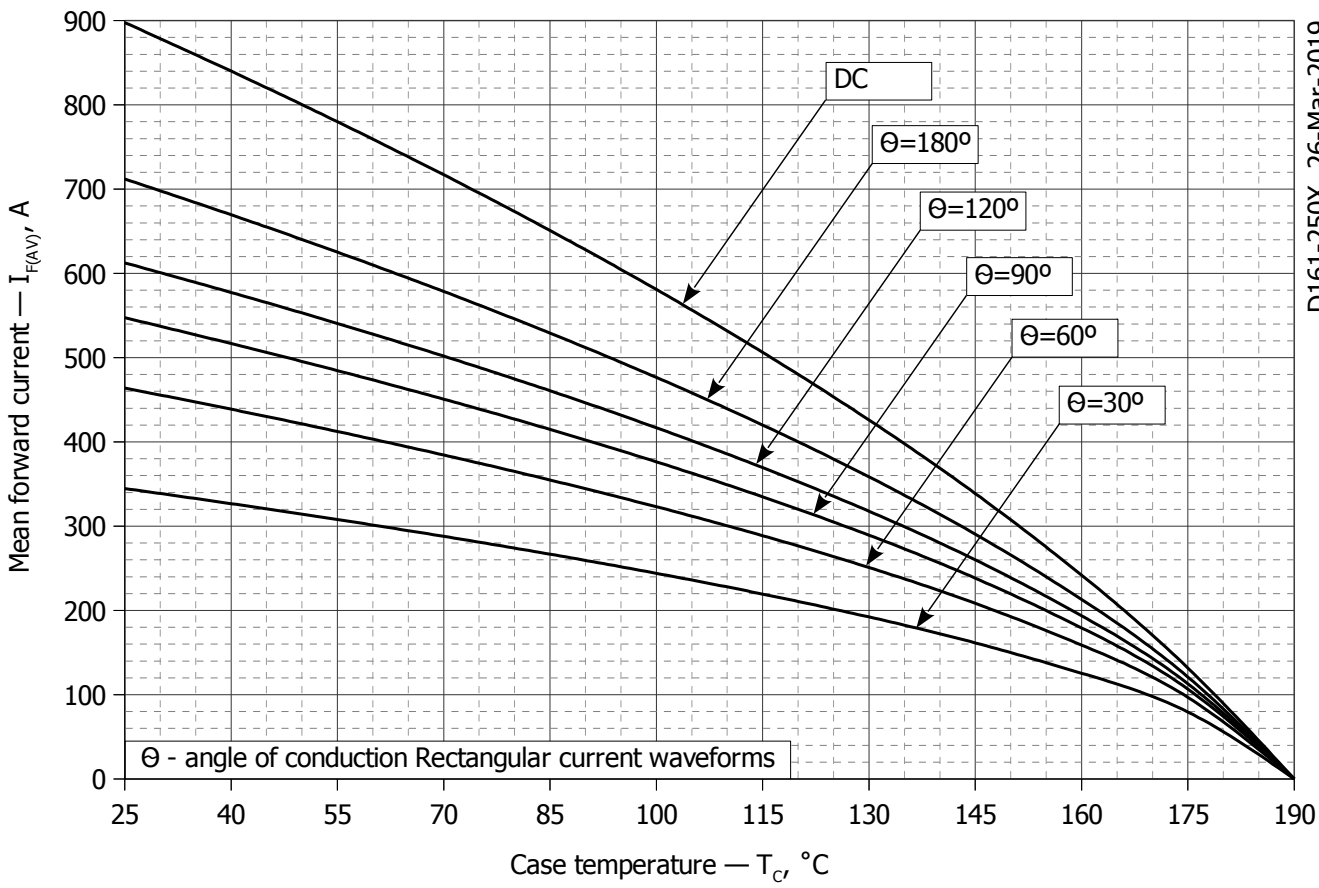

Fig. 10 - Mean forward current I_{FAV} vs. case temperature T_c for rectangular current waveforms at different conduction angles and for DC ($f=50\text{Hz}$, DSC)

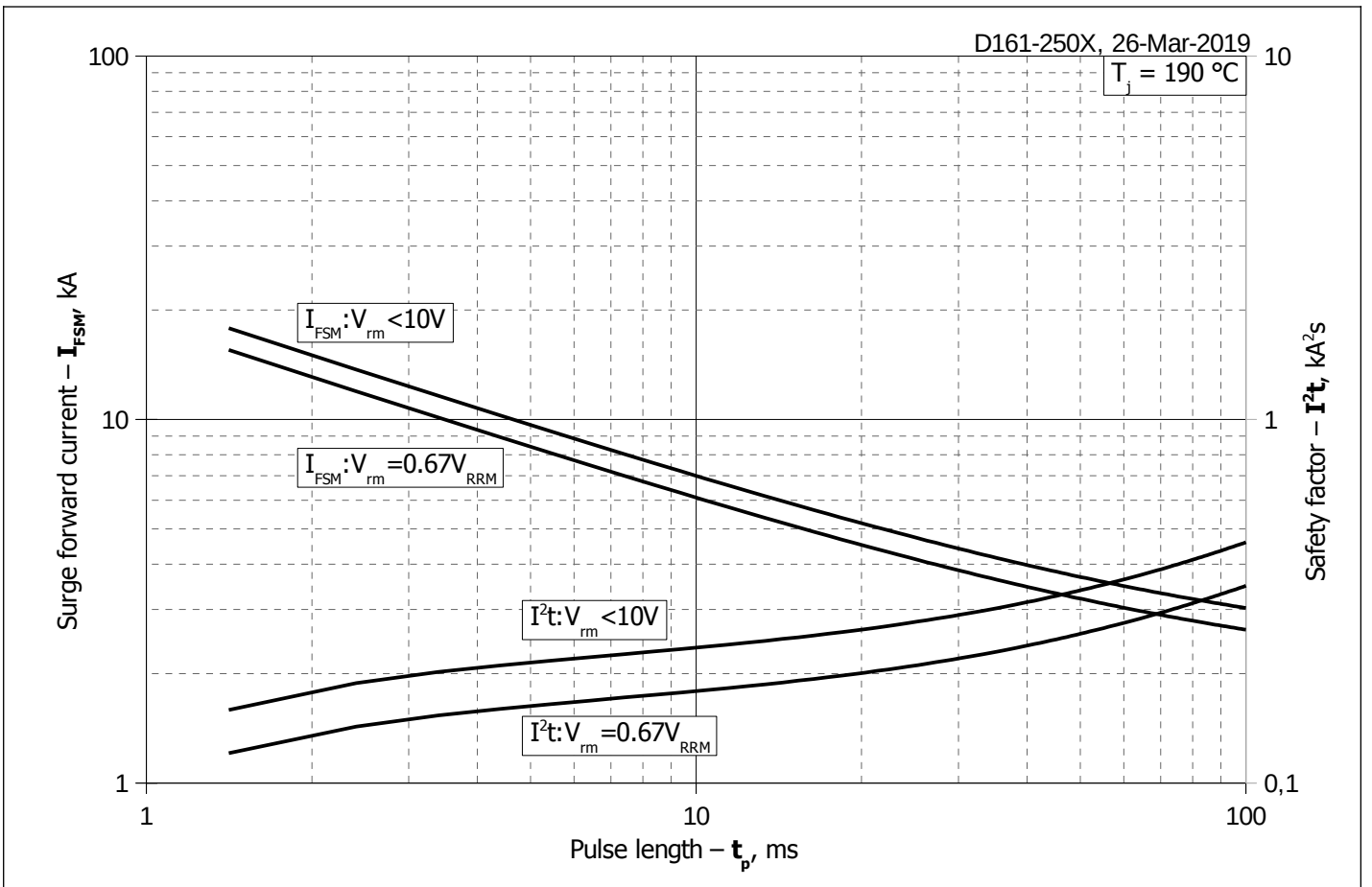

Fig. 11 – Maximum surge forward current I_{FSM} and safety factor I^2t vs. pulse length t_p

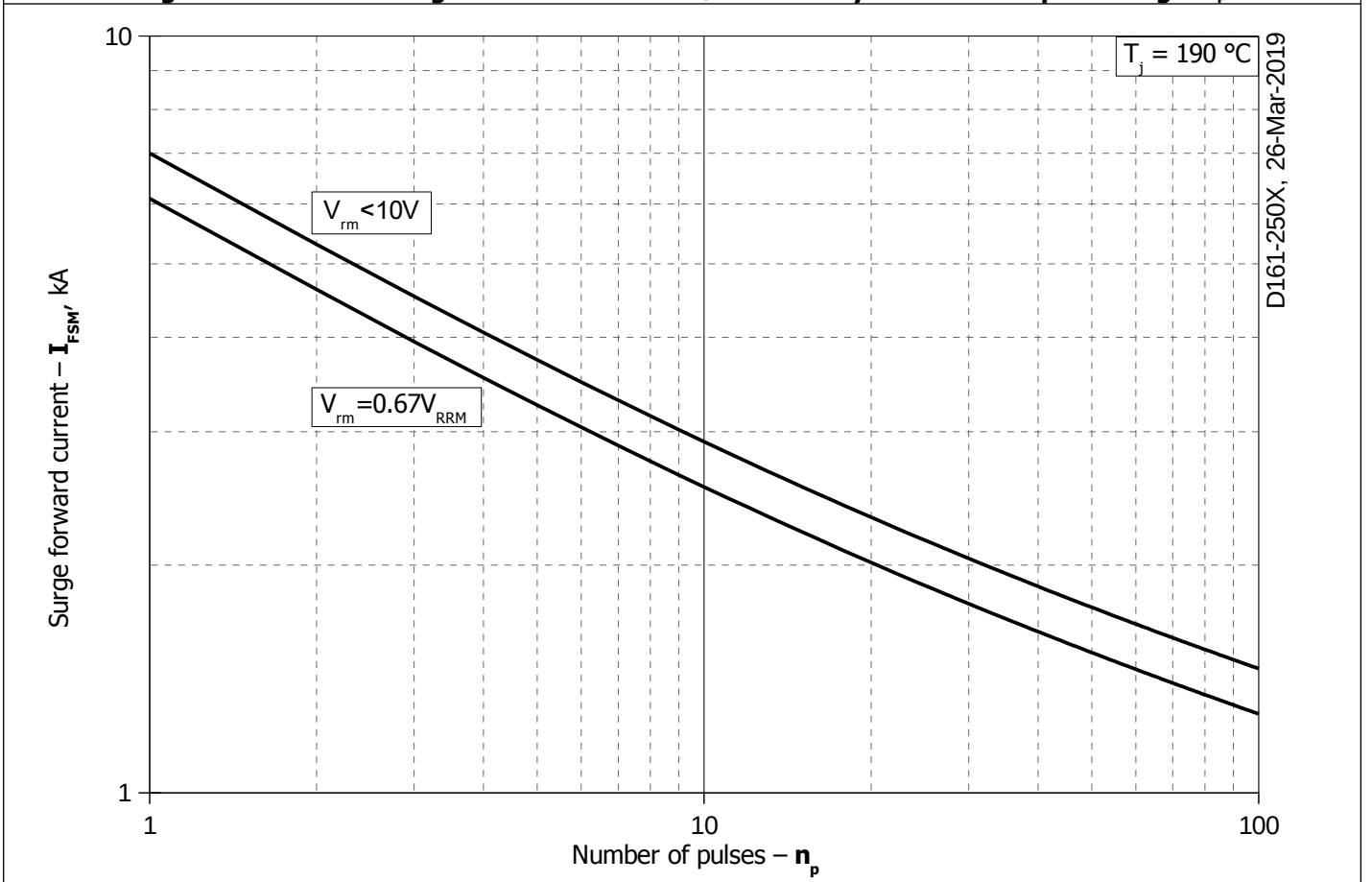

Fig. 12 - Maximum surge forward current I_{FSM} vs. number of pulses n_p