

Optimum power handling  
 Low on-state and switching losses  
 Designed for traction and industrial  
 applications

# Rectifier Stud Diode Type D161-400-16

Mean on-state current						$I_{FAV}$		400 A							
Repetitive peak reverse voltage						$V_{RRM}$		300 ÷ 1600V							
$V_{RRM}, V$	300	400	500	600	700	800	900	1000	1100	1200	1300	1400	1500	1600	
Voltage code	3	4	5	6	7	8	9	10	11	12	13	14	15	16	
$T_j, °C$	- 60 ÷ 190														

### MAXIMUM ALLOWABLE RATINGS

Symbols and parameters		Units	Values	Test conditions	
<b>ON-STATE</b>					
$I_{FAV}$	Average forward current	A	400 480	$T_c=120 °C$ ; $T_c=100 °C$ ; 180° half-sine wave; 50 Hz	
$I_{FRMS}$	RMS forward current	A	628	$T_c=120 °C$ ; 180° half-sine wave; 50 Hz	
$I_{FSM}$	Surge forward current	kA	7.5 9.0	$T_j=T_{jmax}$ $T_j=25 °C$	180° half-sine wave; $t_p=10 ms$ ; single pulse; $V_R=0 V$ ;
			8.0 9.5	$T_j=T_{jmax}$ $T_j=25 °C$	180° half-sine wave; $t_p=8.3 ms$ ; single pulse; $V_R=0 V$ ;
$I^2t$	Safety factor	$A^2s \cdot 10^3$	280 400	$T_j=T_{jmax}$ $T_j=25 °C$	180° half-sine wave; $t_p=10 ms$ ; single pulse; $V_R=0 V$ ;
			260 370	$T_j=T_{jmax}$ $T_j=25 °C$	180° half-sine wave; $t_p=8.3 ms$ ; single pulse; $V_R=0 V$ ;
<b>BLOCKING</b>					
$V_{RRM}$	Repetitive peak reverse voltages	V	300÷1600	$T_{jmin} < T_j < T_{jmax}$ ; 180° half-sine wave; 50 Hz;	
$V_{RSM}$	Non-repetitive peak reverse voltages	V	350÷1860	$T_{jmin} < T_j < T_{jmax}$ ; 180° half-sine wave; single pulse;	
$V_R$	Reverse continuous voltages	V	$0.6 \cdot V_{RRM}$	$T_j=T_{jmax}$ ;	
<b>THERMAL</b>					
$T_{stg}$	Storage temperature	°C	- 60 ÷ 50		
$T_j$	Operating junction temperature	°C	- 60 ÷ 190		
<b>MECHANICAL</b>					
M	Tightening torque	Nm	20 ÷ 30		
a	Acceleration	$m/s^2$	100		

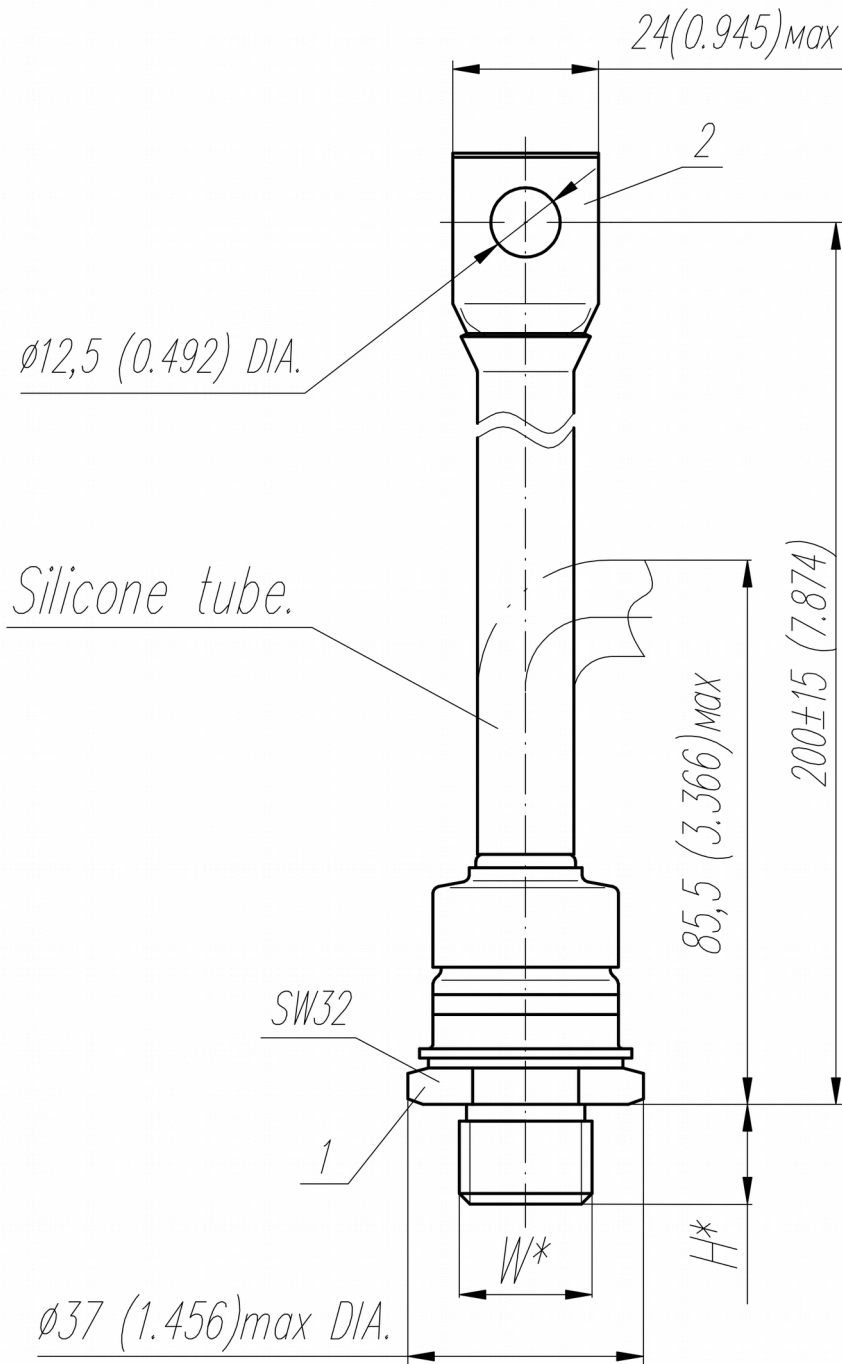
## CHARACTERISTICS

Symbols and parameters		Units	Values	Conditions
<b>ON-STATE</b>				
$V_{FM}$	Peak forward voltage, max	V	1.45	$T_j=25\text{ }^\circ\text{C}; I_{FM}=1256\text{ A}$
$V_{F(TO)}$	Forward threshold voltage, max	V	0.836	$T_j=T_{j\text{ max}};$
$r_T$	Forward slope resistance, max	m $\Omega$	0.516	$0.5\pi I_{FAV} < I_T < 1.5\pi I_{FAV}$
<b>BLOCKING</b>				
$I_{RRM}$	Repetitive peak reverse current, max	mA	40	$T_j=T_{j\text{ max}};$ $V_R=V_{RRM}$
<b>SWITCHING</b>				
$Q_{rr}$	Total recovered charge, max	$\mu\text{C}$	900	$T_j=T_{j\text{ max}}; I_{TM}=400\text{ A};$
$t_{rr}$	Reverse recovery time, max	$\mu\text{s}$	18	$di_R/dt=-10\text{ A}/\mu\text{s};$
$I_{rrM}$	Peak reverse recovery current, max	A	100	$V_R=100\text{ V};$
<b>THERMAL</b>				
$R_{thjc}$	Thermal resistance, junction to case, max	$^\circ\text{C}/\text{W}$	0.130	Direct current
<b>MECHANICAL</b>				
w	Weight, max	g	240	
$D_s$	Surface creepage distance	mm (inch)	12.4 (4.882)	
$D_a$	Air strike distance	mm (inch)	12.4 (4.882)	

### PART NUMBERING GUIDE

D	161	400		16	N
1	2	3	4	5	6

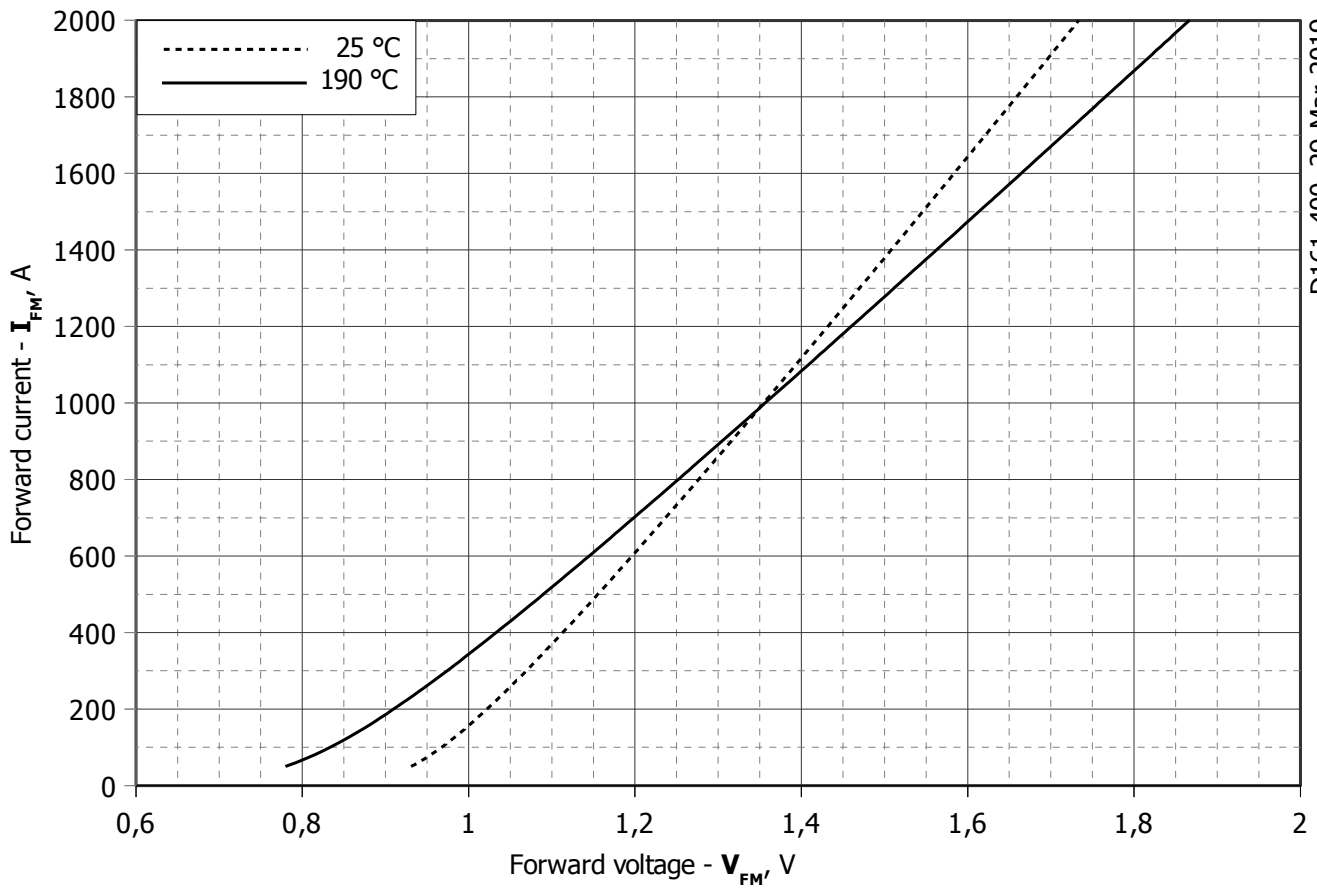
1. D — Rectifier Diode
2. Design version
3. Average forward current, A
4. Polarity: X – Cathode to Stud; Anode to Stud – no symbol
5. Voltage code
6. Ambient conditions: N – normal; T – tropical



Type of screw	W	H
Metric Screw Type A (upon request)	M16x1,5 – 8g	13
Metric Screw Type B	M20x1,5 – 8g	15

Polarity		Example of code designation	Reference designation	Colors	
				Anode	Cathode
Normal	Anode to stud	D161-400-16	$\nabla$	-	Red tube

All dimensions in millimeters (inches)



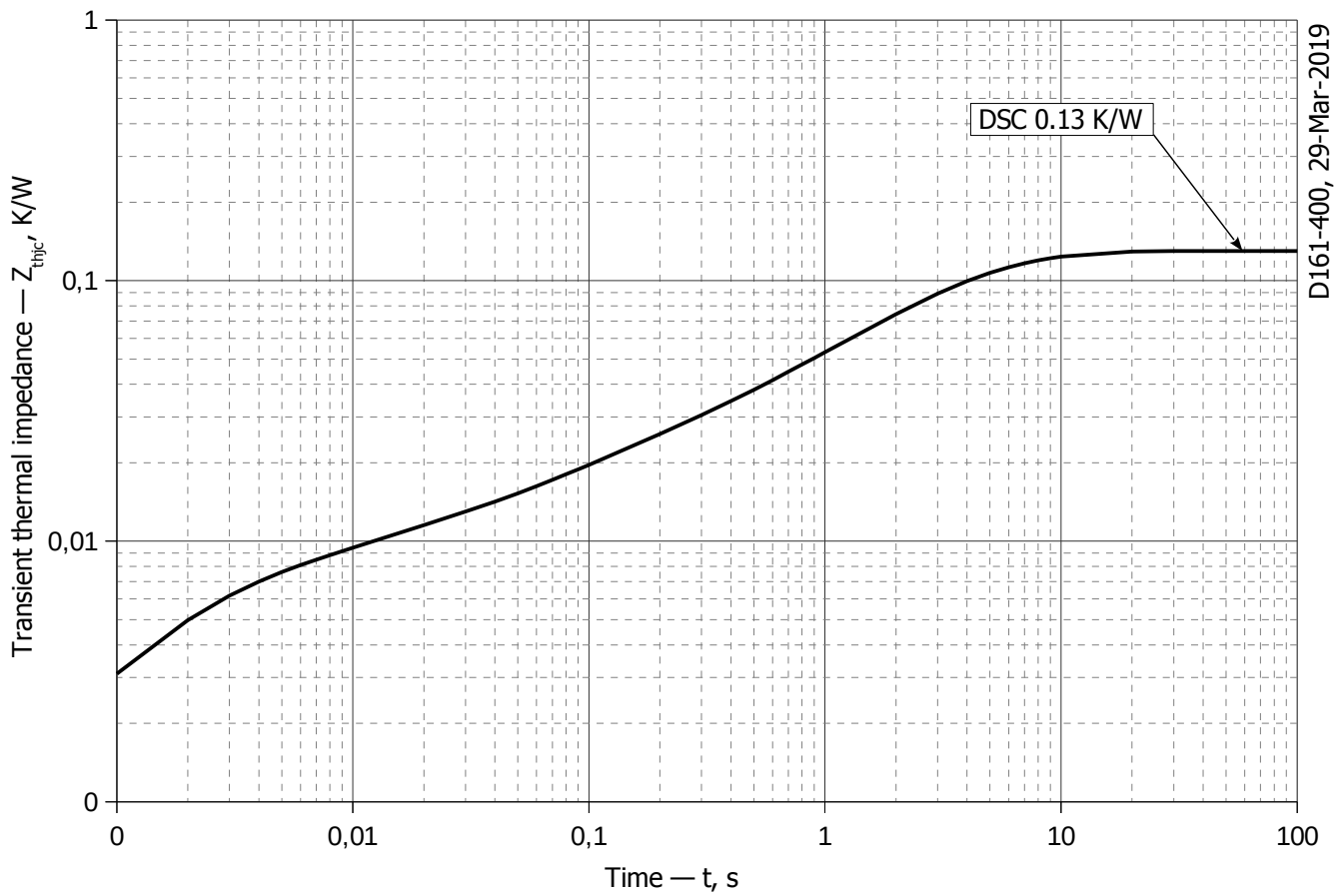
**Fig 1 – Forward characteristics of Limit device**

Analytical function for Forward characteristic:

$$V_F = A + B \cdot i_F + C \cdot \ln(i_F + 1) + D \cdot \sqrt{i_F}$$

	Coefficients for max curves	
	$T_j = 25^\circ\text{C}$	$T_j = T_{j \max}$
<b>A</b>	0,80979000	0,56957000
<b>B</b>	0,00035661	0,00050214
<b>C</b>	0,02562700	0,05078300
<b>D</b>	0,00035666	-0,00208410

**Forward characteristic model (see Fig. 1).**



D161-400, 29-Mar-2019

**Fig 2 – Transient thermal impedance  $Z_{thjc}$  vs. time  $t$**

Analytical function for Transient thermal impedance junction to case  $Z_{thjc}$  for DC:

$$Z_{thjc} = \sum_{i=1}^n R_i \left( 1 - e^{-\frac{t}{\tau_i}} \right)$$

Where  $i = 1$  to  $n$ ,  $n$  is the number of terms in the series.

$t$  = Duration of heating pulse in seconds.

$Z_{thjc}$  = Thermal resistance at time  $t$ .

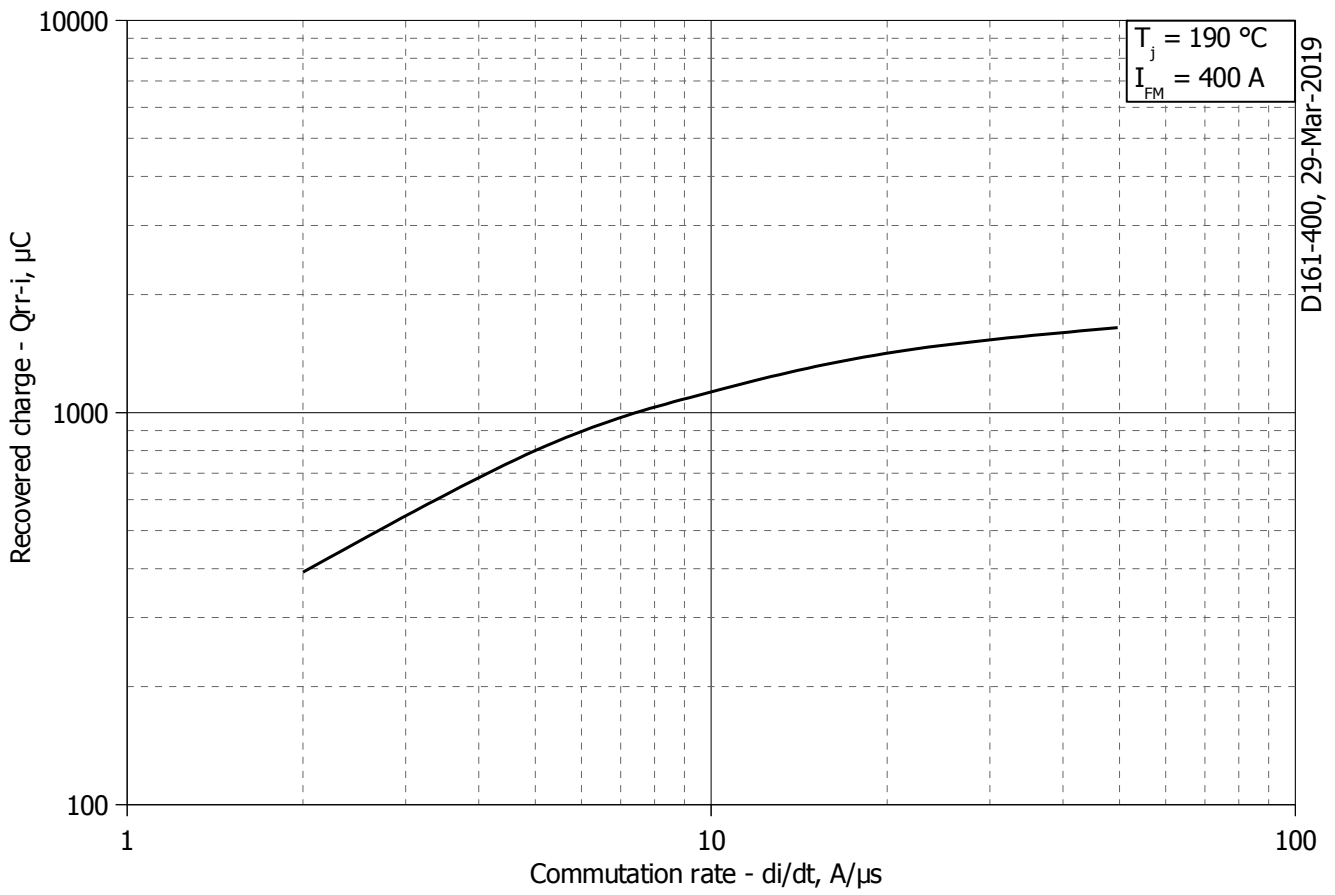
$R_i$  = Amplitude of  $p_{th}$  term.

$\tau_i$  = Time constant of  $r_{th}$  term.

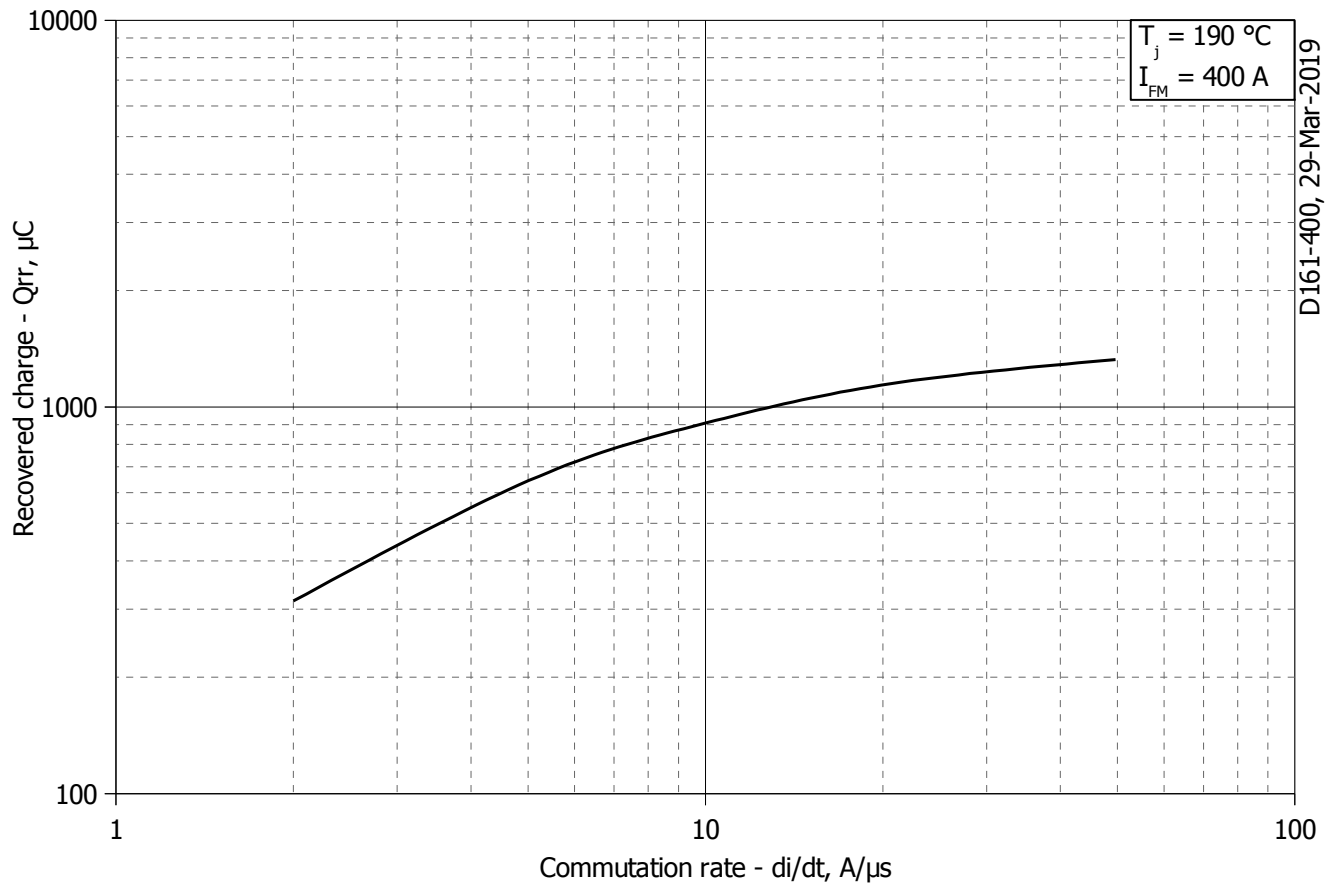
DC

<b>i</b>	<b>1</b>	<b>2</b>	<b>3</b>	<b>4</b>	<b>5</b>	<b>6</b>
<b><math>R_i</math>, K/W</b>	0.05504	0.0516	0.007369	0.006977	0.003512	0.005502
<b><math>\tau_i</math>, s</b>	4.409	2.183	0.3382	0.07307	0.008189	0.001615

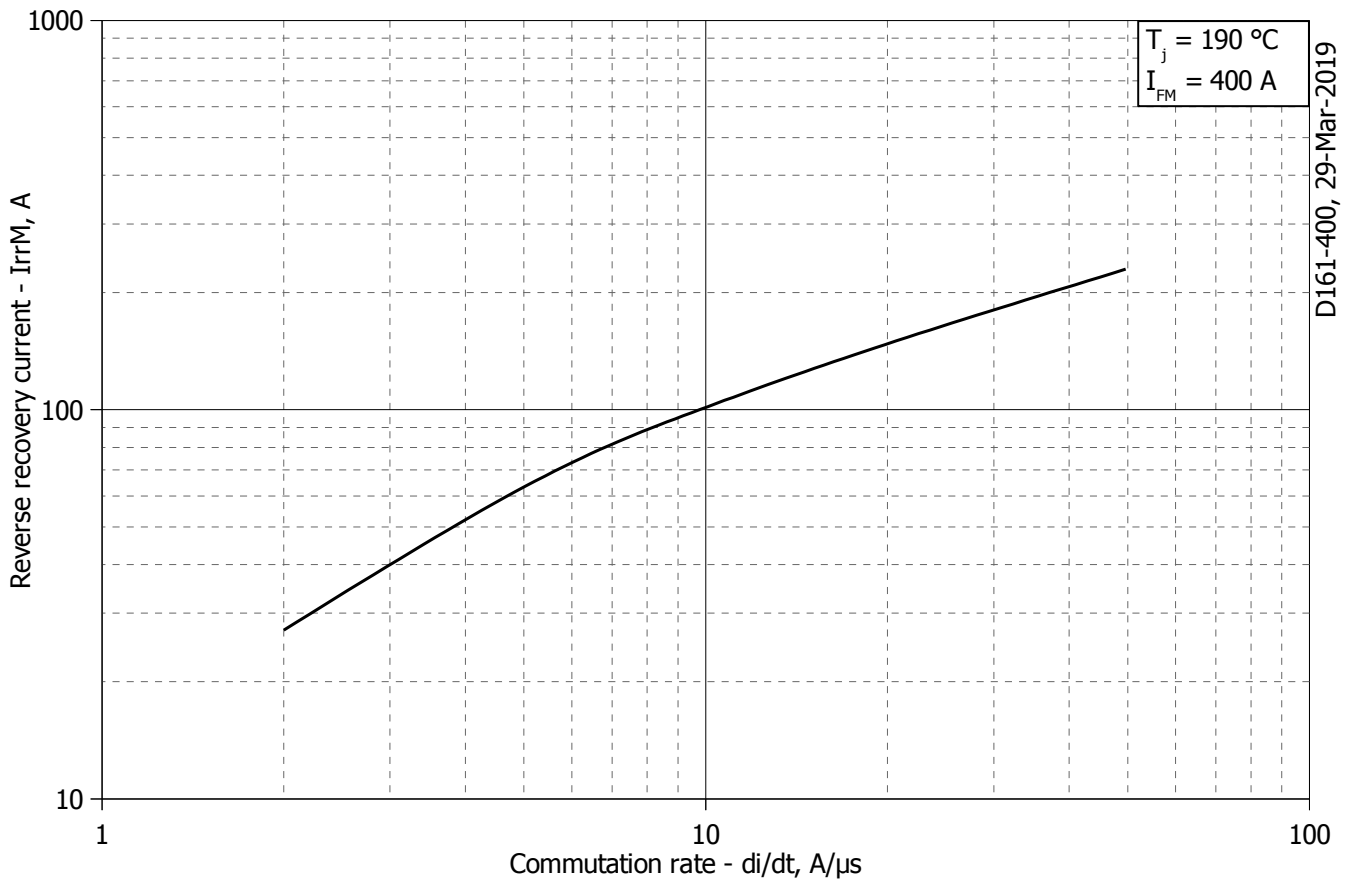
**Transient thermal impedance junction to case  $Z_{thjc}$  model (see Fig. 2)**



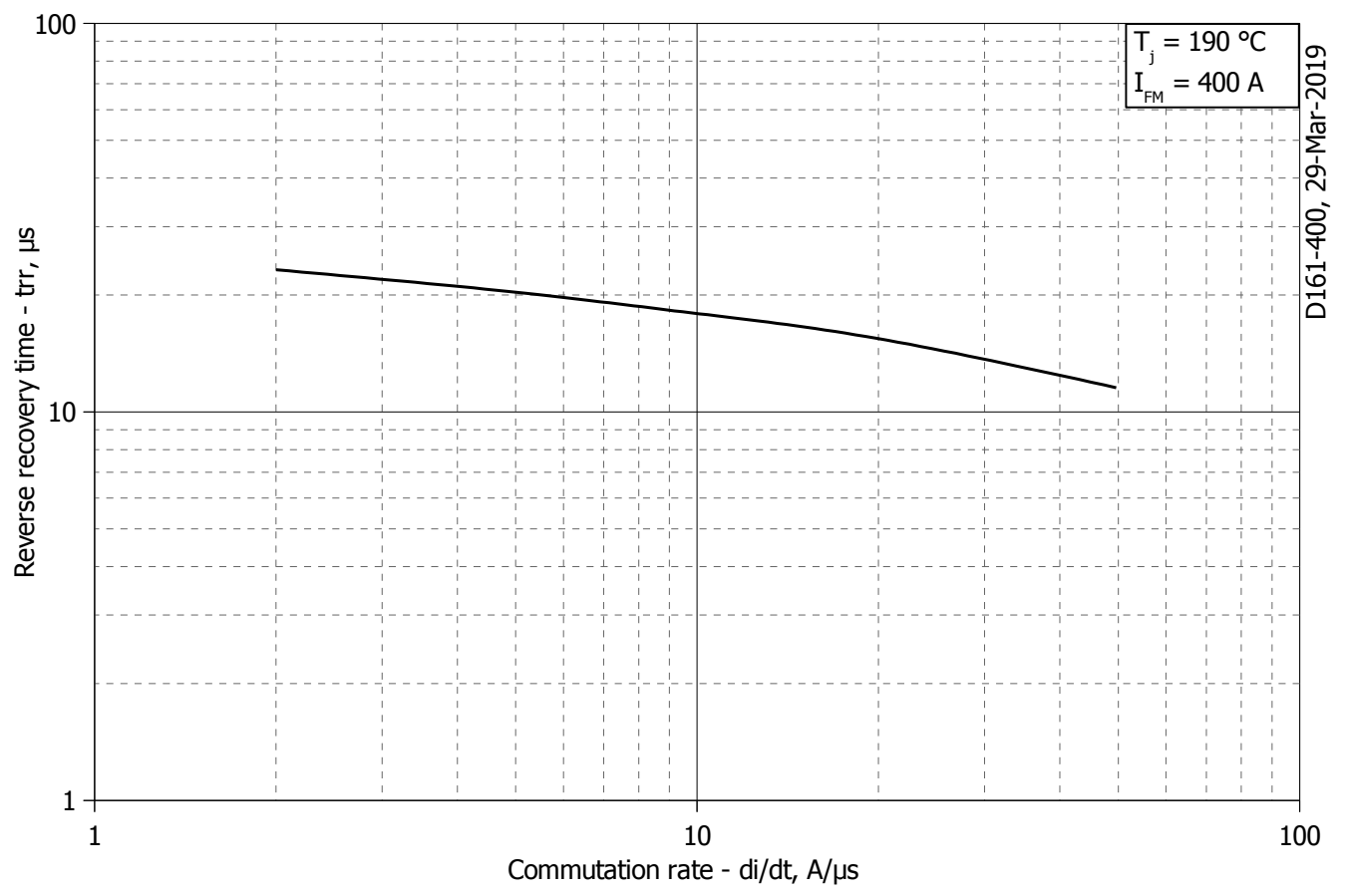
**Fig 3 – Maximum recovered charge  $Q_{rr-i}$  (integral) vs. commutation rate  $di_R/dt$**



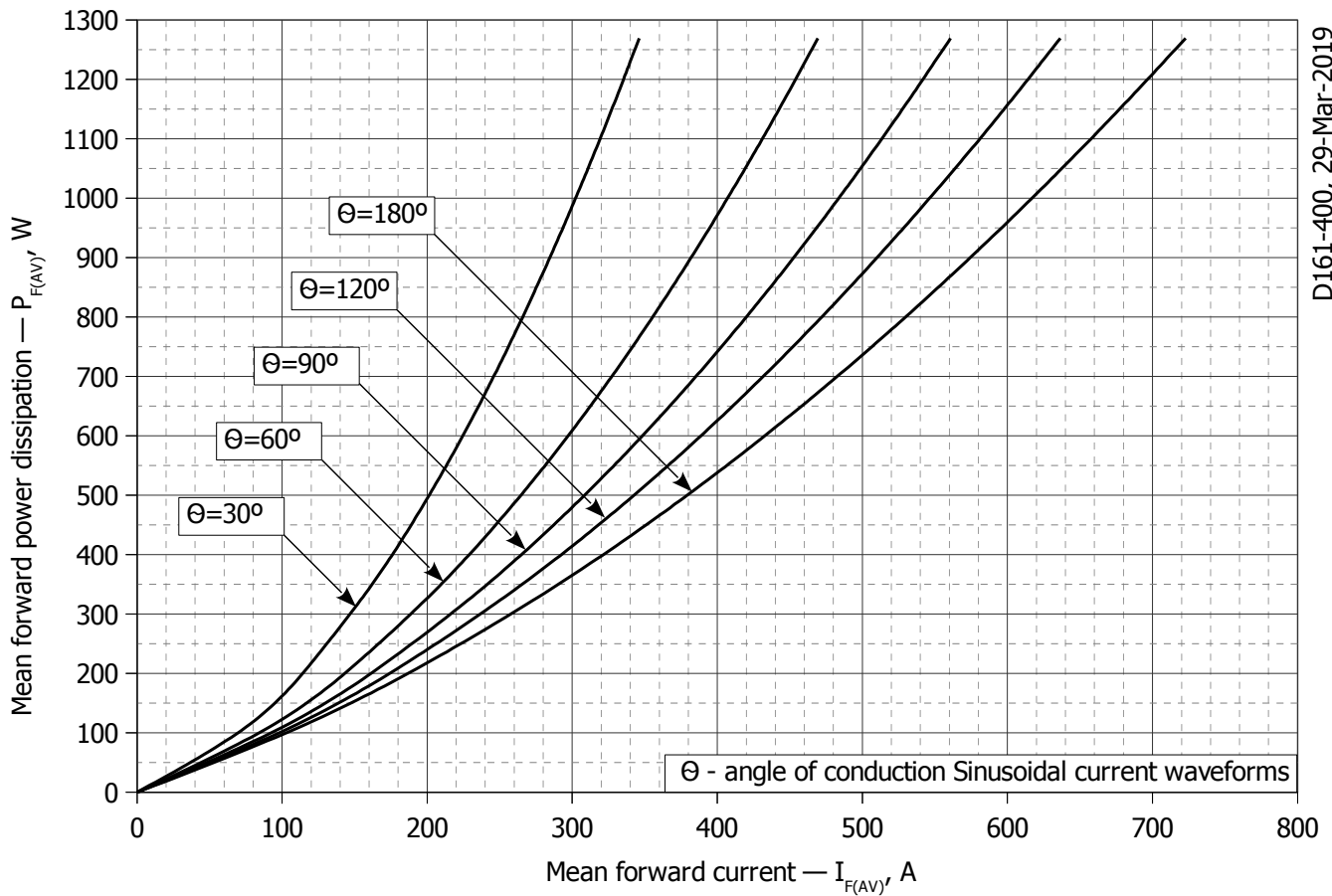
**Fig 4 – Maximum recovered charge  $Q_{rr}$  vs. commutation rate  $di_R/dt$  (25% chord)**



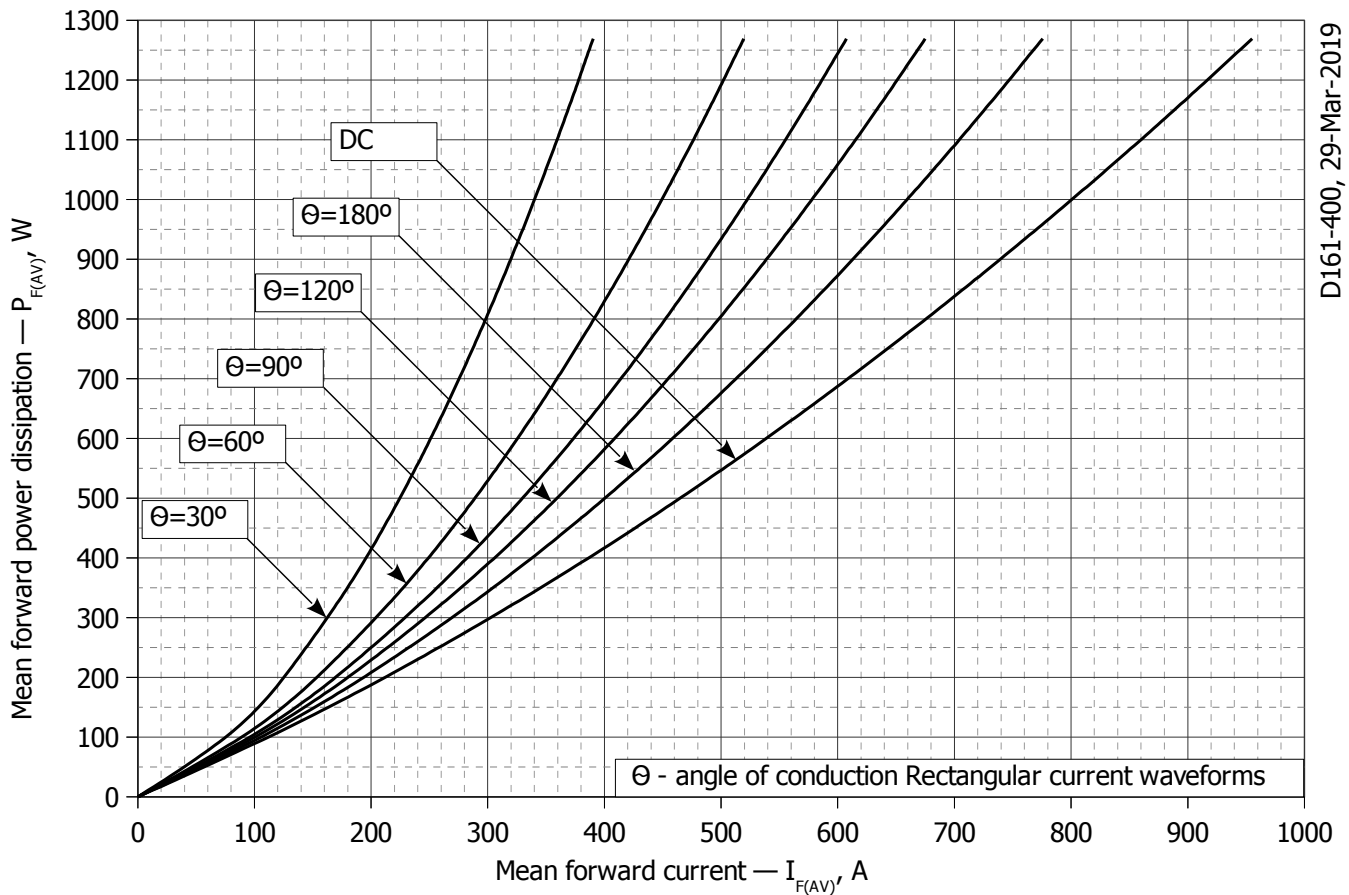
**Fig 5 – Maximum reverse recovery current  $I_{rrM}$  vs. commutation rate  $di_R/dt$**



**Fig 6 – Maximum recovery time  $t_{rr}$  vs. commutation rate  $di_R/dt$  (25% chord)**

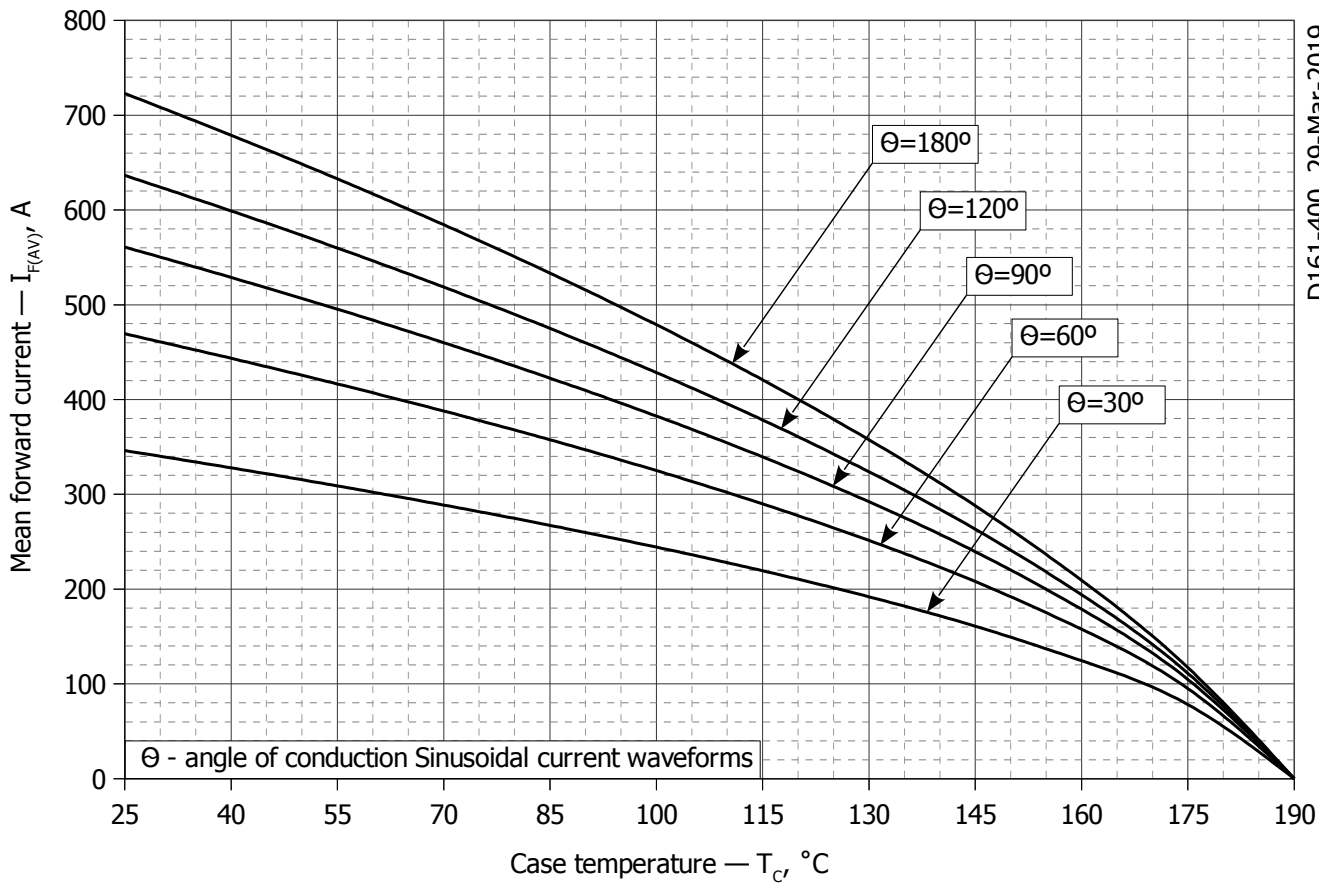


**Fig. 7 - Mean forward power dissipation  $P_{FAV}$  vs. mean forward current  $I_{FAV}$  for sinusoidal current waveforms at different conduction angles ( $f=50\text{Hz}$ , DSC)**

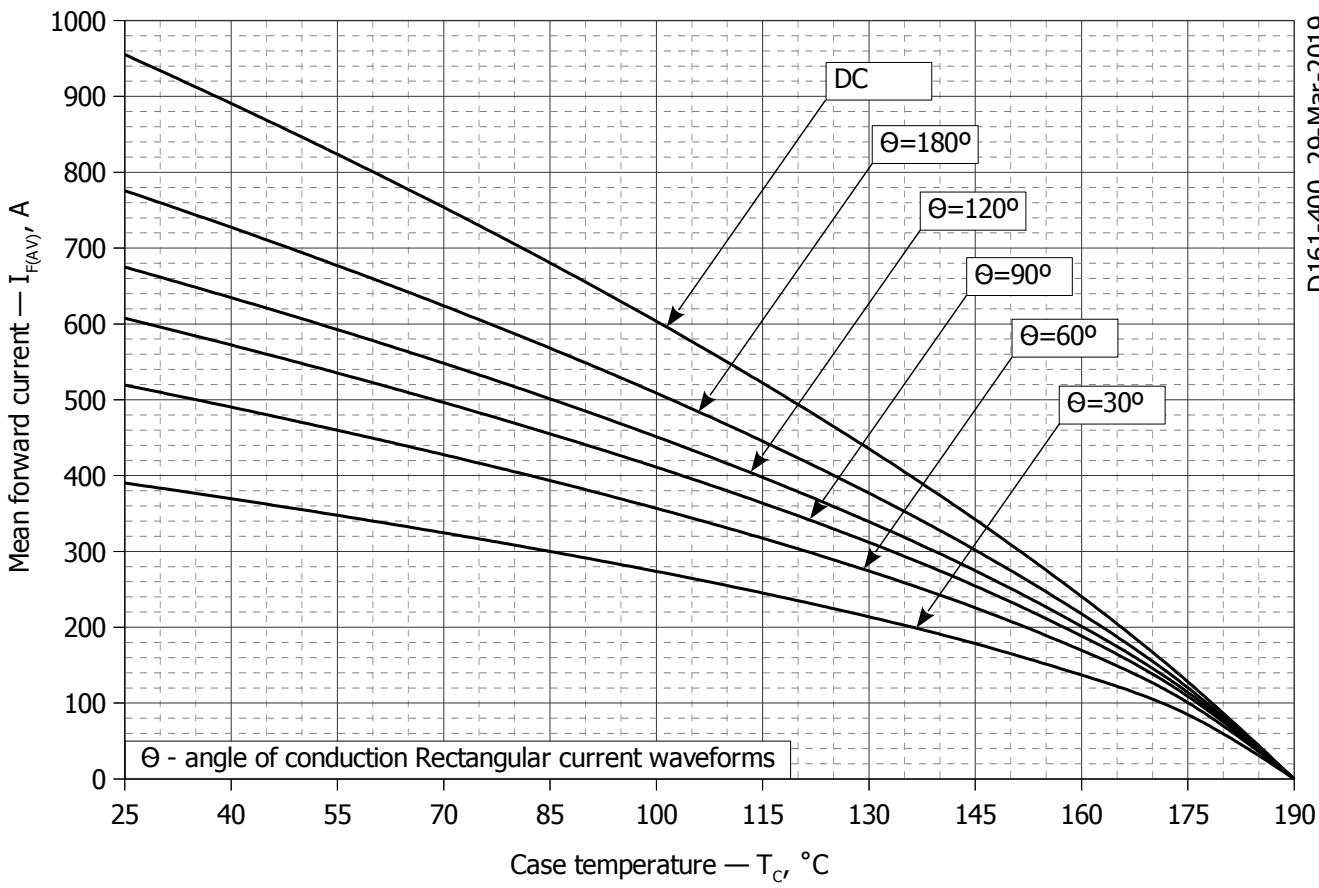


**Fig. 8 - Mean forward power dissipation  $P_{FAV}$  vs. mean forward current  $I_{FAV}$  for rectangular current waveforms at different conduction angles and for DC ( $f=50\text{Hz}$ , DSC)**

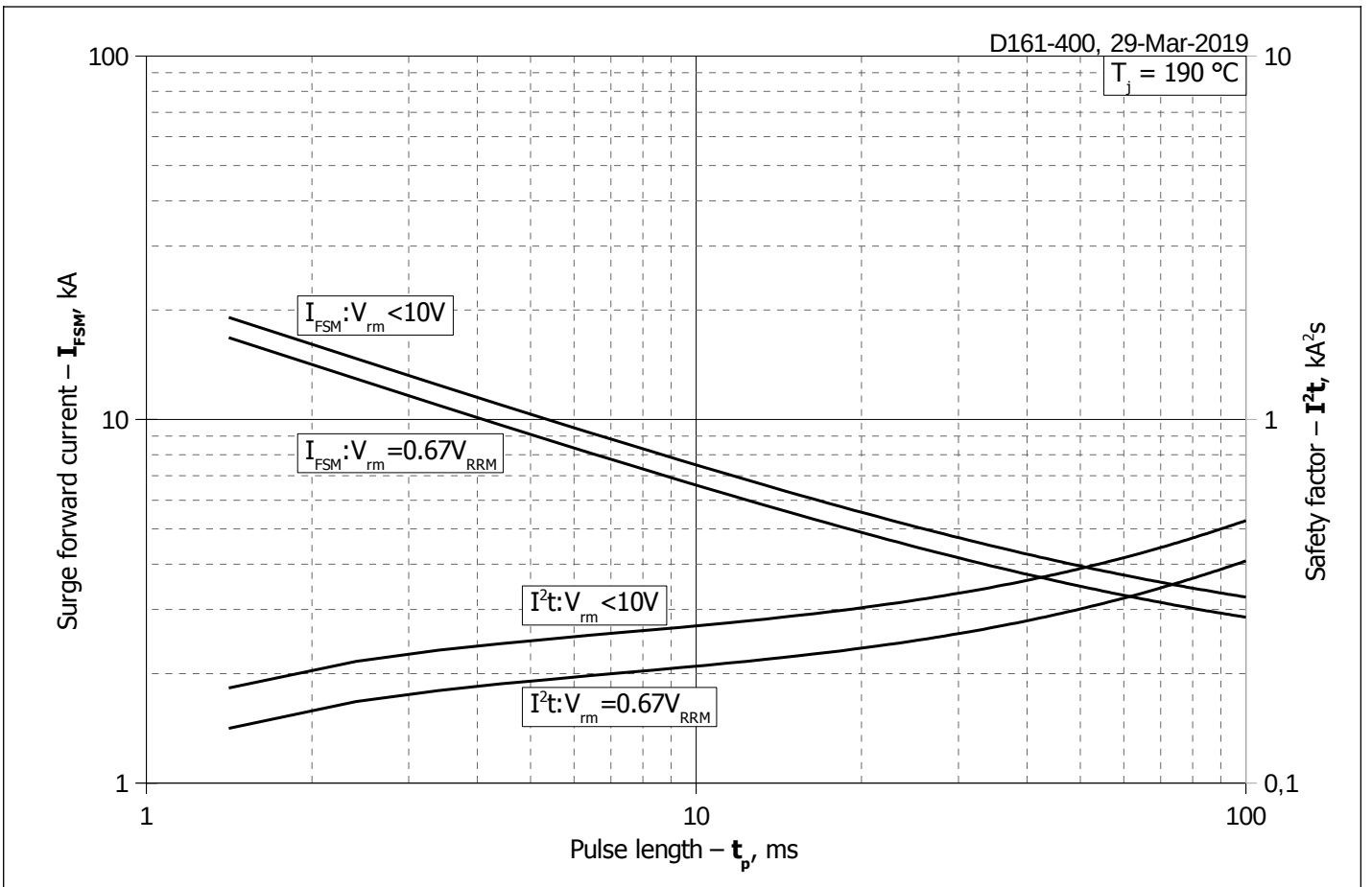




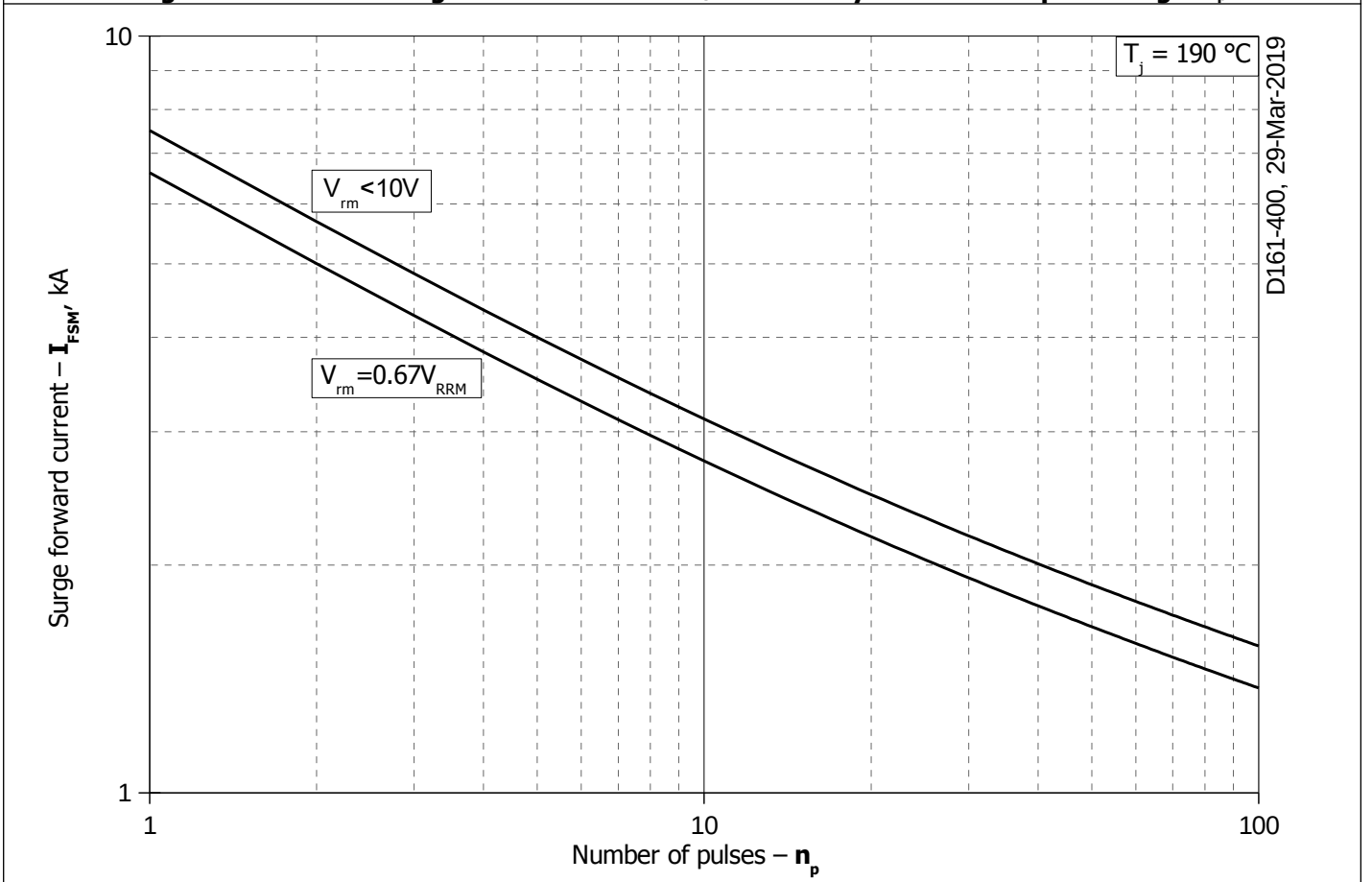
**Fig. 9 – Mean forward current  $I_{FAV}$  vs. case temperature  $T_c$  for sinusoidal current waveforms at different conduction angles ( $f=50\text{Hz}$ , DSC)**



**Fig. 10 - Mean forward current  $I_{FAV}$  vs. case temperature  $T_c$  for rectangular current waveforms at different conduction angles and for DC ( $f=50\text{Hz}$ , DSC)**



**Fig. 11 – Maximum surge forward current  $I_{FSM}$  and safety factor  $I^2t$  vs. pulse length  $t_p$**



**Fig. 12 - Maximum surge forward current  $I_{FSM}$  vs. number of pulses  $n_p$**