

High power cycling capability
 Low on-state and switching losses
 Optimized for line frequency rectifiers
 Designed for traction and industrial applications

Power Rectifier Avalanche Diodes Type DA273-3200-36

Average forward current		I_{FAV}	3200 A	
Repetitive peak reverse voltage		V_{RRM}	3000 ÷ 3600 V	
V_{RRM}, V	3000	3200	3400	3600
Voltage code	30	32	34	36
$T_j, °C$	- 60 ÷ 175			

MAXIMUM ALLOWABLE RATINGS

Symbols and parameters		Units	Values	Test conditions
ON-STATE				
I_{FAV}	Average forward current	A	3200 3305	$T_c=106 °C$; Double side cooled; $T_c=100 °C$; Double side cooled; 180° half-sine wave; 50 Hz
I_{FRMS}	RMS forward current	A	5024	$T_c=106 °C$; Double side cooled; 180° half-sine wave; 50 Hz
I_{FSM}	Surge forward current	kA	42.0 50.0	$T_j=T_{j,max}$ $T_j=25 °C$ 180° half-sine wave; $t_p=10$ ms; single pulse; $V_R=0$ V;
			44.0 53.0	$T_j=T_{j,max}$ $T_j=25 °C$ 180° half-sine wave; $t_p=8.3$ ms; single pulse; $V_R=0$ V;
I^2t	Safety factor	$A^2s \cdot 10^3$	8800 12500	$T_j=T_{j,max}$ $T_j=25 °C$ 180° half-sine wave; $t_p=10$ ms; single pulse; $V_R=0$ V;
			8000 11600	$T_j=T_{j,max}$ $T_j=25 °C$ 180° half-sine wave; $t_p=8.3$ ms; single pulse; $V_R=0$ V;
BLOCKING				
V_{RRM}	Repetitive peak reverse voltages	V	3000÷3600	$T_{j,min} < T_j < T_{j,max}$; 180° half-sine wave; 50 Hz;
$V_{(BR)}$	Breakdown voltage	V	3450÷4050	$T_j=25 °C$; $I_{br}=100$ mA; $t_p = 10$ ms; 5 Hz
V_R	Reverse continuous voltages	V	$0.6 \cdot V_{RRM}$	$T_j=T_{j,max}$;
P_{RSM}	Surge reverse power dissipation	kW	16	$T_j= T_{j,max}$; $t_p = 100$ μ s; 180° half-sine current waveforms; single pulse
THERMAL				
T_{stg}	Storage temperature	°C	- 60 ÷ 50	
T_j	Operating junction temperature	°C	- 60 ÷ 175	
MECHANICAL				
F	Mounting force	kN	40.0 ÷ 50.0	
a	Acceleration	m/s^2	50	Device clamped

CHARACTERISTICS

Symbols and parameters		Units	Values	Conditions
ON-STATE				
V_{FM}	Peak forward voltage, max	V	2.20	$T_j=25\text{ }^\circ\text{C}; I_{FM}=10048\text{ A}$
$V_{F(TO)}$	Forward threshold voltage, max	V	1.05	$T_j=T_{j\text{ max}};$
r_T	Forward slope resistance, max	m Ω	0.200	$0.5\pi I_{FAV} < I_T < 1.5\pi I_{FAV}$
BLOCKING				
I_{RRM}	Repetitive peak reverse current, max	mA	150	$T_j=T_{j\text{ max}};$ $V_R=V_{RRM}$
SWITCHING				
Q_{rr}	Total recovered charge, max	μC	5550	$T_j=T_{j\text{ max}}; I_{TM}=1500\text{ A};$
t_{rr}	Reverse recovery time, max	μs	75.0	$di_R/dt=-5\text{ A}/\mu\text{s};$
I_{rrM}	Peak reverse recovery current, max	A	148	$V_R=100\text{ V};$
THERMAL				
R_{thjc}	Thermal resistance, junction to case, max	$^\circ\text{C}/\text{W}$	0.0082	Double side cooled
R_{thjc-A}			0.0187	Anode side cooled
R_{thjc-K}			0.0153	Cathode side cooled
R_{thck}	Thermal resistance, case to heatsink, max	$^\circ\text{C}/\text{W}$	0.0020	Direct current
MECHANICAL				
w	Weight, max	g	1500	
D_s	Surface creepage distance	mm (inch)	41.40 (1.630)	
D_a	Air strike distance	mm (inch)	23.10 (0.909)	

PART NUMBERING GUIDE

DA	273	3200	36	N
1	2	3	4	5

1. DA — Avalanche Diode
2. Design version
3. Average forward current, A
4. Voltage code
5. Ambient conditions: N – normal; T – tropical

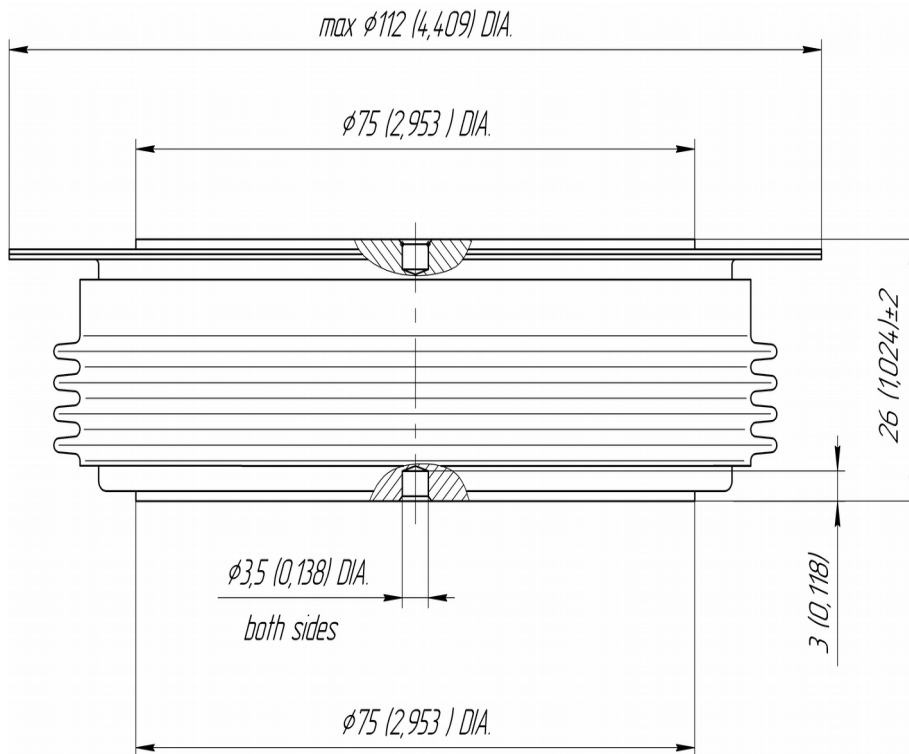

All dimensions in millimeters (inches)

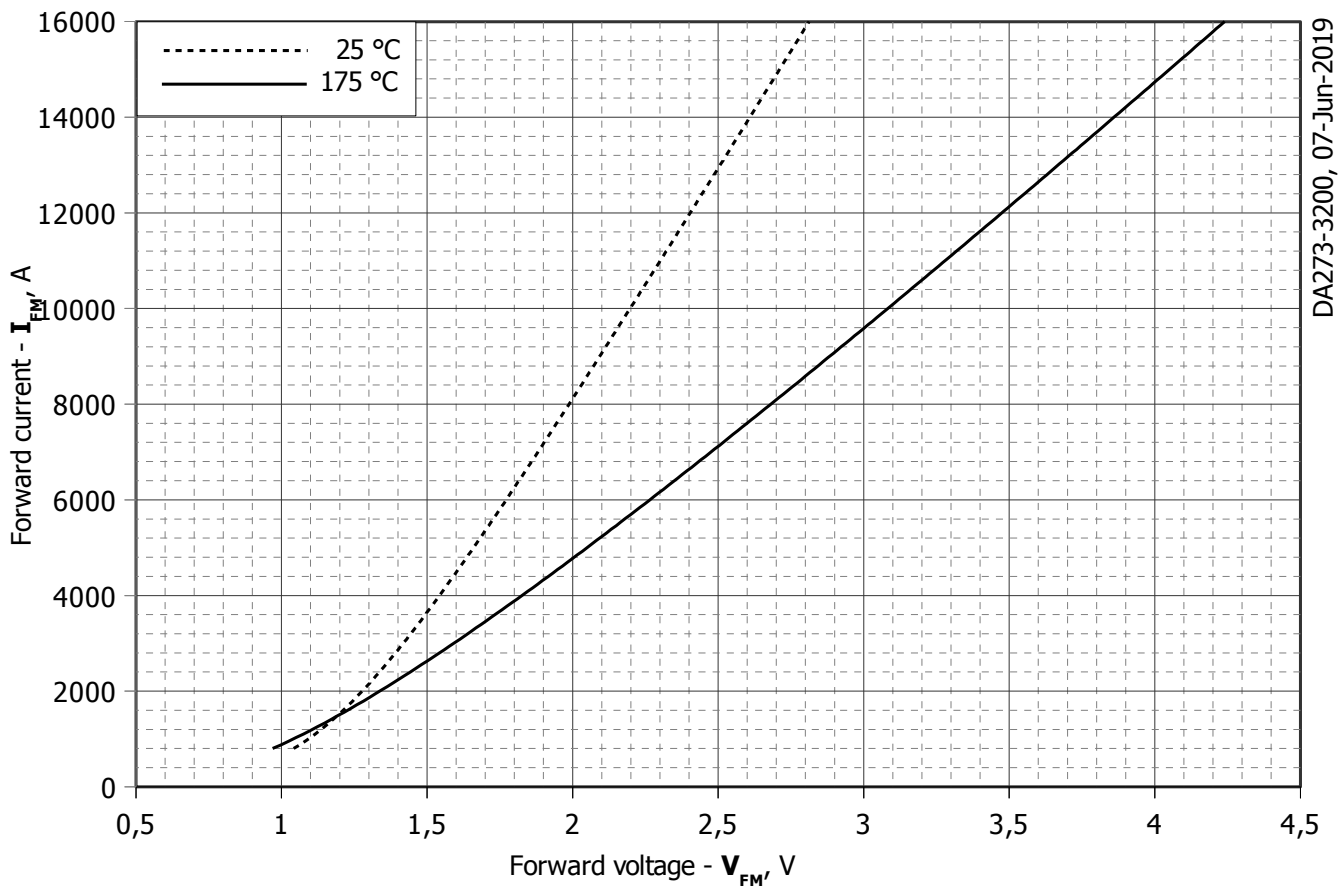
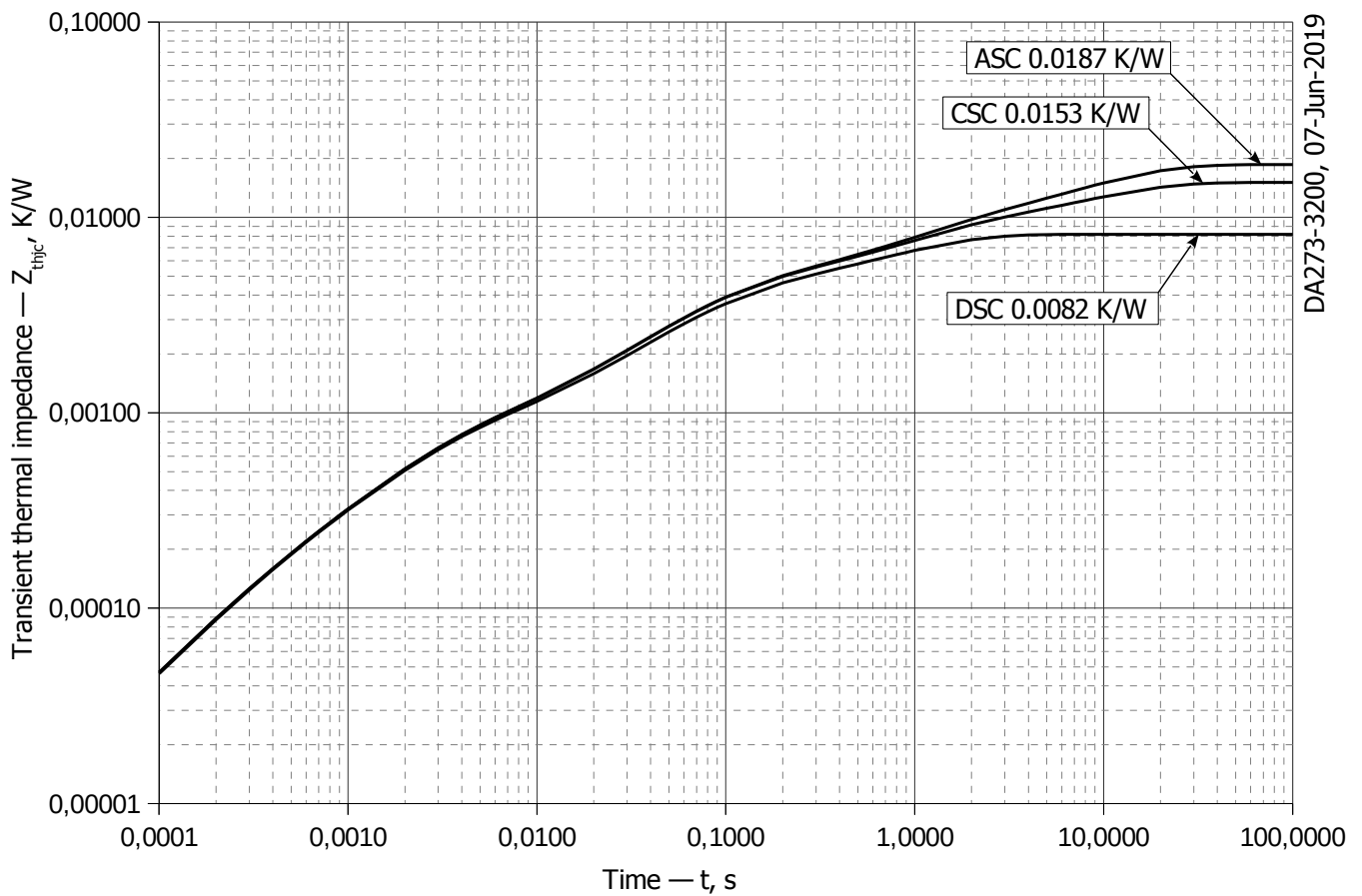

Fig 1 – Forward characteristics of Limit device

$$V_F = A + B \cdot i_F + C \cdot \ln(i_F + 1) + D \cdot \sqrt{i_F}$$

	Coefficients for max curves	
	$T_j = 25^\circ\text{C}$	$T_j = T_{j\text{max}}$
A	-0.27916000	0.10736000
B	0.00010897	0.00016001
C	0.20615000	0.08469000
D	-0.00511710	0.00595080

Forward characteristic model (see Fig. 1).



DA273-3200, 07-Jun-2019

Fig 2 – Transient thermal impedance Z_{thjc} vs. time t

Analytical function for Transient thermal impedance junction to case Z_{thjc} for DC:

$$Z_{thjc} = \sum_{i=1}^n R_i \left(1 - e^{-\frac{t}{\tau_i}} \right)$$

Where $i = 1$ to n , n is the number of terms in the series.

t = Duration of heating pulse in seconds.

Z_{thjc} = Thermal resistance at time t .

R_i = Amplitude of p_{th} term.

τ_i = Time constant of r_{th} term.

DC Double side cooled

i	1	2	3	4	5	6
R_i , K/W	0.00007989	0.002673	0.0005936	0.000846	0.00005975	0.003948
τ_{i_r} , s	1.688	0.06219	0.002329	0.138	0.0003243	0.9533

DC Cathode side cooled

i	1	2	3	4	5	6
R_i , K/W	0.006619	0.004034	0.0008595	0.002956	0.0005965	0.00005689
τ_{i_r} , s	9.744	1.025	0.1394	0.06237	0.002318	0.0003037

DC Anode side cooled

i	1	2	3	4	5	6
R_i , K/W	0.01013	0.004062	0.0009401	0.002853	0.0005963	0.00005641
τ_{i_r} , s	9.747	1.058	0.1304	0.06179	0.002313	0.0003013

Transient thermal impedance junction to case Z_{thjc} model (see Fig. 2)

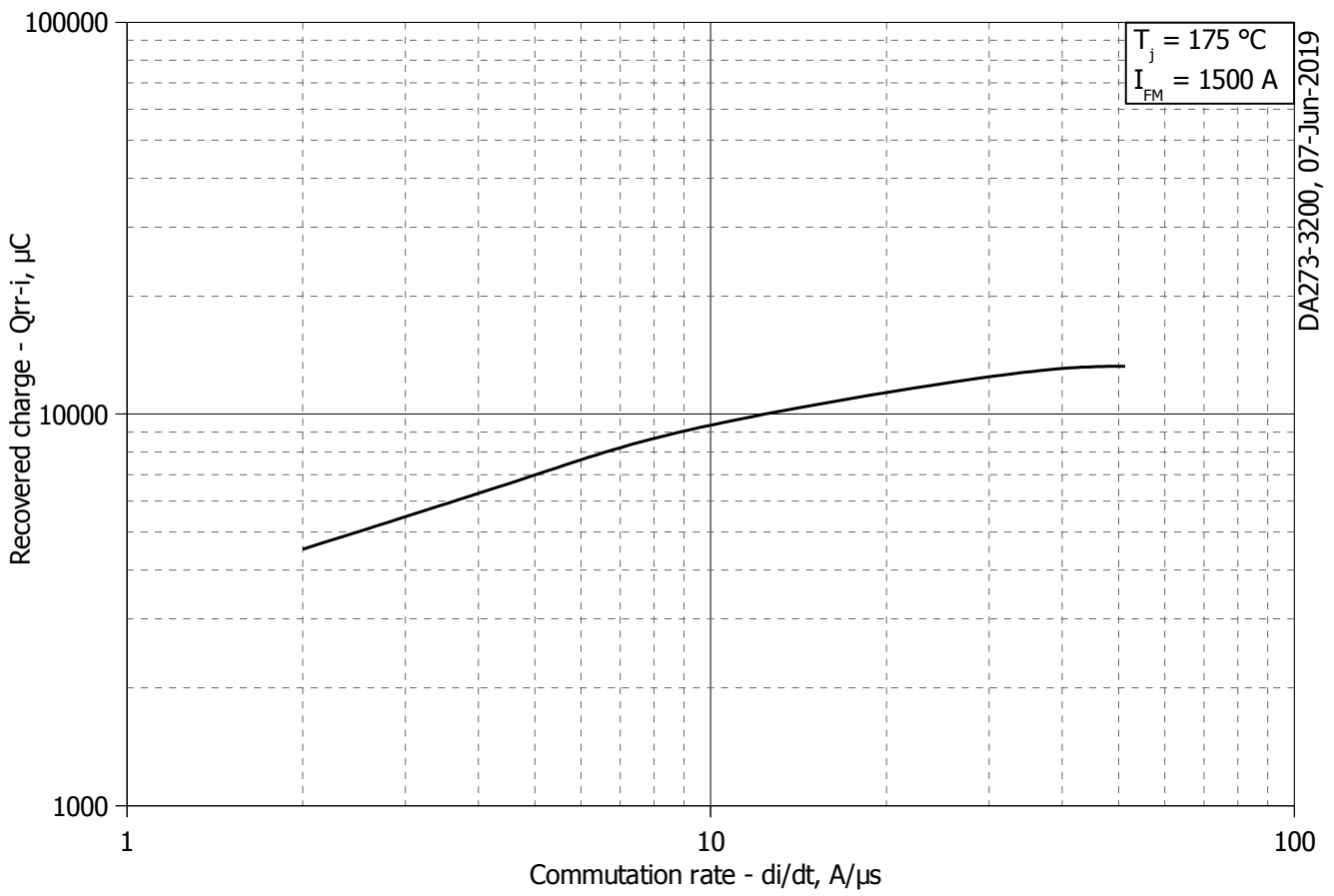

Fig 3 – Maximum recovered charge Q_{rr-i} (integral) vs. commutation rate di_R/dt

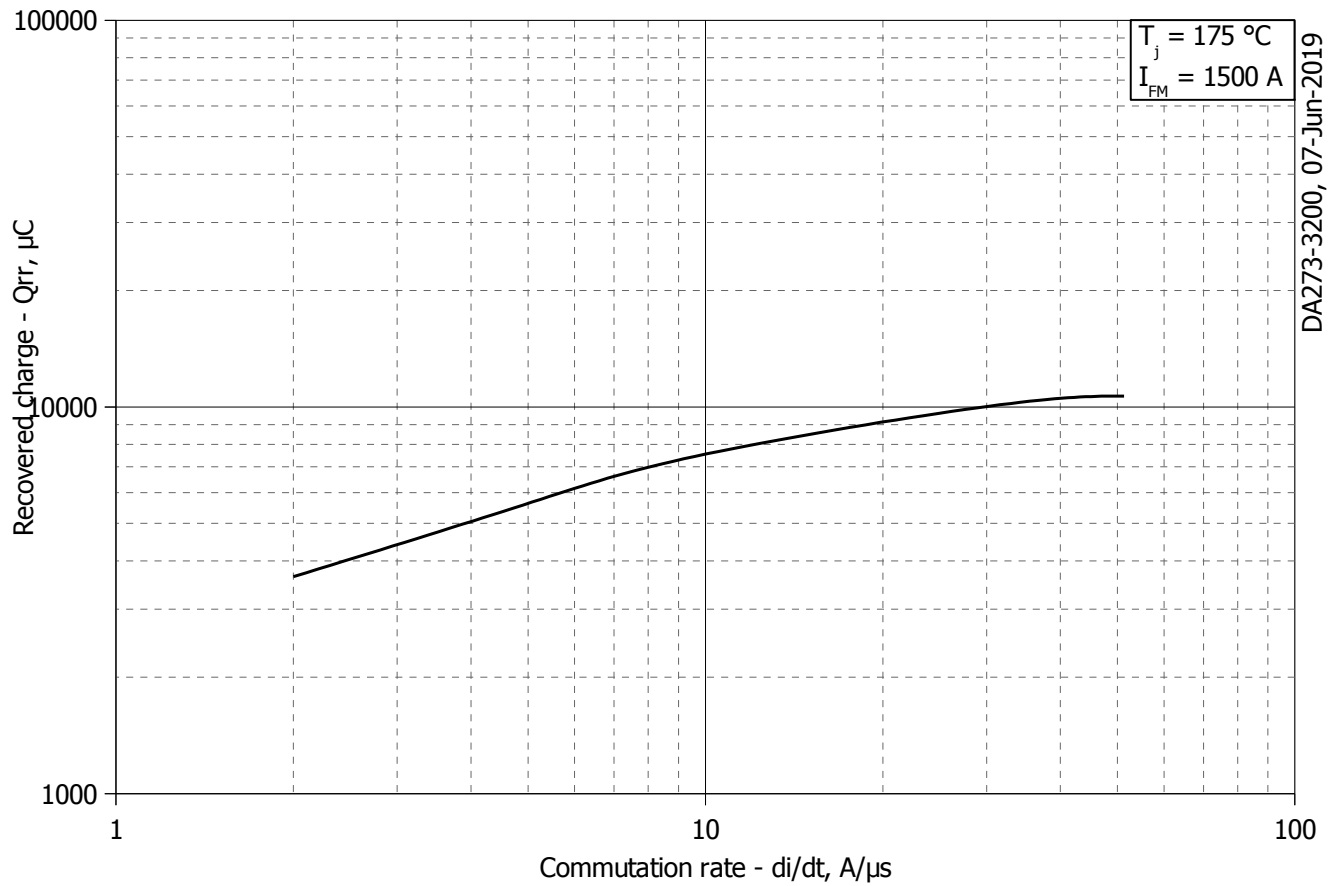

Fig 4 – Maximum recovered charge Q_{rr} vs. commutation rate di_R/dt (25% chord)

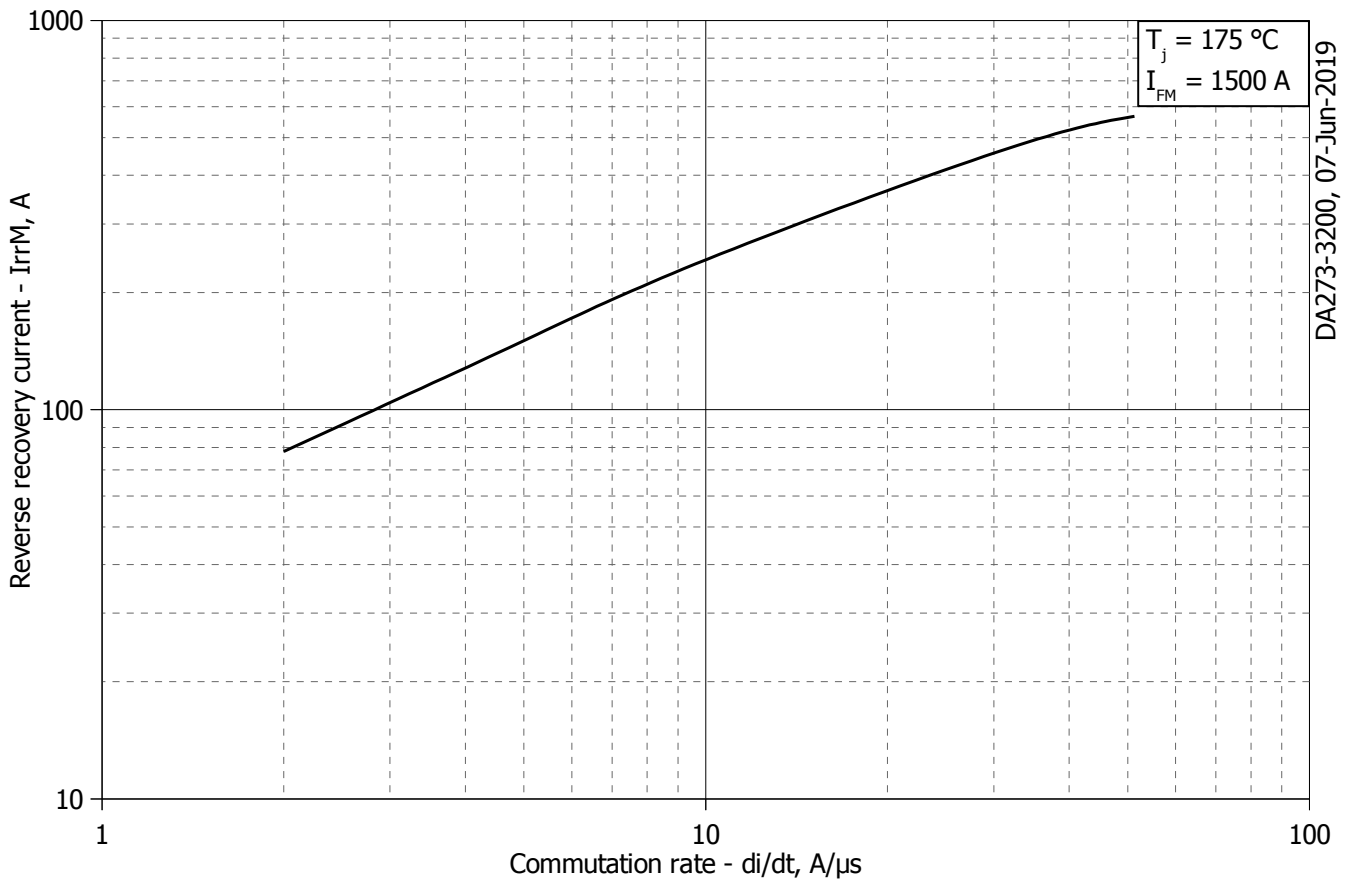

Fig 5 – Maximum reverse recovery current I_{rrM} vs. commutation rate di_R/dt

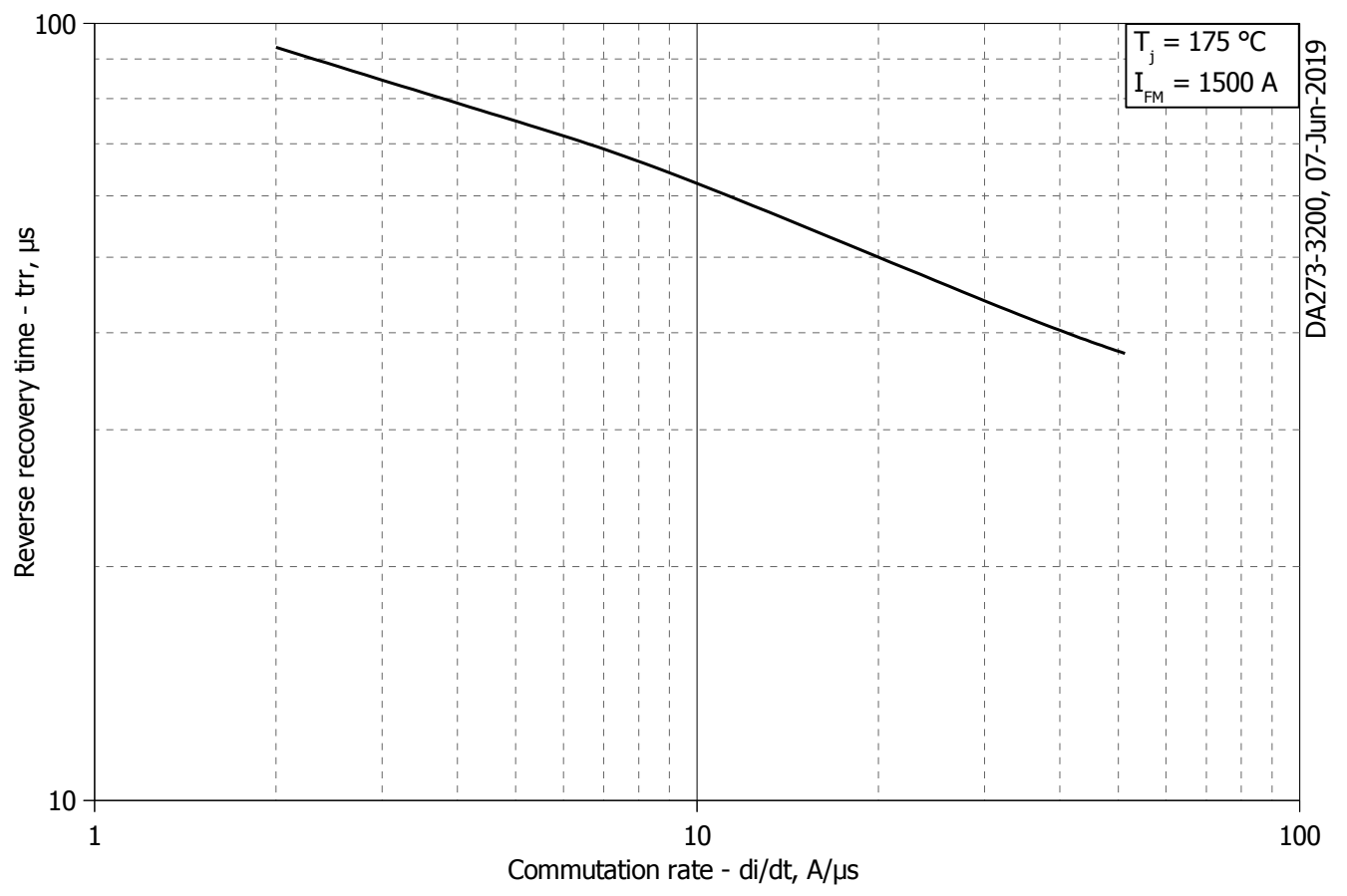

Fig 6 – Maximum recovery time t_{rr} vs. commutation rate di_R/dt (25% chord)

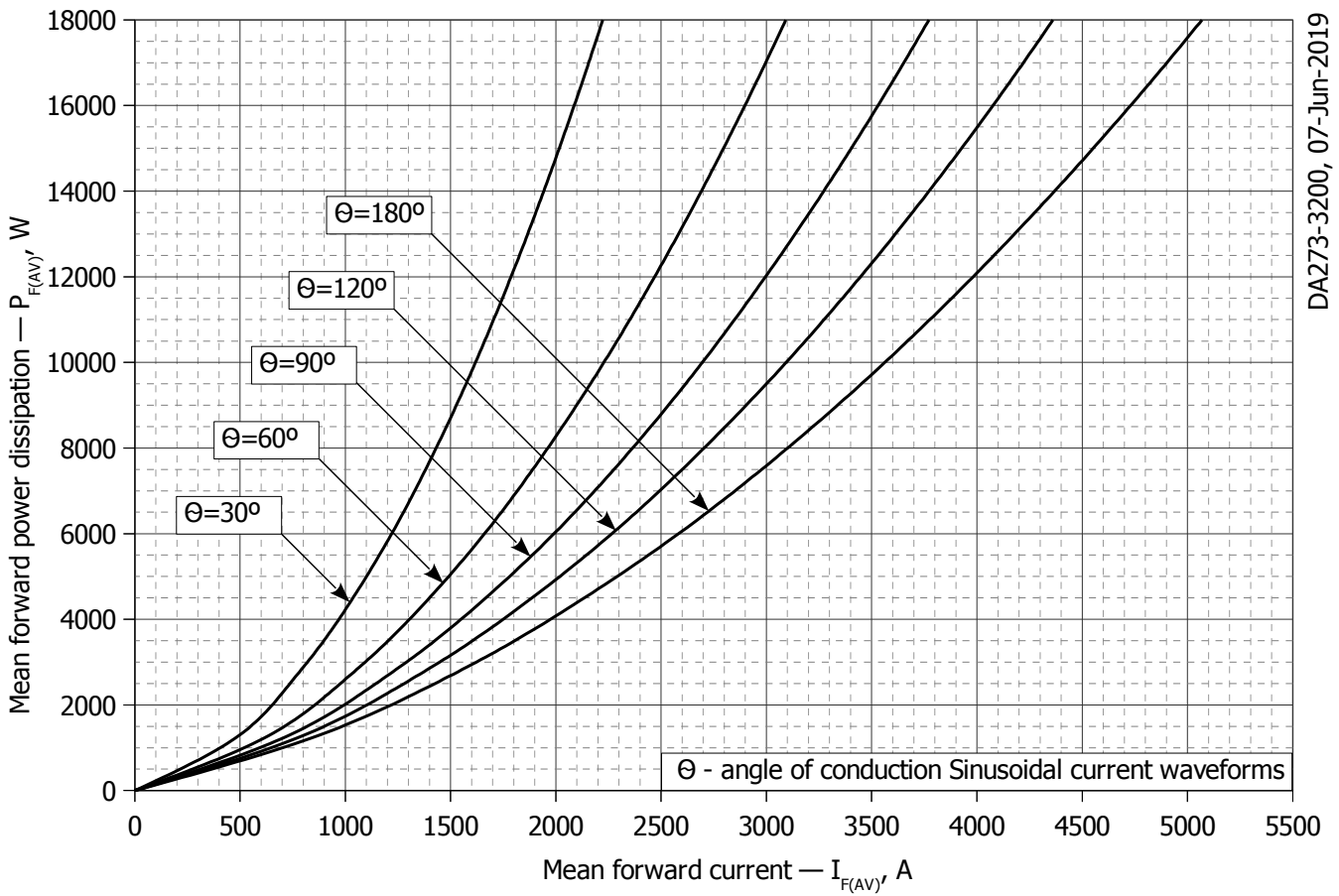

Fig. 7 - Mean forward power dissipation P_{FAV} vs. mean forward current I_{FAV} for sinusoidal current waveforms at different conduction angles (f=50Hz, DSC)

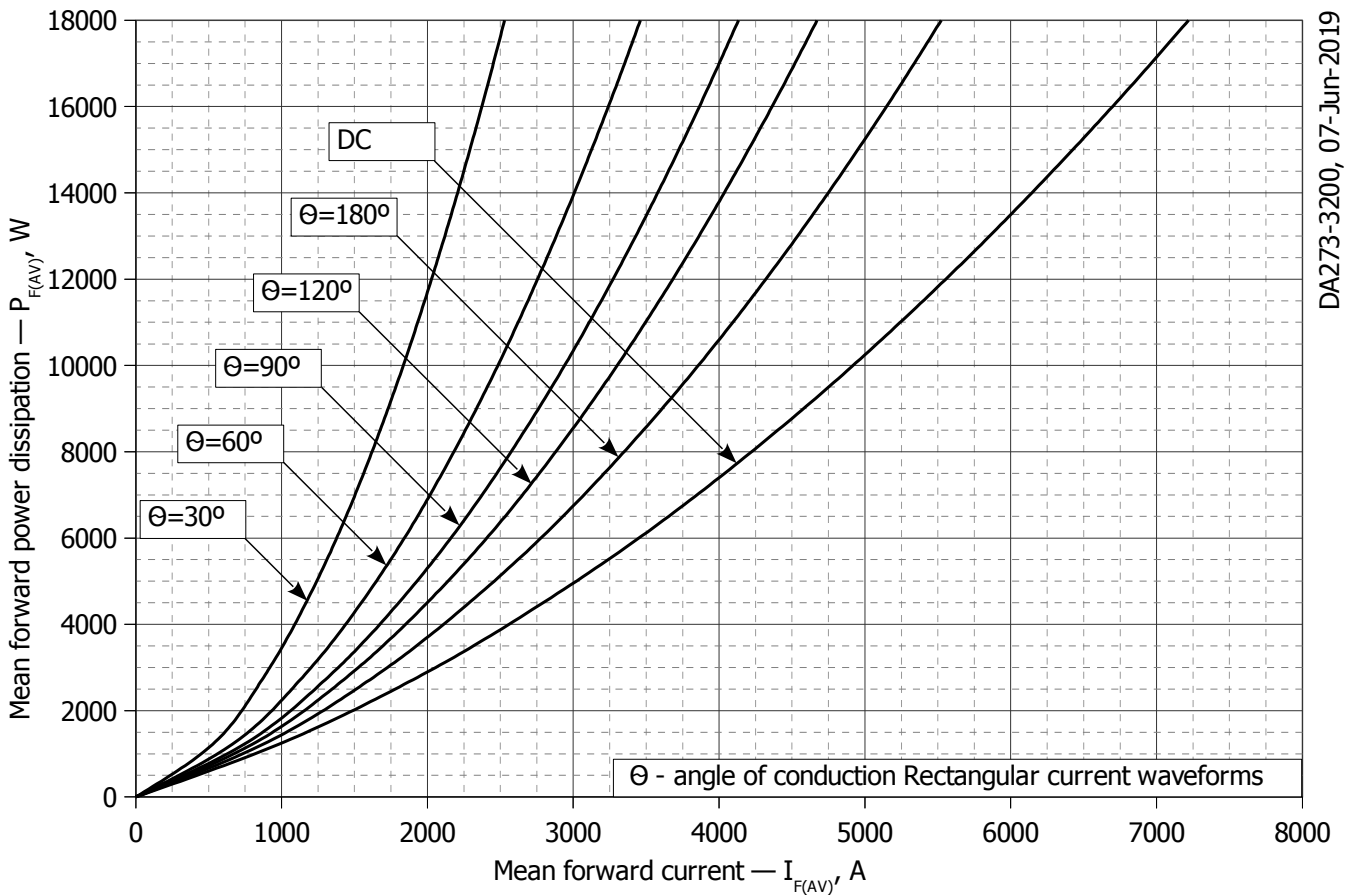

Fig. 8 - Mean forward power dissipation P_{FAV} vs. mean forward current I_{FAV} for rectangular current waveforms at different conduction angles and for DC (f=50Hz, DSC)

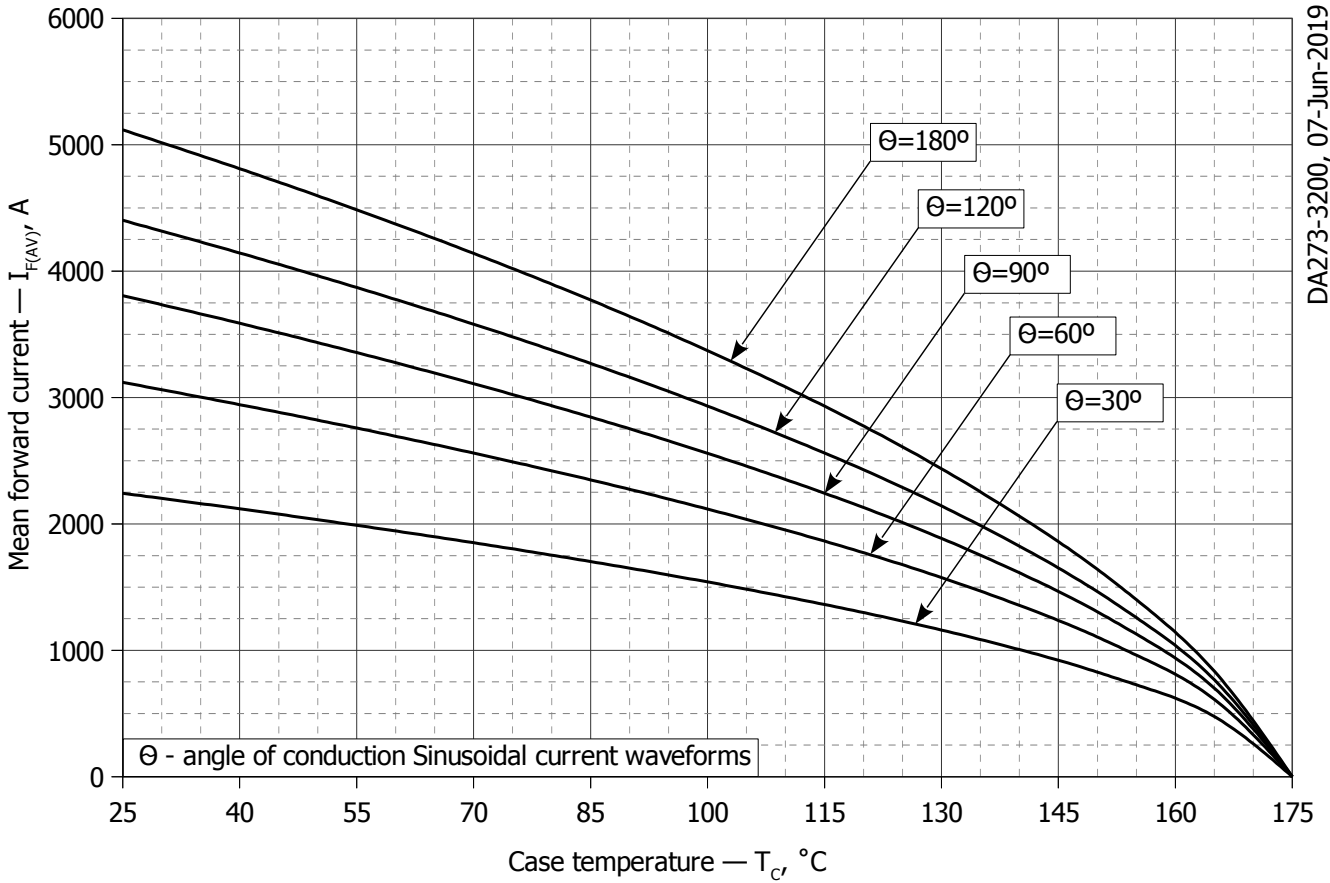

Fig. 9 – Mean forward current I_{FAV} vs. case temperature T_c for sinusoidal current waveforms at different conduction angles ($f=50\text{Hz}$, DSC)

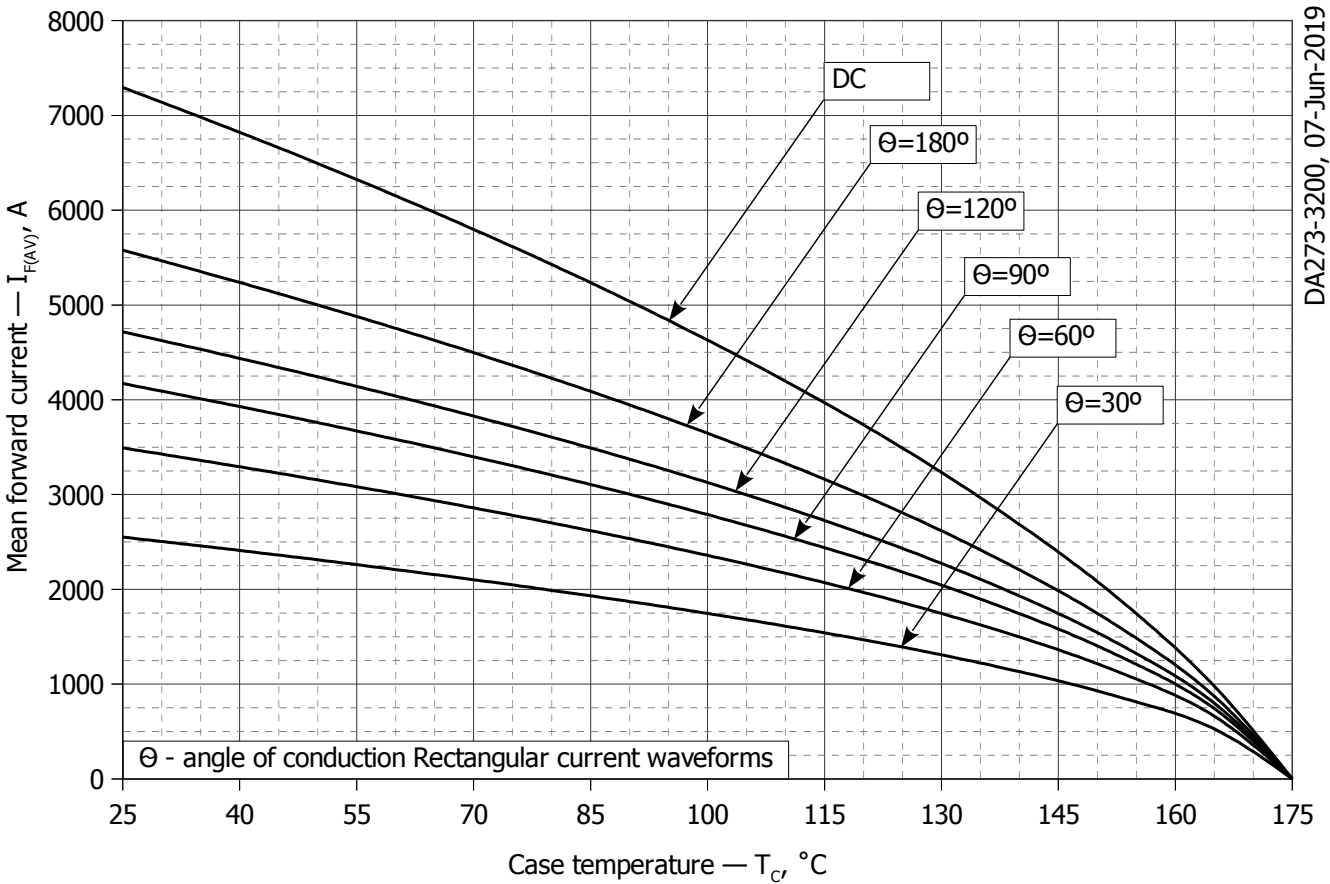

Fig. 10 - Mean forward current I_{FAV} vs. case temperature T_c for rectangular current waveforms at different conduction angles and for DC ($f=50\text{Hz}$, DSC)

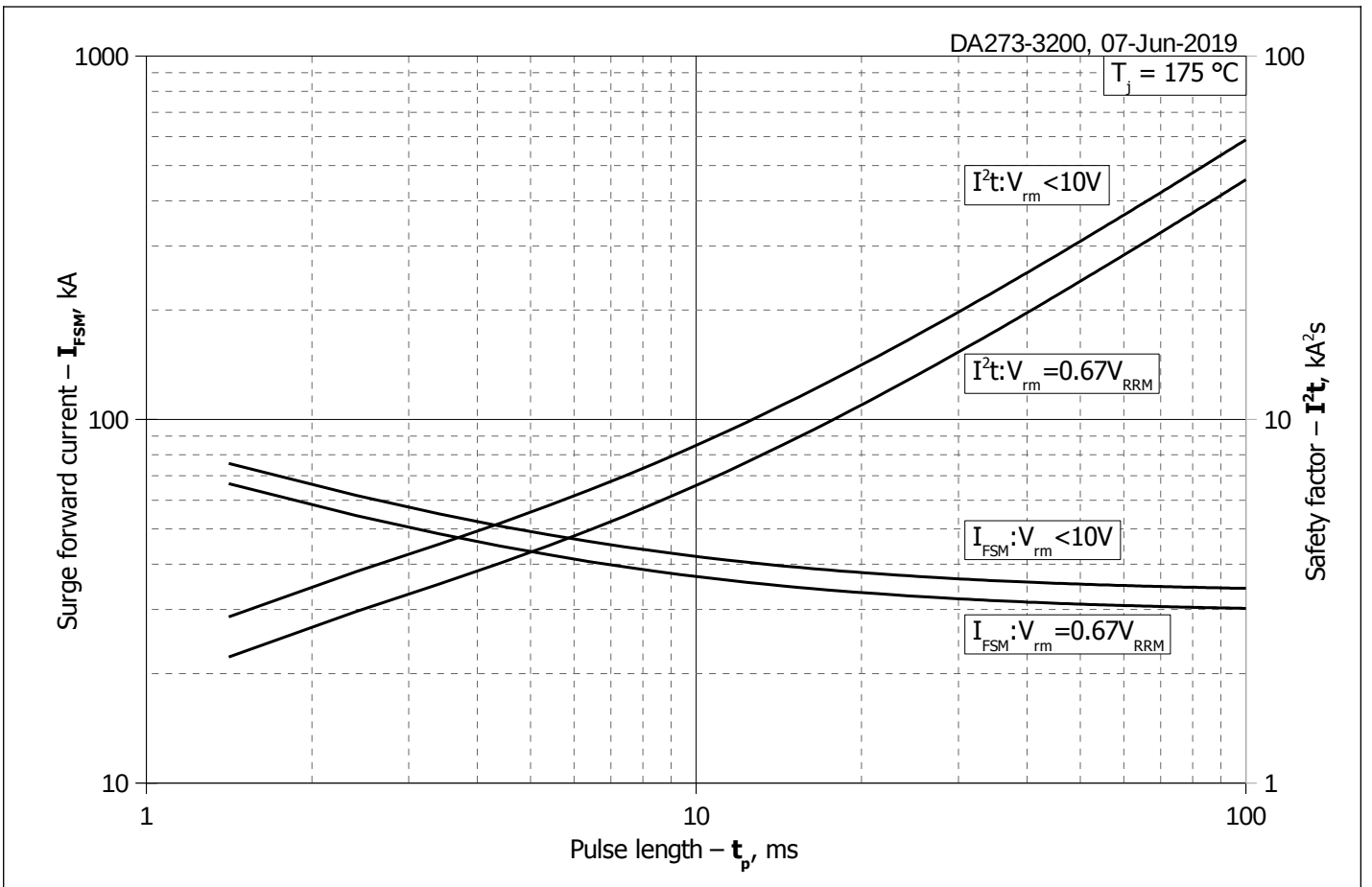

Fig. 11 – Maximum surge forward current I_{FSM} and safety factor I^2t vs. pulse length t_p

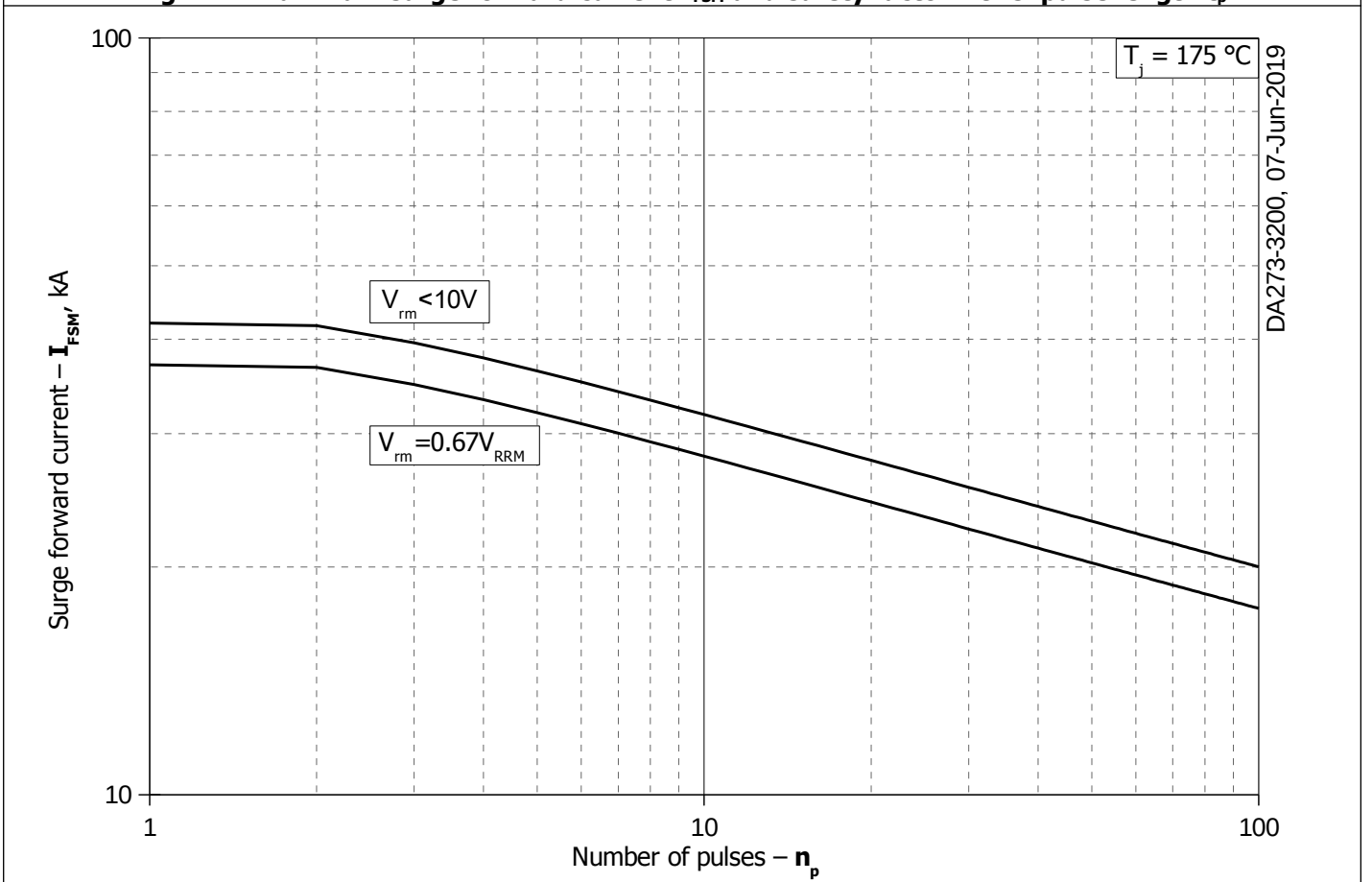

Fig. 12 - Maximum surge forward current I_{FSM} vs. number of pulses n_p