

### Low Inductance IGBT Module with 17 mm Height Housing

1200 V 300 A

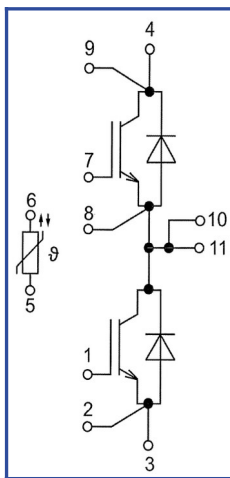
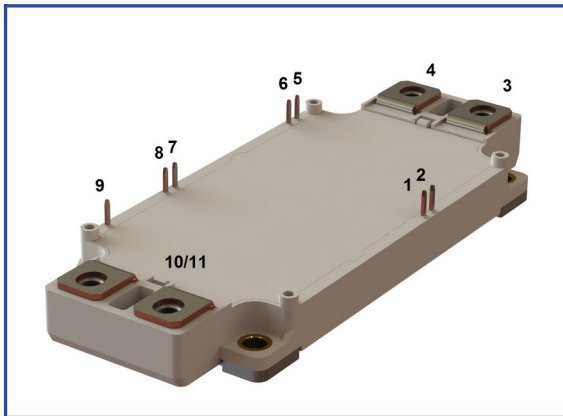

#### Chip features

- IGBT chip
  - Trench FS
  - low  $V_{CE(sat)}$  value
  - 10  $\mu$ s short circuit duration at 150°C
  - square RBSOA of 2xlc
  - low EMI
- FRD chip
  - fast and soft reverse recovery
  - low voltage drop

#### Design features

- copper baseplate
- $Al_2O_3$  DBC substrate
- ultrasonic welded power terminals
- improved thermal cycling
- RoHS compliant

#### Typical application

- AC motor drives
- solar inverters
- air conditioning
- high power converters and UPS
- Inverters for wind energy converters

### Maximum rated values

Definition	Symbol	Conditions	Value	Unit
<b>IGBT</b>				
Collector-Emitter voltage	$V_{CES}$	$V_{GE} = 0$ .	1200	V
Collector current (nominal)	$I_{C\ nom}$		300	A
Collector current (maximum continuous)	$I_{C\ 25}$	$T_{vj\ (max)} = 175^{\circ}C; T_c = 25^{\circ}C$ .	442	A
	$I_{C\ 80}$	$T_{vj\ (max)} = 175^{\circ}C; T_c = 80^{\circ}C$ .	300	A
Repetitive peak collector current*1	$I_{CRM}$	$I_{CRM} = 3 \times I_{C\ nom}; t_p = 1\ ms$ .	900	A
Short-circuit duration	$t_{psc}$	$T_{vj} = 25^{\circ}C; V_{GE} = \pm 15\ V; V_{CE} = 720\ V;$ $R_{G\ on} = R_{G\ off} = 1.5\ \Omega$	10	$\mu$ s
		$T_{vj} = 150^{\circ}C; V_{GE} = \pm 15\ V; V_{CE} = 720\ V;$ $R_{G\ on} = R_{G\ off} = 1.5\ \Omega$	10	
Gate-Emitter voltage	$V_{GES}$		$\pm 20$	V
Junction operating temperature	$T_{vj\ (op)}$		-40...+150	$^{\circ}C$
<b>Inverse diode</b>				
Repetitive peak reverse voltage	$V_{RRM}$	$V_{GE} = 0\ V$ .	1200	V
Forward current (nominal)	$I_{F\ nom}$		300	A
Forward current (maximum continuous)	$I_{F\ 25}$	$T_{vj\ (max)} = 175^{\circ}C; T_c = 25^{\circ}C$ .	402	A
	$I_{F\ 80}$	$T_{vj\ (max)} = 175^{\circ}C; T_c = 80^{\circ}C$ .	304	A
Repetitive peak forward current*1	$I_{FRM}$	$I_{FRM} = 3 \times I_{F\ nom}; t_p = 1\ ms$ .	900	A
Junction operating temperature	$T_{vj\ (op)}$		-40...+150	$^{\circ}C$
<b>Module</b>				
Storage temperature	$T_{stg}$		-55...+50	$^{\circ}C$
Isolation voltage	$V_{isol}$	AC sin 50 Hz; t = 1 min.	4000	V

\*1 Pulse width and repetition rate should be such that device junction temperature does not exceed maximum  $T_{vj}$  rating

### Characteristics

Definition	Symbol	Conditions	Value			Unit		
			min.	typ.	max.			
<b>IGBT</b>								
Collector-Emitter saturation voltage	$V_{CEsat}$	$V_{GE} = +15\text{ V}; I_C = 300\text{ A}; t_u = 1000\ \mu\text{s}.$	$T_{vj} = 25^\circ\text{C}$ $T_{vj} = 150^\circ\text{C}$	1.92 2.42	1.94 2.47	2.08 2.65	V V	
Gate-Emitter threshold voltage	$V_{GE(th)}$	$I_C = 12\text{ mA}; V_{CE} = V_{GE}; T_{vj} = 25^\circ\text{C}; t_u = 2\text{ ms}.$		5.50	5.82	6.20	V	
Collector-Emitter cut-off current	$I_{CES}$	$V_{CE} = 1200\text{ V}; t_u = 50\text{ ms}; V_{GE} = 0.$	$T_{vj} = 25^\circ\text{C}$ $T_{vj} = 150^\circ\text{C}$	1.76 1.19	2.31 1.30	300 5.00	$\mu\text{A}$ mA	
Gate-Emitter leakage current	$I_{GES}$	$V_{CE} = 0; V_{GE} = \pm 20\text{ V}; T_{vj} = 25^\circ\text{C}; t_u = 30\text{ ms}.$		10.4	13.8	400	nA	
Input capacitance	$C_{ies}$	$V_{CE} = 10\text{ V}; V_{GE} = 0\text{ V}; f = 1\text{ MHz}; T_{vj} = 25^\circ\text{C}.$		-	27.3	-	nF	
Output capacitance	$C_{oes}$		-	-	2.1	-	nF	
Reverse transfer capacitance	$C_{res}$		-	-	2.4	-	nF	
Total gate charge	$Q_G$	$I_C = 300\text{ A}; V_{CE} = 600\text{ V}; V_{GE} = -8 \div 15\text{ V}.$		-	2880	3000	nC	
Internal gate resistance	$R_{Gint}$	$T_{vj} = 25^\circ\text{C}.$		-	2.5	-	$\Omega$	
Turn-on delay time	$t_{d(on)}$	$V_{CE} = 600\text{ V}; V_{GE} = \pm 15\text{ V}; I_{Cmax} = 300\text{ A}; R_G = 1.5\ \Omega; L = 56\text{ nH}.$	$T_{vj} = 25^\circ\text{C}$ $T_{vj} = 150^\circ\text{C}$	376 416	384 420	430 460	ns	
Rise time	$t_{ri}$		$T_{vj} = 25^\circ\text{C}$ $T_{vj} = 150^\circ\text{C}$	60 66	60 66	70 75	ns	
Turn-on energy	$E_{on}$		$T_{vj} = 25^\circ\text{C}$ $T_{vj} = 150^\circ\text{C}$	7 15	8 16	11 19.5	mJ	
Turn-off delay time	$t_{d(off)}$		$T_{vj} = 25^\circ\text{C}$ $T_{vj} = 150^\circ\text{C}$	490 580	510 600	570 680	ns	
Fall time	$t_{fi}$		$T_{vj} = 25^\circ\text{C}$ $T_{vj} = 150^\circ\text{C}$	224 300	232 308	260 350	ns	
Turn-off energy	$E_{off}$		$T_{vj} = 25^\circ\text{C}$ $T_{vj} = 150^\circ\text{C}$	27 36	29 38	34 45	mJ	
Collector-emitter threshold voltage	$V_{CE0}$		$V_{GE} = +15\text{ V}; T_{vj} = 150^\circ\text{C}; I_{CE1} = 75\text{ A}; I_{CE2} = 300\text{ A}; t_u = 1000\ \mu\text{s}.$		0.859	0.866	0.900	V
On-State slope resistance (IGBT)	$r_{CE0}$				5.16	5.33	5.63	m $\Omega$
Thermal resistance junction to case	$R_{th(j-c)}$		DC; $I_{test} = 1.5\text{ A}; V_{GE} = +15\text{ V}.$		-	0.0927	0.100	K/W
<b>Inverse diode</b>								
Forward voltage drop	$V_F$	$I_F = 300\text{ A}; V_{GE} = 0; t_u = 1000\ \mu\text{s}.$	$T_{vj} = 25^\circ\text{C}$ $T_{vj} = 150^\circ\text{C}$	1.90 2.06	1.96 2.13	2.14 2.34	V V	
Reverse recovery time	$t_{rr}$	$V_{GE} = \pm 15\text{ V}; V_{CE} = 600\text{ V}; I_{Cmax} = 300\text{ A}; R_{Gon} = 1.5\ \Omega; L = 56\text{ nH}.$	$T_{vj} = 25^\circ\text{C}$ $T_{vj} = 150^\circ\text{C}$	122 179	128 188	150 220	ns ns	
Repetitive peak reverse current	$I_{rrm}$		$T_{vj} = 25^\circ\text{C}$ $T_{vj} = 150^\circ\text{C}$	235 292	243 299	270 330	A A	
Reverse recovered charge	$Q_{rr}$		$T_{vj} = 25^\circ\text{C}$ $T_{vj} = 150^\circ\text{C}$	17 31	18 32	21 36	$\mu\text{C}$ $\mu\text{C}$	
Reverse recovery energy	$E_{rec}$		$T_{vj} = 25^\circ\text{C}$ $T_{vj} = 150^\circ\text{C}$	10 24	10 25	13 29	mJ mJ	
Threshold voltage	$V_{(T0)}$		$T_{vj} = 150^\circ\text{C}; V_{GE} = 0; t_u = 1000\ \mu\text{s}$		0.831	0.843	0.890	V
Forward slope resistance	$r_T$				4.09	4.30	4.67	m $\Omega$
Thermal resistance junction to case	$R_{th(jc-D)}$	DC; $I_{test} = 1.5\text{ A}; V_{GE} = +15\text{ V}.$		-	0.128	0.135	K/W	

# MIDA-HB12FA-300N

## IGBT module datasheet

Module							
Pin resistance	$R_{Pxy}$	$T_{vj} = 25^{\circ}\text{C}$	$R_{P10/11-3}$	-	0.92	1.00	m $\Omega$
			$R_{P10/11-4}$	-	0.59	1.00	
Parasitic inductance between terminals	$L_{Pce}$			-	22	-	nH
Thermistor resistance	$R_{t25}$	$T_{vj} = 25^{\circ}\text{C}$ $T_{vj} = 100^{\circ}\text{C}$		-	5000	-	$\Omega$
				-	495	-	
Coefficient of temperature sensitivity	$B_{25/50}$	$R_2 = R_{25} \exp [B_{25/50} (1/T_2 - 1/T_1)],$ $T_1 = 298.15 \text{ K}$		-	3375	-	K
Thermal resistance case to heatsink	$R_{thCH}$	per module		-	0.009	0.014	K/W
Mounting torque for screws to heatsink	$M_s$	to heatsink M5		3	-	6	N*m
Mounting torque for terminal screws	$M_t$	to terminals M6		3	-	6	N*m
Weight	$W$			-	360	-	g

### Notes:

- Insulating material operating temperature 125°C max;
- Case temperature 125°C max;
- The recommended operating junction temperature  $T_{vj\text{ op}} = -40 \div +150^{\circ}\text{C}$ .

Chart 1 – typ. output characteristic, IGBT.

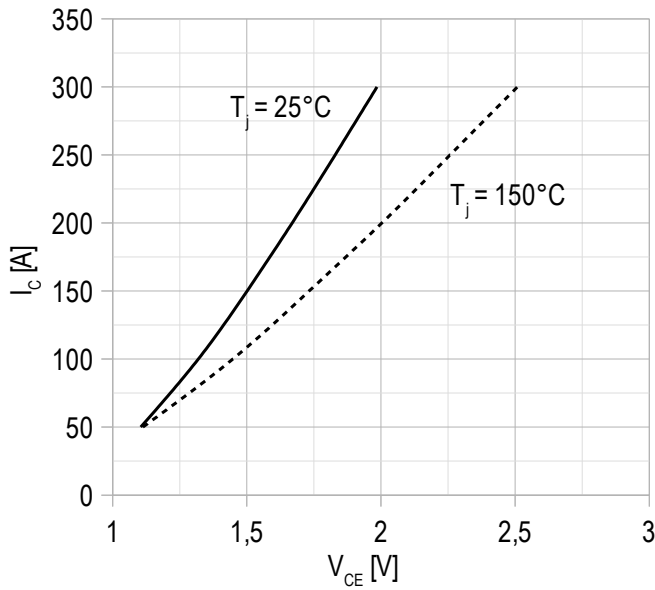

$V_{GE} = +15\text{ V}$ .

Chart 2 – max. rated current vs temperature.

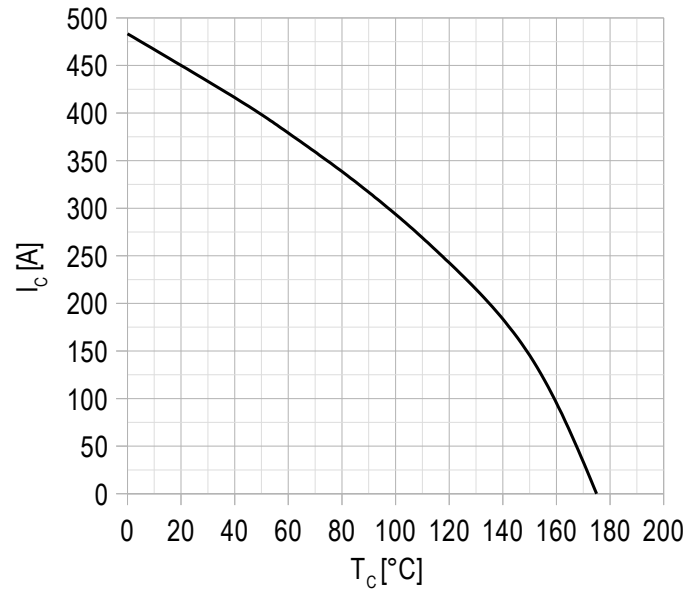

DC;  
 $V_{GE} = +15\text{ V}$ ;  
 $T_{vj(max)} = 150^\circ\text{C}$ .

Chart 3 – typ. turn-on/off energy vs rated current, IGBT.

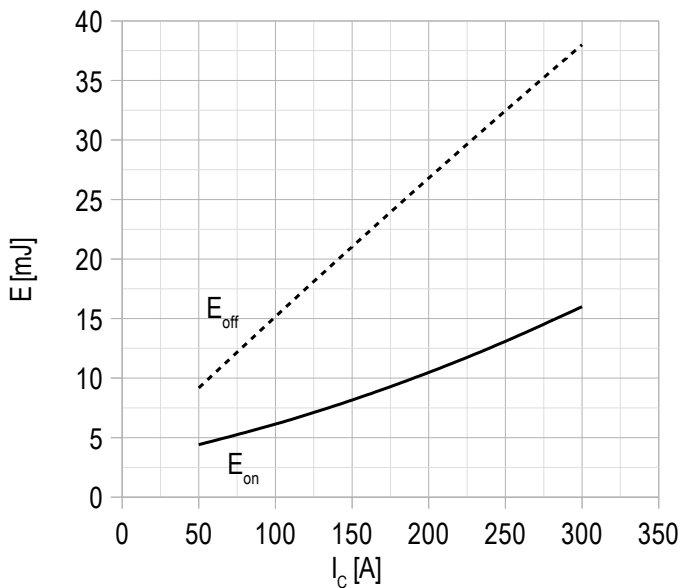

$V_{CE} = 600\text{ V}$ ;  
 $V_{GE} = \pm 15\text{ V}$ ;  
 $R_G = 1.5\ \Omega$ ;  
 $L = 56\text{ nH}$ ;  
 $T_{vj(max)} = 150^\circ\text{C}$ .

Chart 4 – typ. turn-on/off energy vs gate resistance, IGBT.

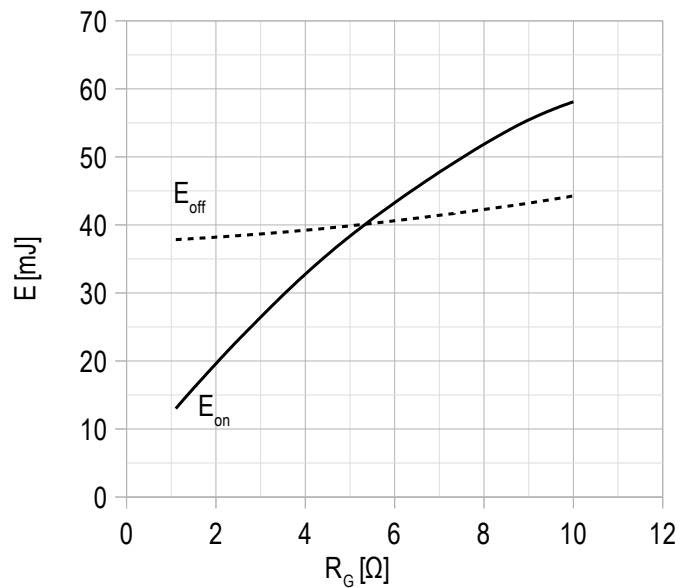

$V_{CE} = 600\text{ V}$ ;  
 $V_{GE} = \pm 15\text{ V}$ ;  
 $I_{Cmax} = 300\text{ A}$ ;  
 $L = 56\text{ nH}$ ;  
 $T_{vj(max)} = 150^\circ\text{C}$ .

Chart 5 – typ. switching times vs rated current, IGBT.

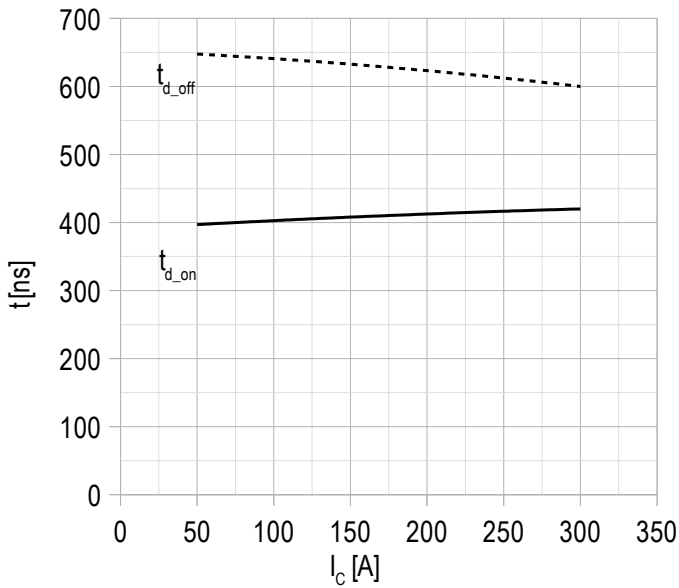

$V_{CE} = 600$  V;  
 $V_{GE} = \pm 15$  V;  
 $R_G = 1.5$   $\Omega$ ;  
 $L = 56$  nH;  
 $T_{vj(max)} = 150^\circ\text{C}$ .

Chart 6 – typ. switching times vs gate resistance, IGBT.

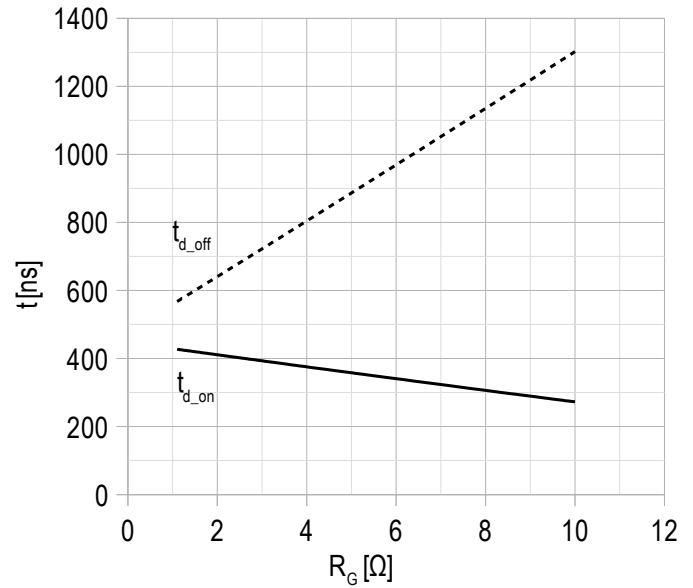

$V_{CE} = 600$  V;  
 $V_{GE} = \pm 15$  V;  
 $I_{Cmax} = 300$  A;  
 $L = 56$  nH;  
 $T_{vj(max)} = 150^\circ\text{C}$ .

Chart 7 – typ. switching times vs rated current, IGBT.

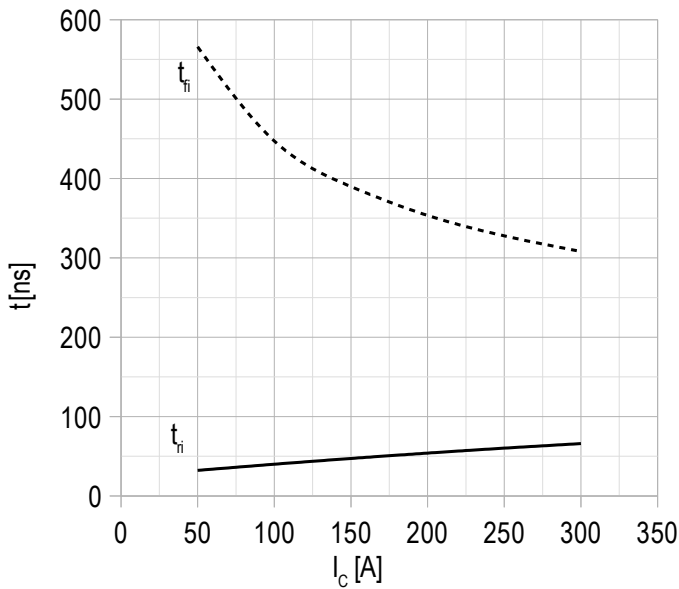

$V_{CE} = 600$  V;  
 $V_{GE} = \pm 15$  V;  
 $R_G = 1.5$   $\Omega$ ;  
 $L = 56$  nH.  
 $T_{vj(max)} = 150^\circ\text{C}$ .

Chart 8 – typ. switching times vs gate resistance, IGBT.

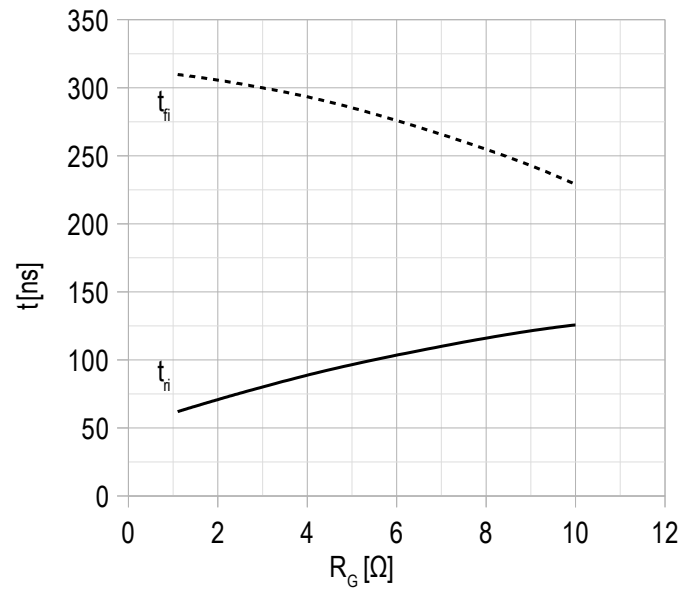

$V_{CE} = 600$  V;  
 $V_{GE} = \pm 15$  V;  
 $I_{Cmax} = 300$  A;  
 $L = 56$  nH.  
 $T_{vj(max)} = 150^\circ\text{C}$ .

Chart 9 – max. transient thermal impedance.

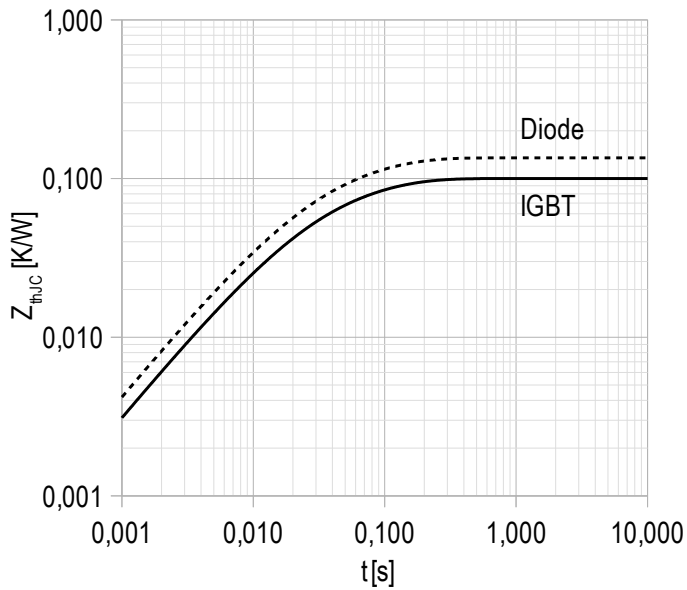

Single pulse;  
 $V_{GE} = +15\text{ V}$ .

Chart 10 – RBSOA.

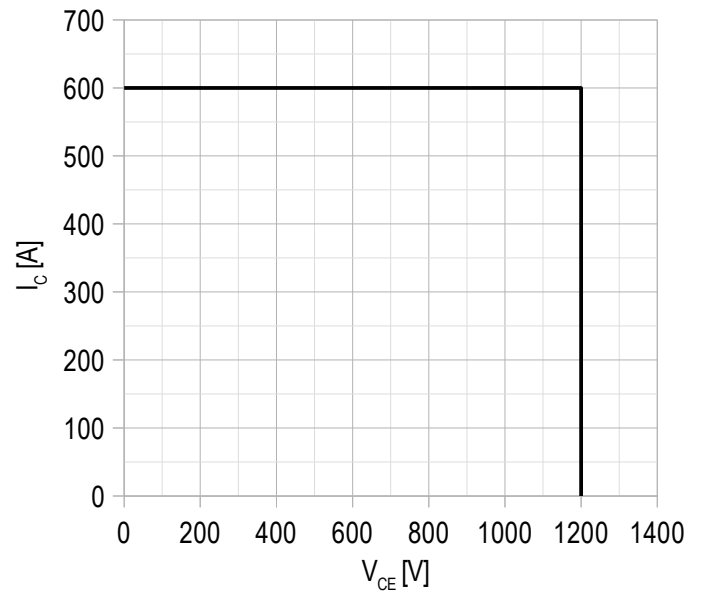

$V_{CE\text{ max}} = 1200\text{ V}$ ;  
 $V_{GE} = \pm 15\text{ V}$ ;  
 $I_{C\text{ max}} = 2 \cdot I_{C\text{ nom}}$ ;  
 $R_G = 1.5\ \Omega$ ;  
 $L = 56\text{ nH}$ .

Chart 11 – typ. output characteristic, FRD.

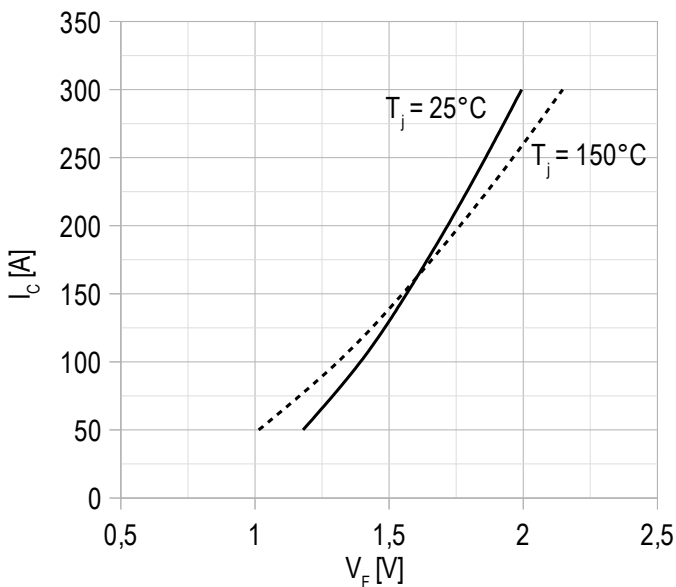

$V_{GE} = 0\text{ V}$ .

Chart 12 – typ. switching losses vs rated current, FRD.

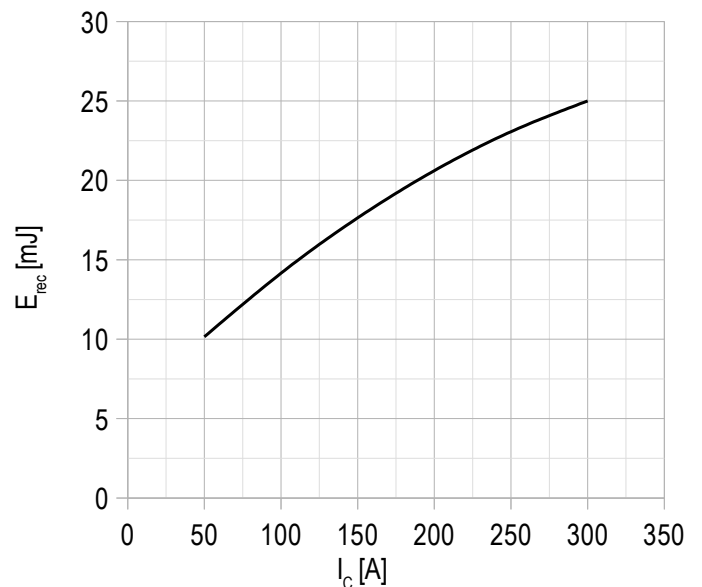

$V_{GE} = \pm 15\text{ V}$ ;  
 $V_{CE} = 600\text{ V}$ ;  
 $L = 56\text{ nH}$ ;  
 $R_{G\text{ on}} = 1.5\ \Omega$ ;  
 $T_{vj\text{ (max)}} = 150^\circ\text{C}$ .

Chart 13 – typ. switching losses vs gate resistance, FRD.

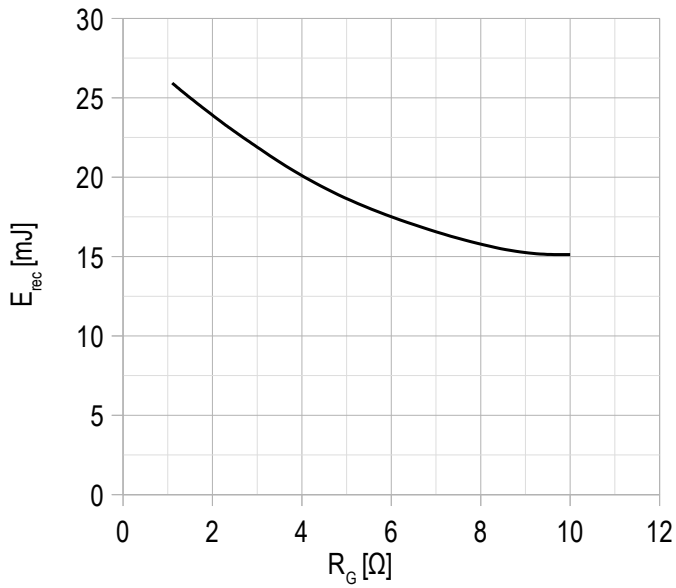

$V_{GE} = \pm 15$  V;  
 $V_{CE} = 600$  V;  
 $I_{C\ max} = 300$  A;  
 $L = 56$  nH;  
 $T_{vj\ (max)} = 150^\circ\text{C}$ .

Chart 14 – typ. reverse recovered charge vs gate resistance, FRD.

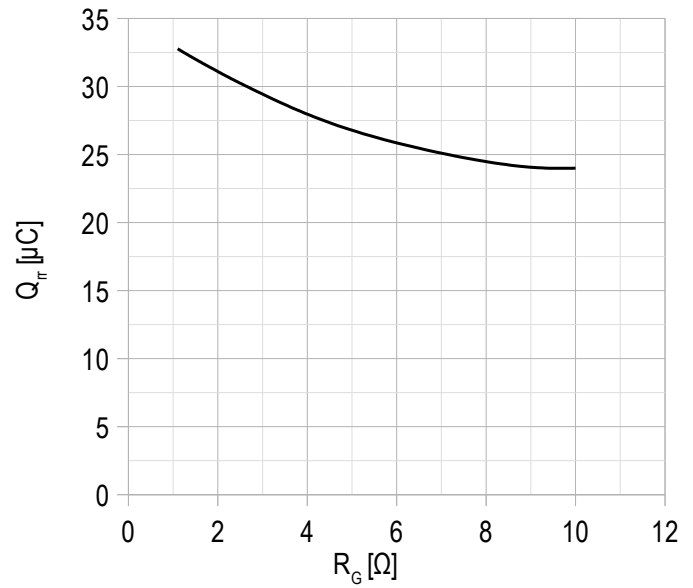

$V_{GE} = \pm 15$  V;  
 $V_{CE} = 600$  V;  
 $I_{C\ max} = 300$  A;  
 $L = 56$  nH;  
 $T_{vj\ (max)} = 150^\circ\text{C}$ .

Chart 15 – typ. gate charge characteristic.

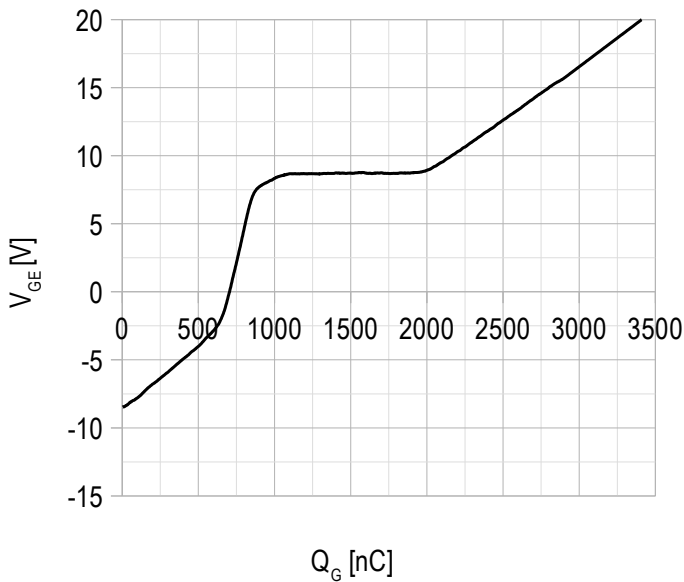

$I_C = 300$  A;  
 $V_{CE} = 600$  V;  
 $V_{GE} = -8 \div 15$  V.

Chart 16 – typ. reverse recovery current vs gate resistance FRD.

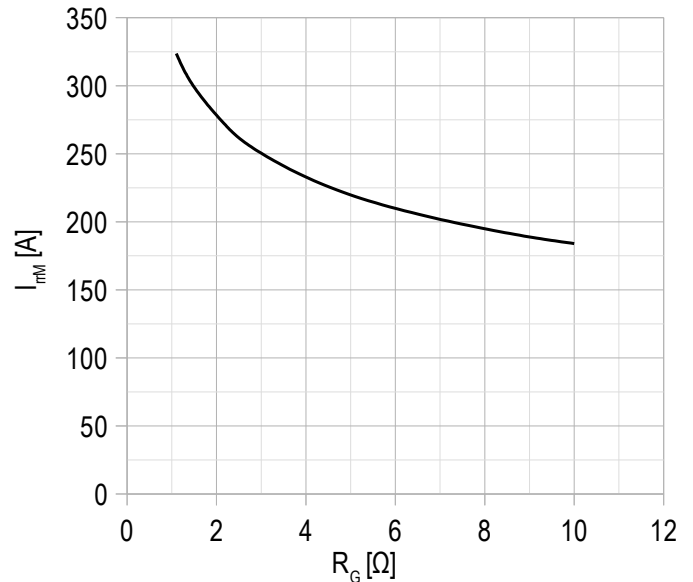

$V_{CE} = 600$  V;  
 $V_{GE} = \pm 15$  V;  
 $L = 56$  nH;  
 $T_{vj\ (max)} = 150^\circ\text{C}$ .

Chart 17 – max. rated current vs frequency.

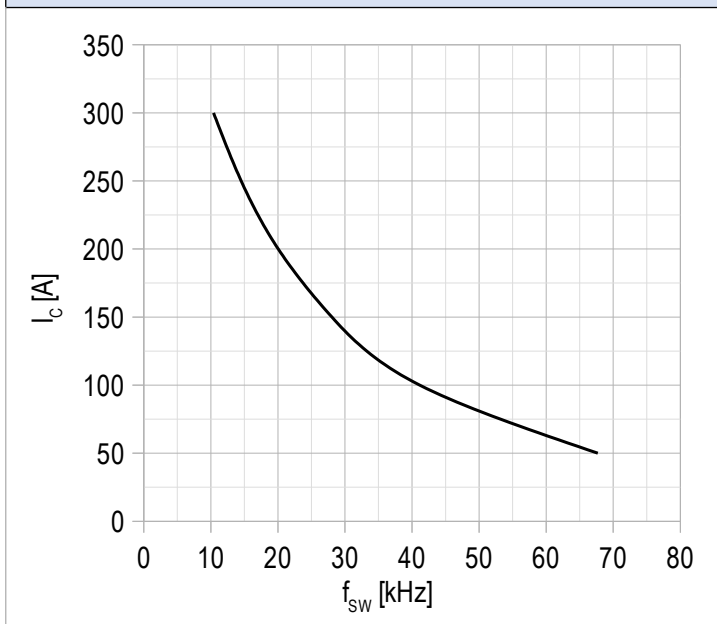

Duty cycle 50%;  
 $V_{CE} = 600$  V;  
 $T_c = 80$  °C;  
 $T_{vj(max)} = 175$  °C.



# MIDA-HB12FA-300N

IGBT module datasheet

## Overall dimensions: Package type – DA

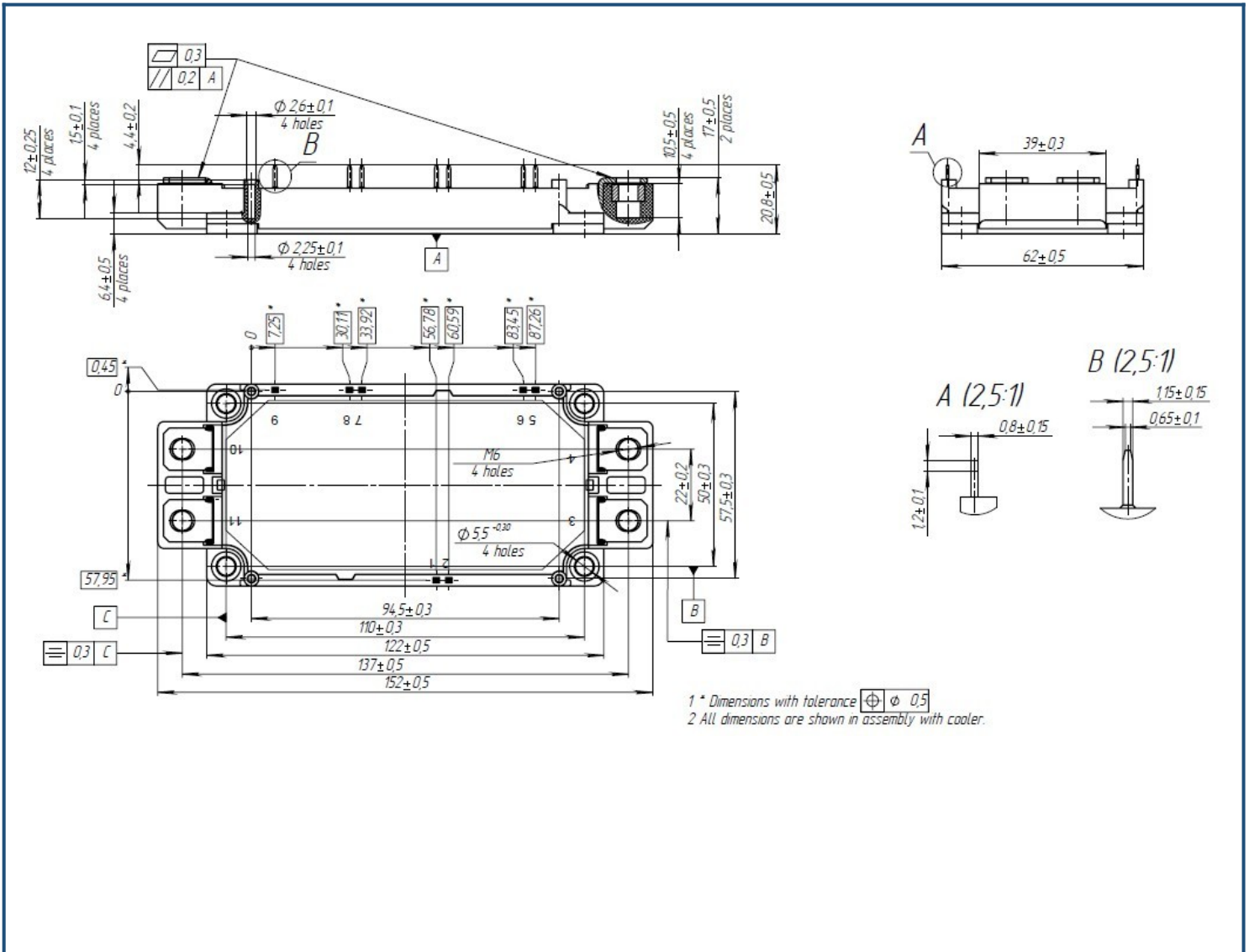

## Part numbering guide

MIDA	-	HB	12	FA	-	300	N	
MIDA								IGBT module package type: DA
		HB						Half-Bridge
			12					Voltage rating (V <sub>CES</sub> /100)
				FA				IGBT+FRD chipset modification
						300		Current Rating
							N	Climatic version: normal climate

The information contained herein is protected by Copyright. In the interest of product improvement, Proton-Electrotex reserves the right to change datasheet without notice.