

High power cycling capability
 Low on-state and switching losses
 Optimized for line frequency rectifiers
 Designed for traction and industrial applications

Rectifier Diode Type D173-4000-28

Average forward current		I_{FAV}		4000 A	
Repetitive peak reverse voltage		V_{RRM}		2000 ÷ 2800 V	
V_{RRM}, V	2000	2200	2400	2600	2800
Voltage code	20	22	24	26	28
$T_j, ^\circ C$	-60 ÷ 175				

MAXIMUM ALLOWABLE RATINGS

Symbols and parameters		Units	Values	Test conditions	
ON-STATE					
I_{FAV}	Average forward current	A	4000 5239	$T_c=124^\circ C$; Double side cooled; $T_c=100^\circ C$; Double side cooled; 180° half-sine wave; 50 Hz	
I_{FRMS}	RMS forward current	A	6280	$T_c=124^\circ C$; Double side cooled; 180° half-sine wave; 50 Hz	
I_{FSM}	Surge forward current	kA	55.0 63.0	$T_j=T_{jmax}$ $T_j=25^\circ C$	180° half-sine wave; 50 Hz ($t_p=10$ ms); single pulse; $V_R=0$ V;
			58.0 67.0	$T_j=T_{jmax}$ $T_j=25^\circ C$	180° half-sine wave; 60 Hz ($t_p=8.3$ ms); single pulse; $V_R=0$ V;
I^2t	Safety factor	$A^2s \cdot 10^3$	15125 19845	$T_j=T_{jmax}$ $T_j=25^\circ C$	180° half-sine wave; 50 Hz ($t_p=10$ ms); single pulse; $V_R=0$ V;
			13960 18625	$T_j=T_{jmax}$ $T_j=25^\circ C$	180° half-sine wave; 60 Hz ($t_p=8.3$ ms); single pulse; $V_R=0$ V;
BLOCKING					
V_{RRM}	Repetitive peak reverse voltages	V	2000÷2800	$T_{jmin} < T_j < T_{jmax}$; 180° half-sine wave; 50 Hz;	
V_{RSM}	Non-repetitive peak reverse voltages	V	2100÷2900	$T_{jmin} < T_j < T_{jmax}$; 180° half-sine wave; 50 Hz; single pulse;	
V_R	Reverse continuous voltages	V	$0.75 \cdot V_{RRM}$	$T_j=T_{jmax}$;	
THERMAL					
T_{stg}	Storage temperature	$^\circ C$	-60÷50		
T_j	Operating junction temperature	$^\circ C$	-60÷175		
MECHANICAL					
F	Mounting force	kN	40÷50		
a	Acceleration	m/s^2	50	Device unclamped	
			100	Device clamped	

CHARACTERISTICS

Symbols and parameters		Units	Values	Conditions
ON-STATE				
V_{FM}	Peak forward voltage, max	V	1.80	$T_j=25\text{ }^\circ\text{C}; I_{FM}=12560\text{ A}$
$V_{F(TO)}$	Forward threshold voltage, max	V	0.85	$T_j=T_{j\text{ max}};$
r_T	Forward slope resistance, max	m Ω	0.065	$0.5\pi I_{FAV} < I_T < 1.5\pi I_{FAV}$
BLOCKING				
I_{RRM}	Repetitive peak reverse current, max	mA	100	$T_j=T_{j\text{ max}};$ $V_R=V_{RRM}$
SWITCHING				
Q_{rr}	Total recovered charge, max	μC	5200	$T_j=T_{j\text{ max}}; I_{TM}=2000\text{ A};$
t_{rr}	Reverse recovery time, max	μs	40	$di_R/dt=-10\text{ A}/\mu\text{s};$
I_{rrM}	Peak reverse recovery current, max	A	260	$V_R=100\text{ V}$
THERMAL				
R_{thjc}	Thermal resistance, junction to case, max	$^\circ\text{C}/\text{W}$	0.0085	Double side cooled
R_{thjc-A}			0.0187	Direct current
R_{thjc-K}			0.0153	Cathode side cooled
R_{thck}	Thermal resistance, case to heatsink, max	$^\circ\text{C}/\text{W}$	0.0020	Direct current
MECHANICAL				
w	Weight, typ	g	1500	
D_s	Surface creepage distance	mm (inch)	41.40 (1.630)	
D_a	Air strike distance	mm (inch)	23.10 (0.909)	

PART NUMBERING GUIDE

D	173	4000	28	N
1	2	3	4	5

1. D — Rectifier Diode
2. Design version
3. Average forward current, A
4. Voltage code
5. Ambient conditions: N – normal; T – tropical

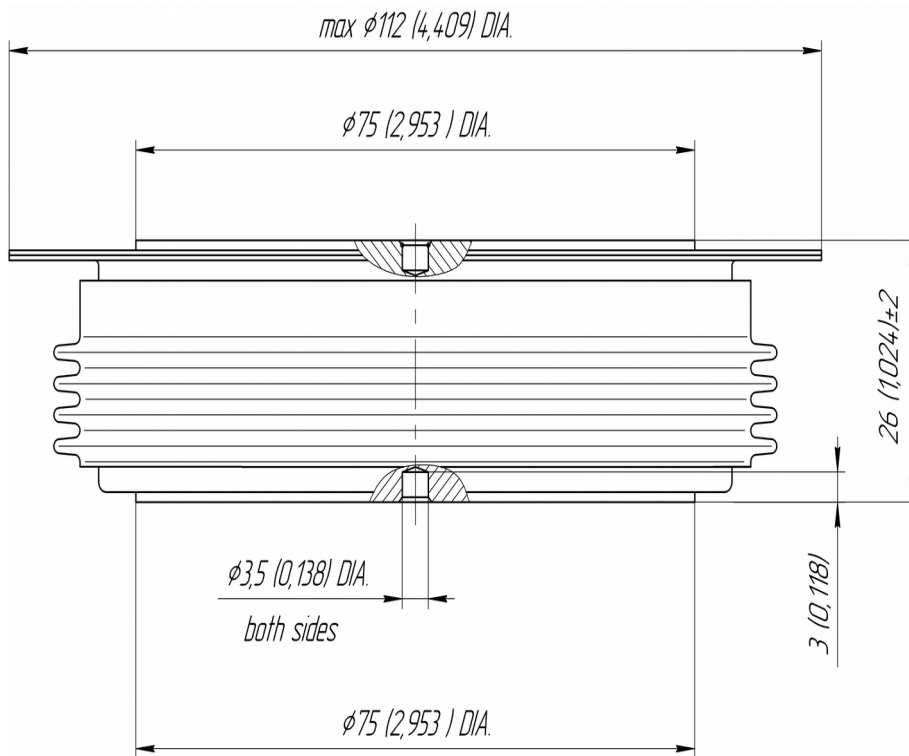

All dimensions in millimeters (inches)

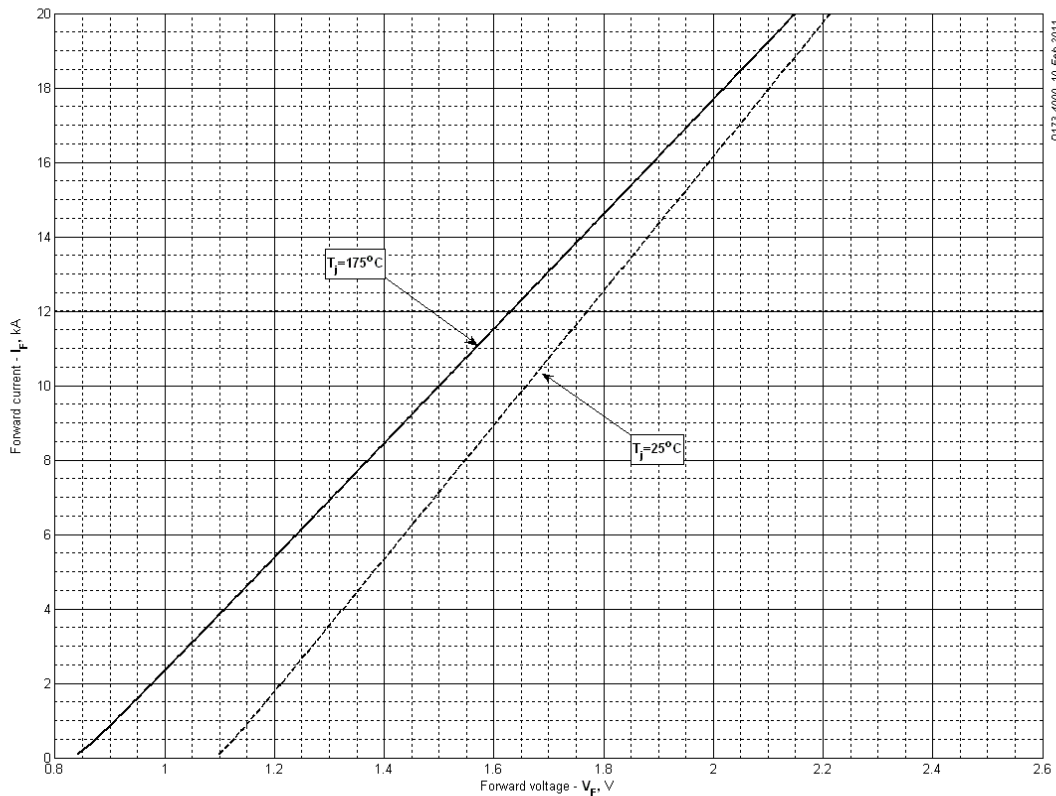

Fig 1 – Forward characteristics of Limit device

Analytical function for Forward characteristic:

$$V_F = A + B \cdot i_F + C \cdot \ln(i_F + 1) + D \cdot \sqrt{i_F}$$

	Coefficients for max curves	
	$T_j = 25^\circ\text{C}$	$T_j = T_{j\text{max}}$
A	1.092248	0.833413
B	0.054164	0.062967
C	-0.005206	-0.007827
D	0.011830	0.017784

Forward characteristic model (see Fig. 1).

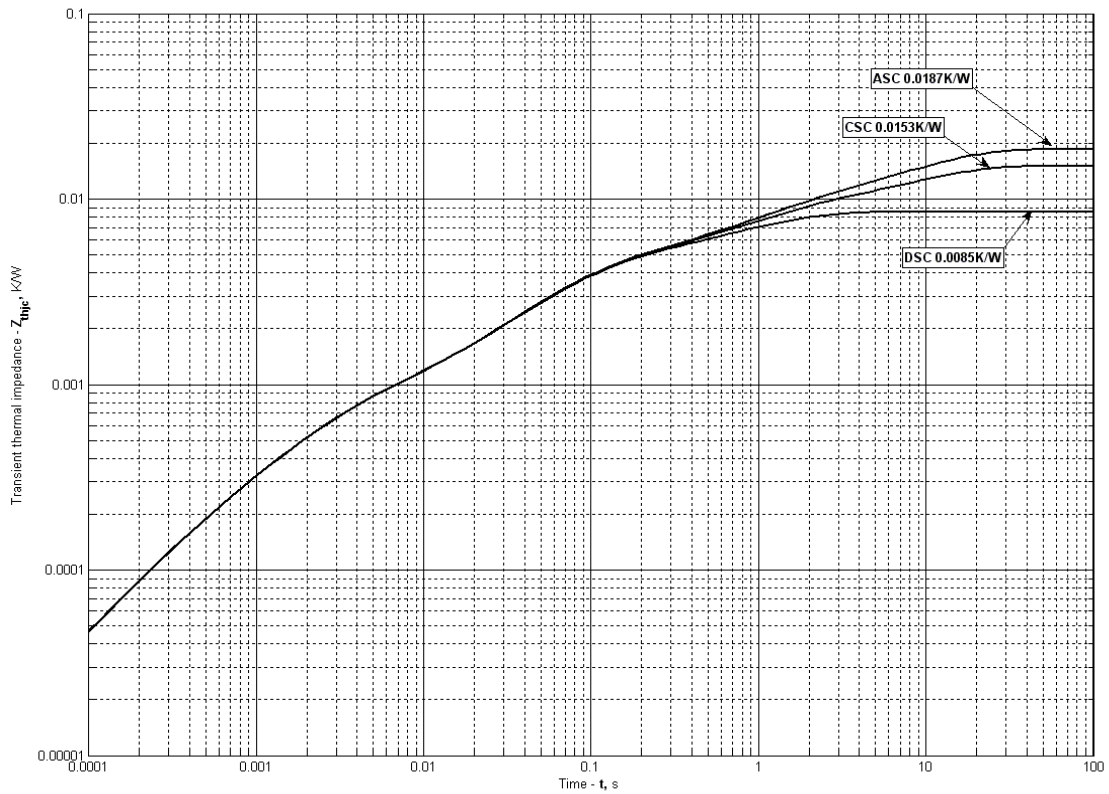

Fig 2 – Transient thermal impedance

Analytical function for Transient thermal impedance junction to case Z_{thjc} for DC:

$$Z_{thjc} = \sum_{i=1}^n R_i \left(1 - e^{-\frac{t}{\tau_i}} \right)$$

Where $i = 1$ to n , n is the number of terms in the series.

t = Duration of heating pulse in seconds.

Z_{thjc} = Thermal resistance at time t .

R_i = Amplitude of p_{th} term.

τ_i = Time constant of r_{th} term.

DC Double side cooled

i	1	2	3	4	5	6
R_i , K/W	0.00007989	0.002973	0.0005936	0.000846	0.00005975	0.003948
τ_i , S	1.688	0.06219	0.002329	0.138	0.0003243	0.9533

DC Cathode side cooled

i	1	2	3	4	5	6
R_i , K/W	0.006619	0.004034	0.0008595	0.002956	0.0005965	0.00005689
τ_i , S	9.744	1.025	0.1394	0.06237	0.002318	0.0003037

DC Anode side cooled

i	1	2	3	4	5	6
R_i , K/W	0.01013	0.004062	0.0009401	0.002853	0.0005963	0.00005641
τ_i , S	9.747	1.058	0.1304	0.06179	0.002313	0.0003013

Transient thermal impedance junction to case Z_{thjc} model (see Fig. 2)

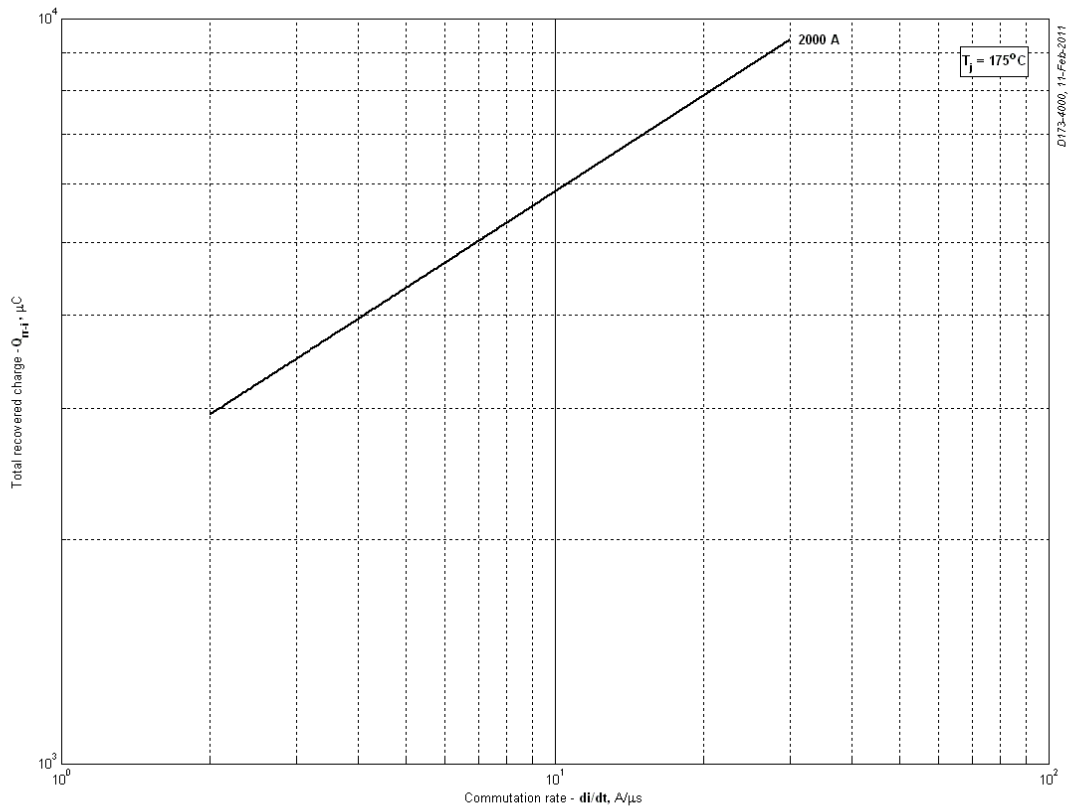

Fig 3 - Total recovered charge(integral), Q_{rr-i}

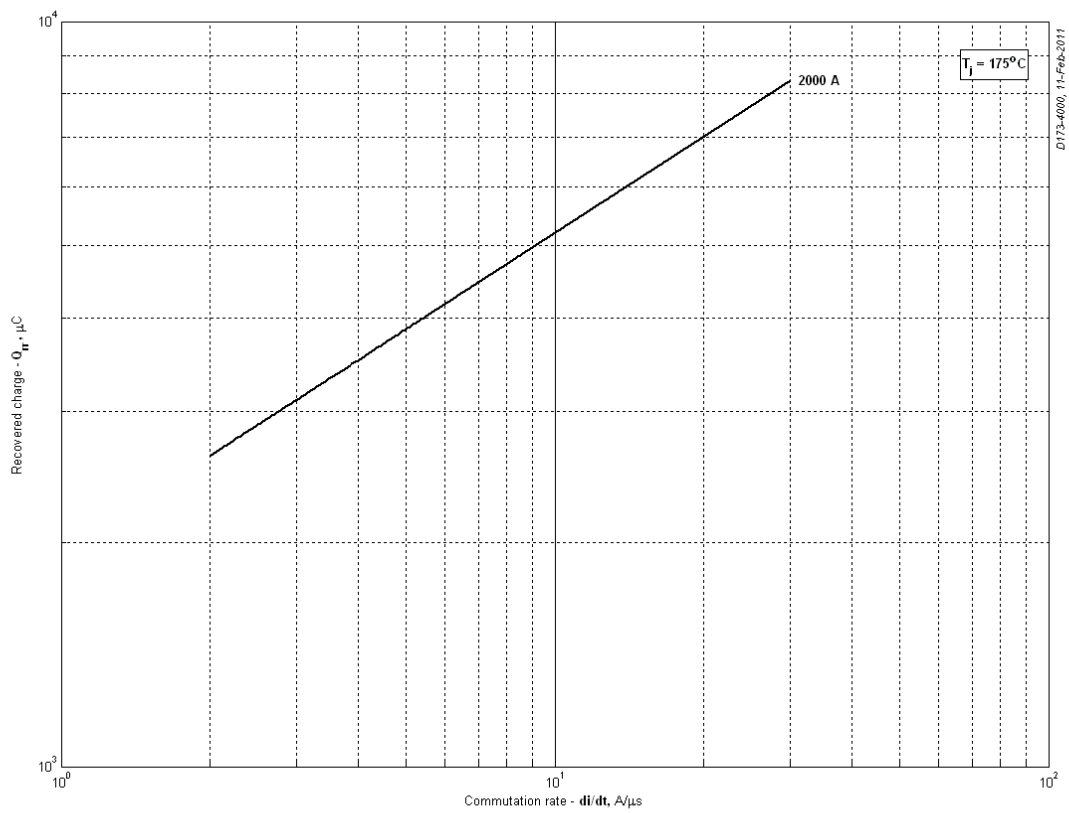

Fig 4 - Total recovered charge(50% chord), Q_{rr}

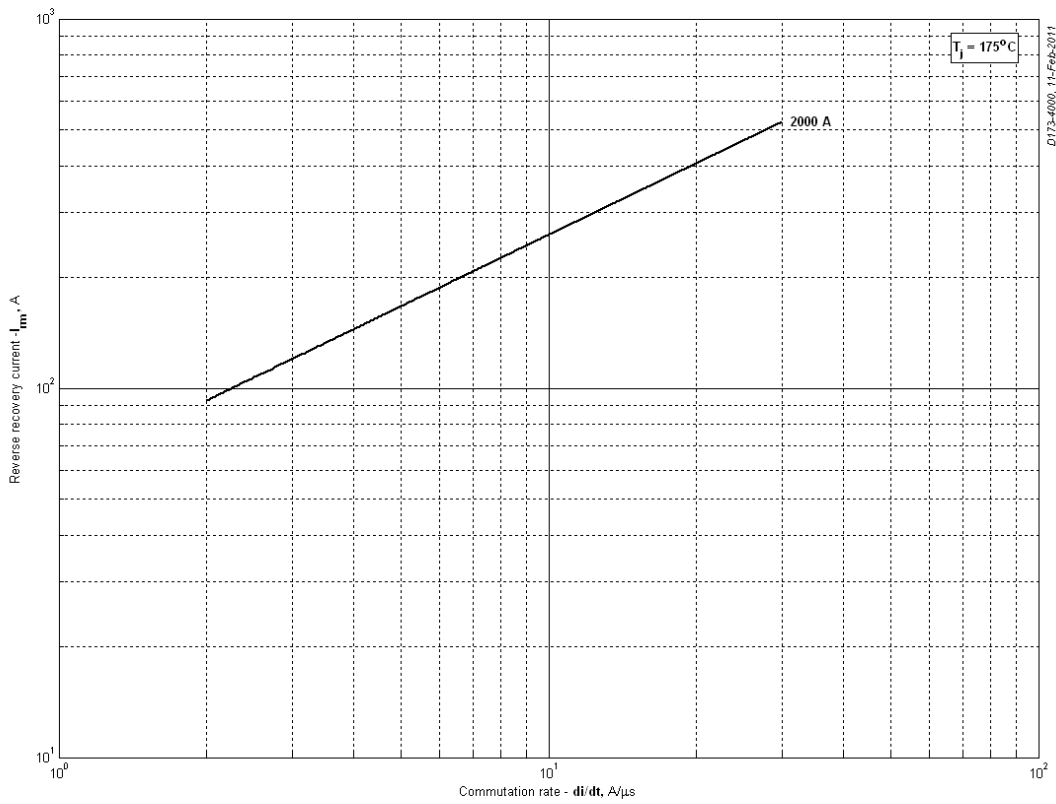

Fig 5 - Peak reverse recovery current, I_{rm}

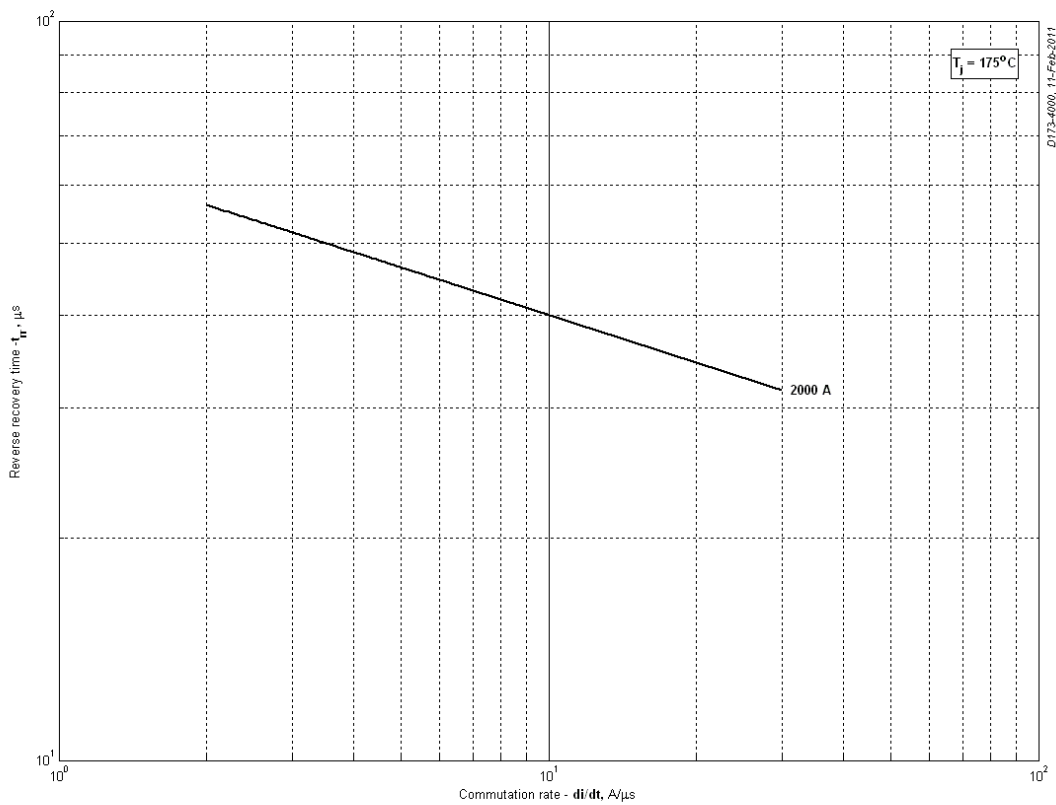

Fig 6 - Recovery time, t_{rr} (50% chord)

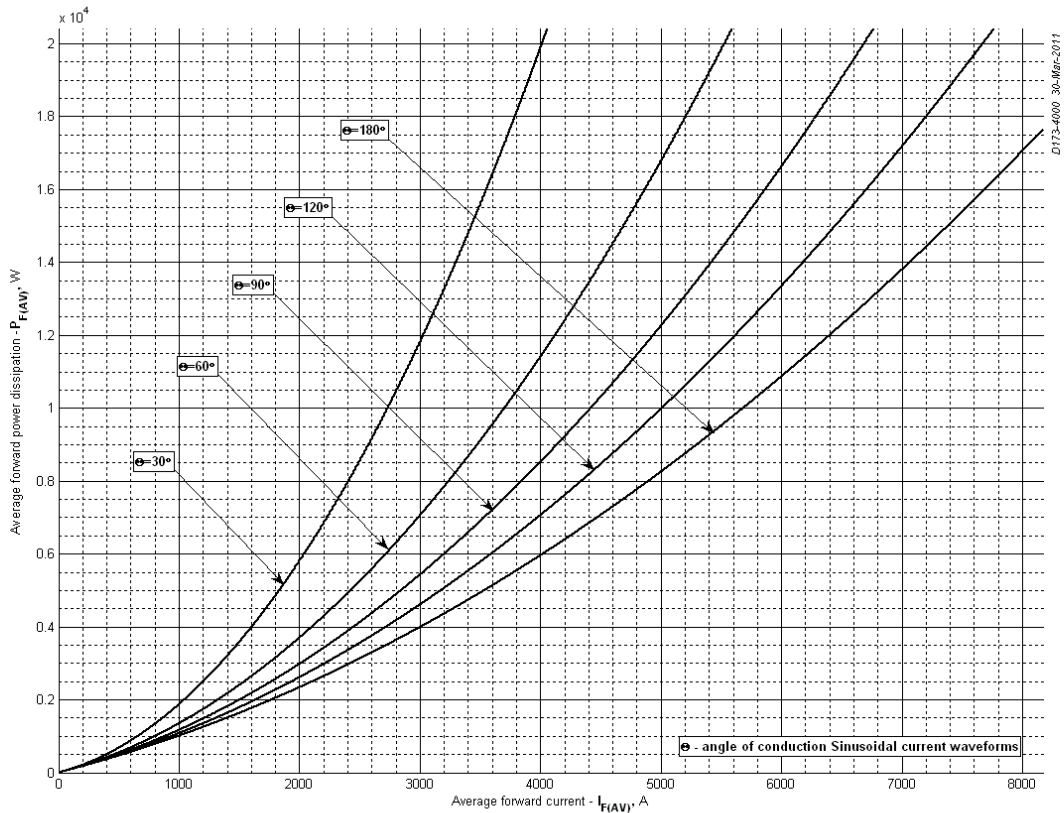

Fig 7 - Mean forward power dissipation P_{FAV} vs. Mean forward current I_{FAV} for sinusoidal current waveforms at different conduction angles ($f=50\text{Hz}$, DSC)

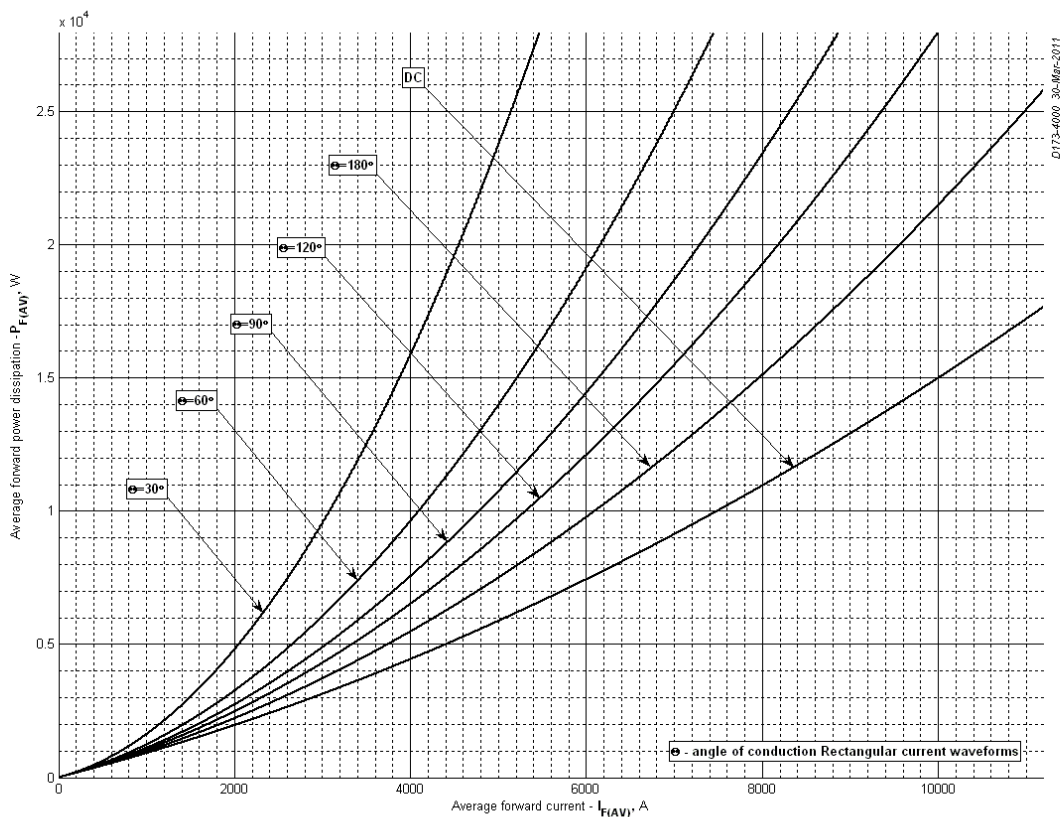

Fig 8 – Mean forward power dissipation P_{FAV} vs. Mean forward current I_{FAV} for rectangular current waveforms at different conduction angles and for DC ($f=50\text{Hz}$, DSC)

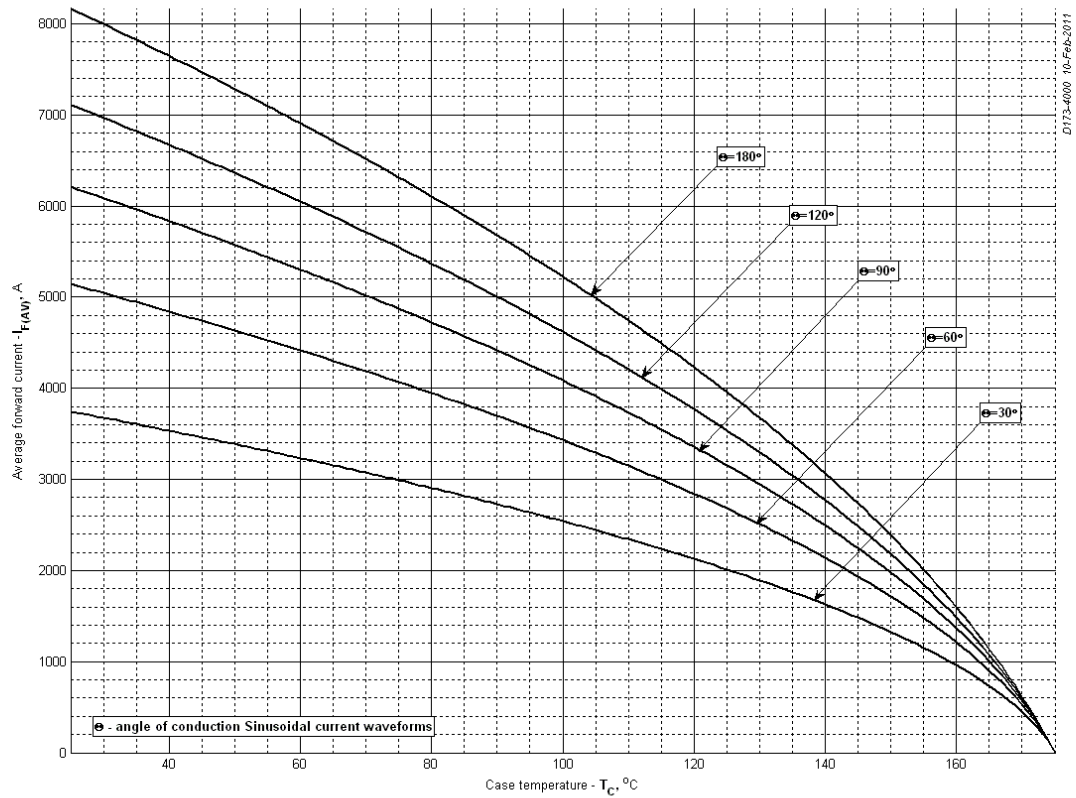

Fig 9 – Mean forward current I_{FAV} vs. Case temperature T_C for sinusoidal current waveforms at different conduction angles ($f=50\text{Hz}$, DSC)

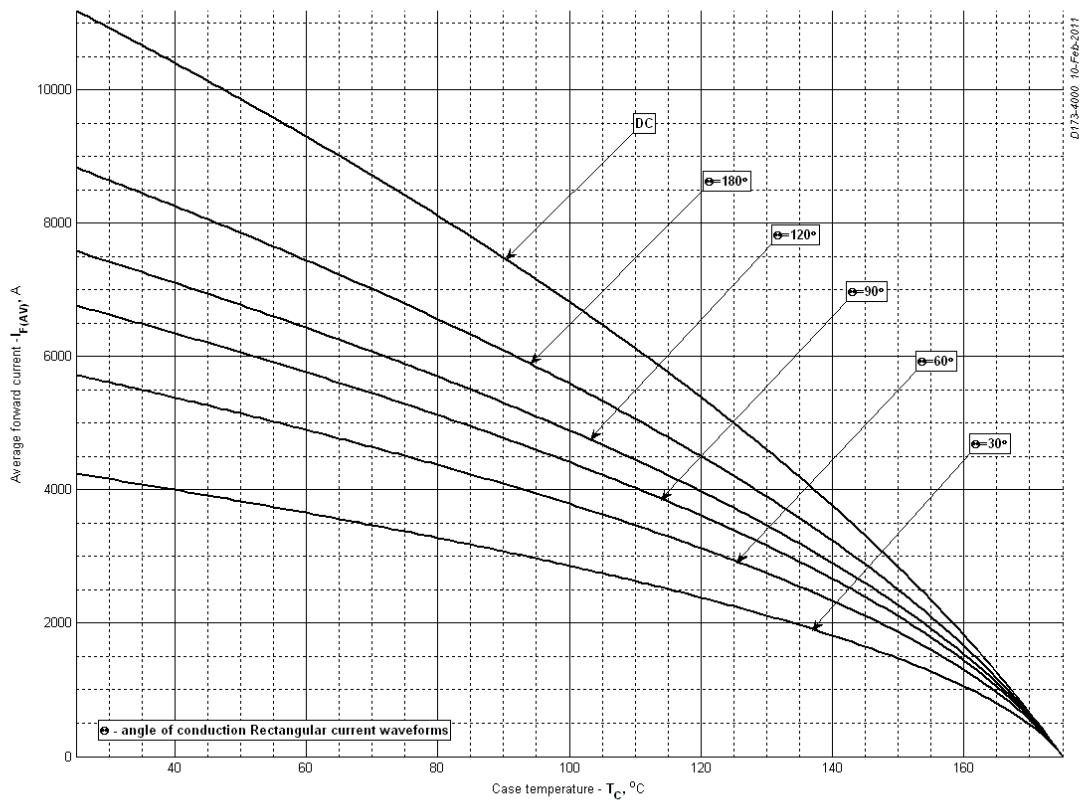

Fig 10 - Mean forward current I_{FAV} vs. Case temperature T_C for rectangular current waveforms at different conduction angles and for DC ($f=50\text{Hz}$, DSC)

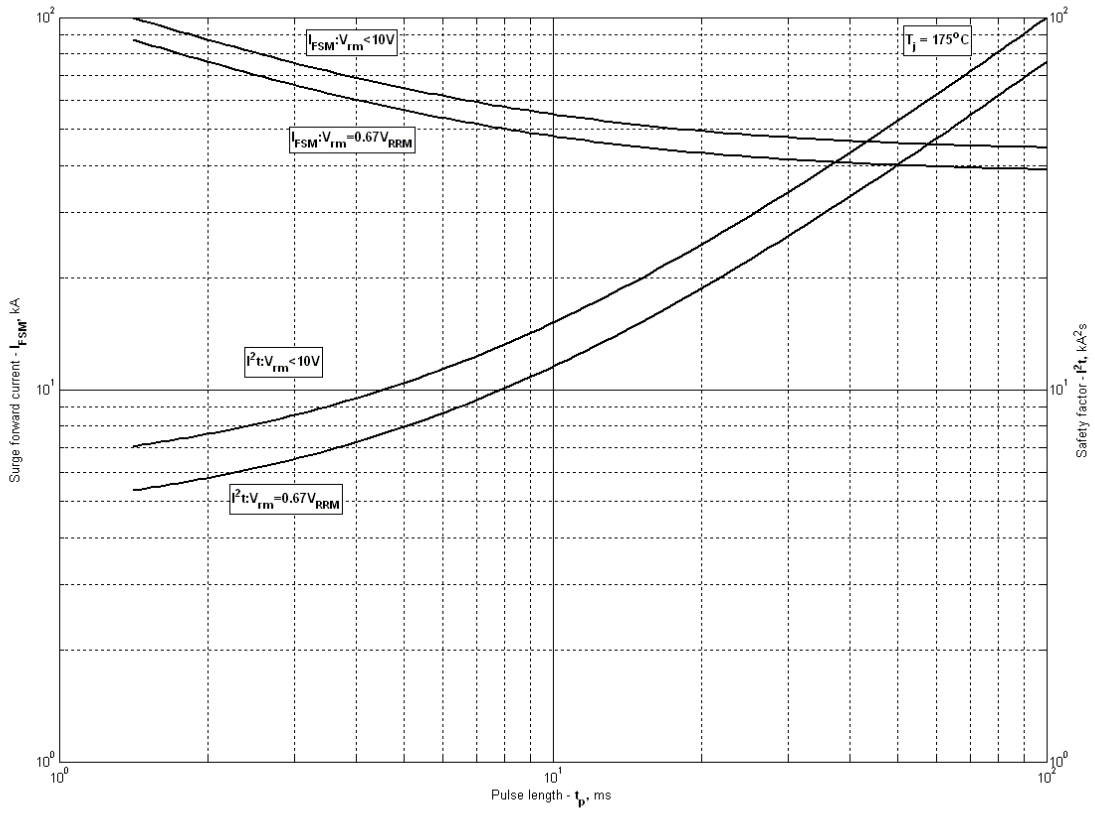

Fig 11 – Maximum surge and I^2t ratings

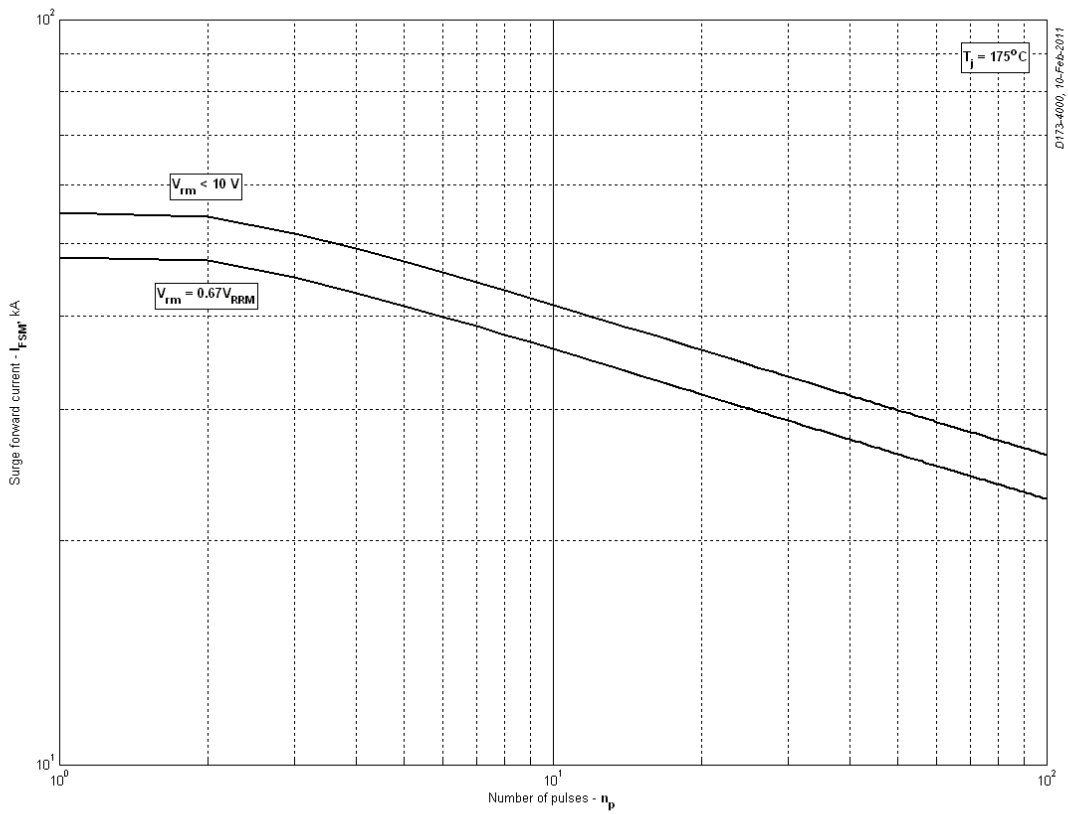

Fig 12 - Maximum surge ratings