

High power cycling capability
 Low on-state and switching losses
 Optimized for line frequency rectifiers
 Designed for traction and industrial applications

Rectifier Diode Type D173-5000-20

Average forward current	I_{FAV}	5000 A
Repetitive peak reverse voltage	V_{RRM}	2000 V
V_{RRM} , V	2000	
Voltage code	20	
T_j , °C	-60 ÷ 175	

MAXIMUM ALLOWABLE RATINGS

Symbols and parameters		Units	Values	Test conditions
ON-STATE				
I_{FAV}	Average forward current	A	5000 5450	$T_c=109\text{ °C}$; Double side cooled; $T_c=100\text{ °C}$; Double side cooled; 180° half-sine wave; 50 Hz
I_{FRMS}	RMS forward current	A	7850	$T_c=109\text{ °C}$; Double side cooled; 180° half-sine wave; 50 Hz
I_{FSM}	Surge forward current	kA	60.0 69.0	$T_j=T_{j\max}$ $T_j=25\text{ °C}$ 180° half-sine wave; 50 Hz ($t_p=10\text{ ms}$); single pulse; $V_R=0\text{ V}$;
			63.0 72.0	$T_j=T_{j\max}$ $T_j=25\text{ °C}$ 180° half-sine wave; 60 Hz ($t_p=8.3\text{ ms}$); single pulse; $V_R=0\text{ V}$;
I^2t	Safety factor	$A^2s \cdot 10^3$	18000 23805	$T_j=T_{j\max}$ $T_j=25\text{ °C}$ 180° half-sine wave; 50 Hz ($t_p=10\text{ ms}$); single pulse; $V_R=0\text{ V}$;
			16470 21510	$T_j=T_{j\max}$ $T_j=25\text{ °C}$ 180° half-sine wave; 60 Hz ($t_p=8.3\text{ ms}$); single pulse; $V_R=0\text{ V}$;
BLOCKING				
V_{RRM}	Repetitive peak reverse voltages	V	2000	$T_{j\min} < T_j < T_{j\max}$; 180° half-sine wave; 50 Hz;
V_{RSM}	Non-repetitive peak reverse voltages	V	2100	$T_{j\min} < T_j < T_{j\max}$; 180° half-sine wave; 50 Hz; single pulse;
V_R	Reverse continuous voltages	V	$0.75 \cdot V_{RRM}$	$T_j=T_{j\max}$;
THERMAL				
T_{stg}	Storage temperature	°C	-60÷50	
T_j	Operating junction temperature	°C	-60÷175	
MECHANICAL				
F	Mounting force	kN	40÷50	
a	Acceleration	m/s^2	50	Device unclamped
			100	Device clamped

CHARACTERISTICS

Symbols and parameters		Units	Values	Conditions	
ON-STATE					
V_{FM}	Peak forward voltage, max	V	1.65	$T_j=25\text{ }^\circ\text{C}; I_{FM}=12560\text{ A}$	
$V_{F(TO)}$	Forward threshold voltage, max	V	0.75	$T_j=T_{j\text{ max}};$	
r_T	Forward slope resistance, max	m Ω	0.065	$0.5\pi I_{FAV} < I_T < 1.5\pi I_{FAV}$	
BLOCKING					
I_{RRM}	Repetitive peak reverse current, max	mA	150	$T_j=T_{j\text{ max}};$ $V_R=V_{RRM}$	
SWITCHING					
Q_{rr}	Total recovered charge, max	μC	4370	$T_j=T_{j\text{ max}}; I_{FM}=2000\text{ A};$	
t_{rr}	Reverse recovery time, max	μs	35	$di_R/dt=-10\text{ A}/\mu\text{s};$	
I_{rrM}	Peak reverse recovery current, max	A	250	$V_R=100\text{ V}$	
THERMAL					
R_{thjc}	Thermal resistance, junction to case, max	$^\circ\text{C}/\text{W}$	0.0085	Direct current	Double side cooled
R_{thjc-A}			0.0187		Anode side cooled
R_{thjc-K}			0.0153		Cathode side cooled
R_{thck}	Thermal resistance, case to heatsink, max	$^\circ\text{C}/\text{W}$	0.0020	Direct current	
MECHANICAL					
w	Weight, typ	g	1500		
D_s	Surface creepage distance	mm (inch)	41.40 (1.630)		
D_a	Air strike distance	mm (inch)	23.10 (0.909)		

PART NUMBERING GUIDE

D	173	5000	20	N
1	2	3	4	5

1. D — Rectifier Diode
2. Design version
3. Average forward current, A
4. Voltage code
5. Ambient conditions: N – normal; T – tropical

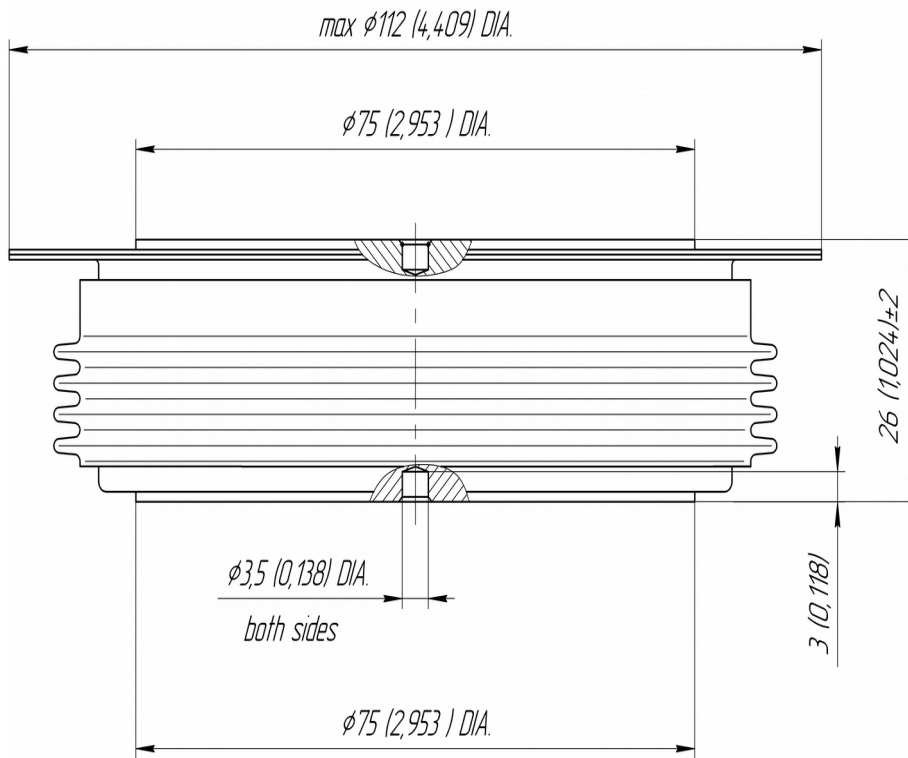

All dimensions in millimeters (inches)

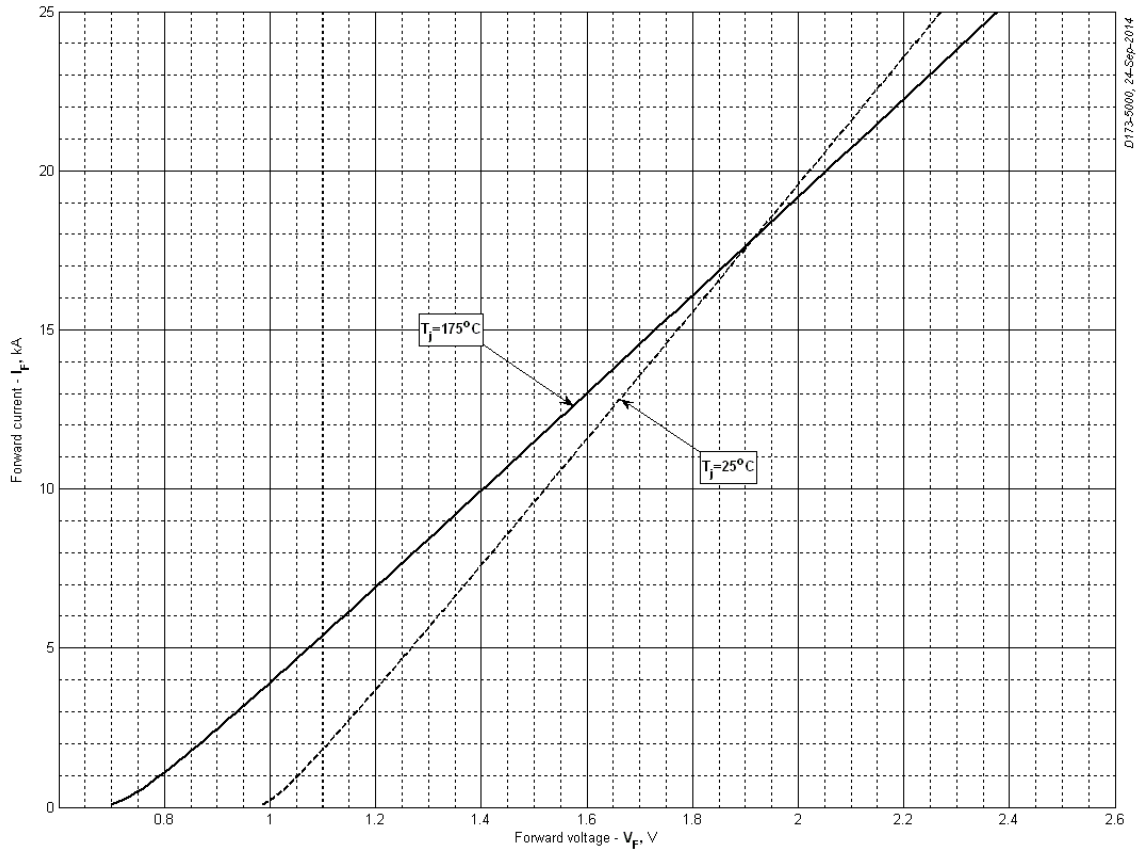

Fig 1 – Forward characteristics of Limit device

Analytical function for Forward characteristic:

$$V_F = A + B \cdot i_F + C \cdot \ln(i_F + 1) + D \cdot \sqrt{i_F}$$

	Coefficients for max curves	
	$T_j = 25^\circ\text{C}$	$T_j = T_{j \max}$
A	0.991905	0.710549
B	0.049060	0.063519
C	0.019009	0.028578
D	-0.002115	-0.003179

Forward characteristic model (see Fig. 1).

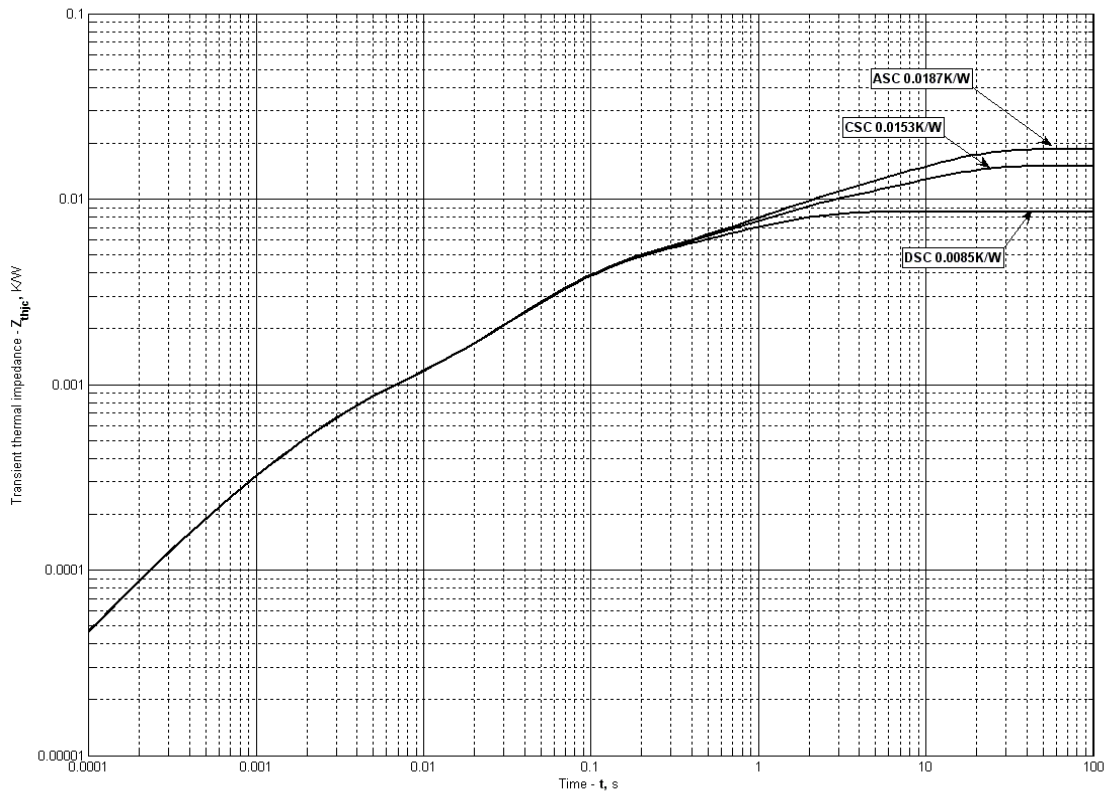

Fig 2 – Transient thermal impedance

Analytical function for Transient thermal impedance junction to case Z_{thjc} for DC:

$$Z_{thjc} = \sum_{i=1}^n R_i \left(1 - e^{-\frac{t}{\tau_i}} \right)$$

Where $i = 1$ to n , n is the number of terms in the series.

t = Duration of heating pulse in seconds.

Z_{thjc} = Thermal resistance at time t .

R_i = Amplitude of p_{th} term.

τ_i = Time constant of r_{th} term.

DC Double side cooled

i	1	2	3	4	5	6
R_i, K/W	0.00007989	0.002973	0.0005936	0.000846	0.00005975	0.003948
τ_i, S	1.688	0.06219	0.002329	0.138	0.0003243	0.9533

DC Cathode side cooled

i	1	2	3	4	5	6
R_i, K/W	0.006619	0.004034	0.0008595	0.002956	0.0005965	0.00005689
τ_i, S	9.744	1.025	0.1394	0.06237	0.002318	0.0003037

DC Anode side cooled

i	1	2	3	4	5	6
R_i, K/W	0.01013	0.004062	0.0009401	0.002853	0.0005963	0.00005641
τ_i, S	9.747	1.058	0.1304	0.06179	0.002313	0.0003013

Transient thermal impedance junction to case Z_{thjc} model (see Fig. 2)

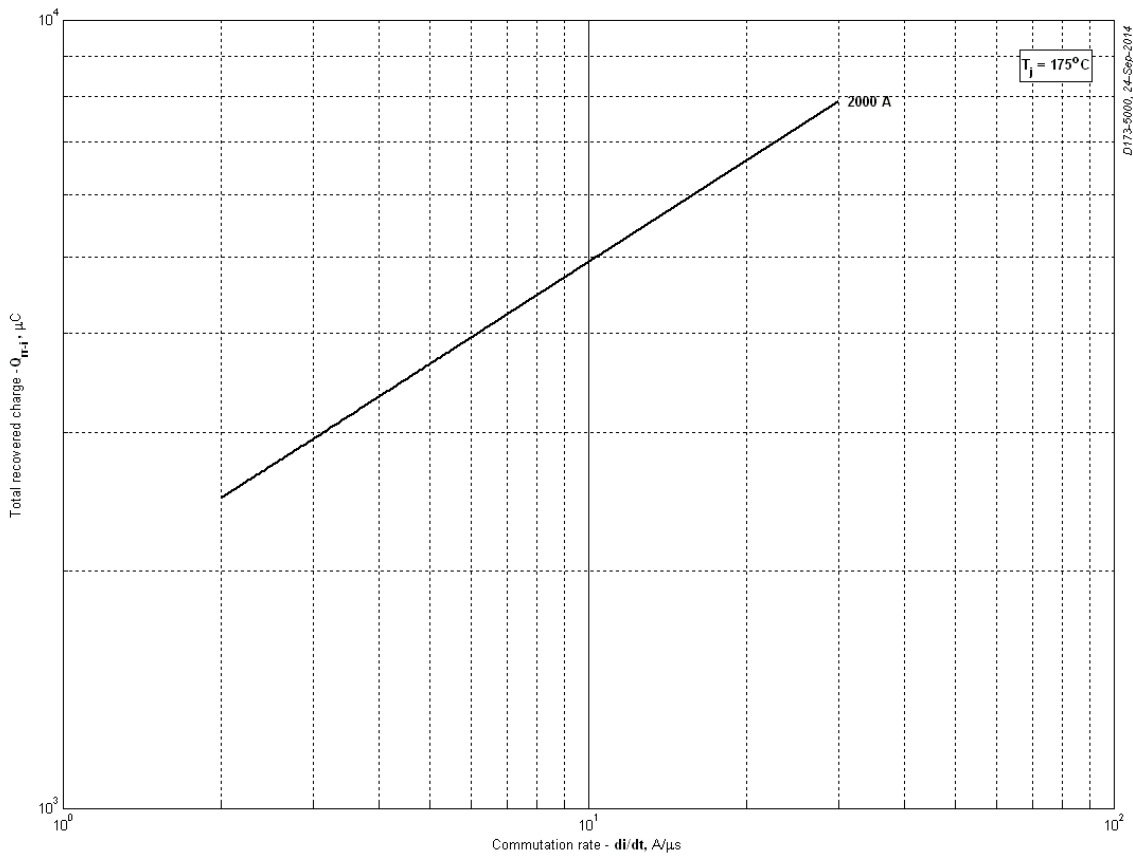

Fig 3 - Total recovered charge(integral), Q_{rr-i}

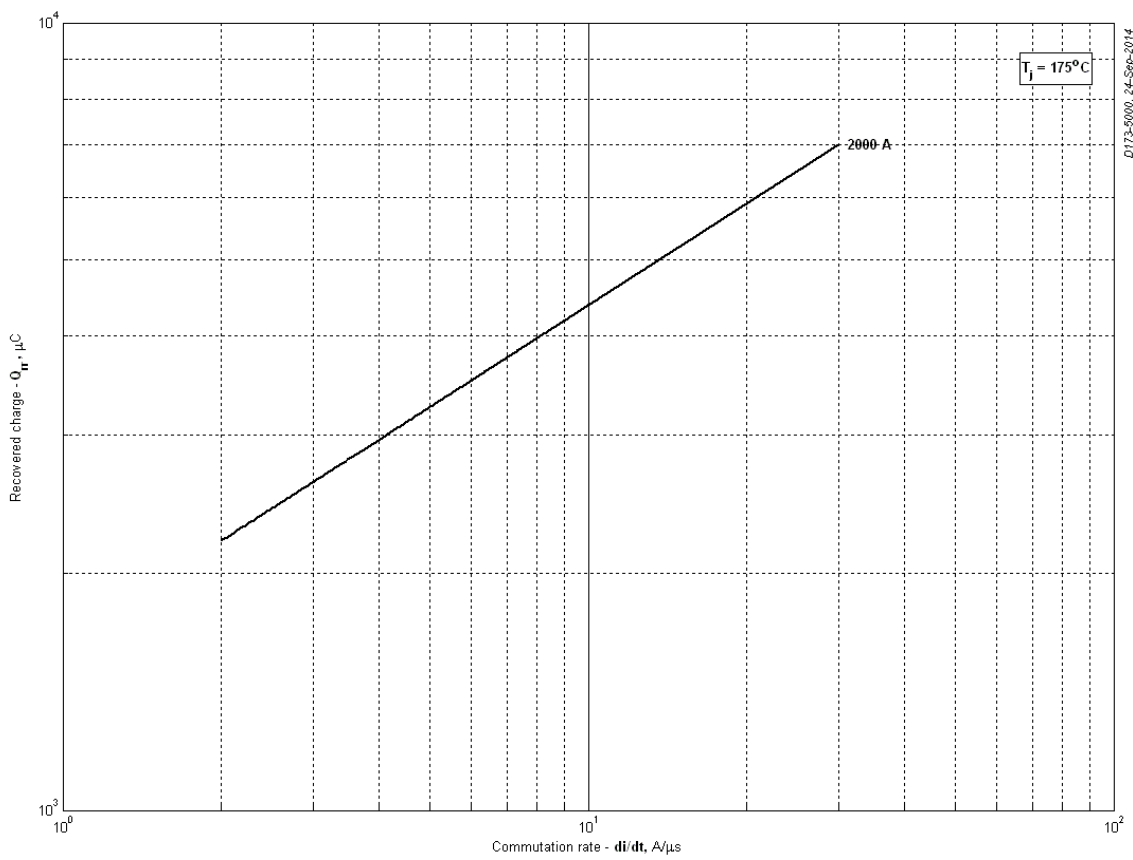

Fig 4 - Total recovered charge(50% chord), Q_{rr}

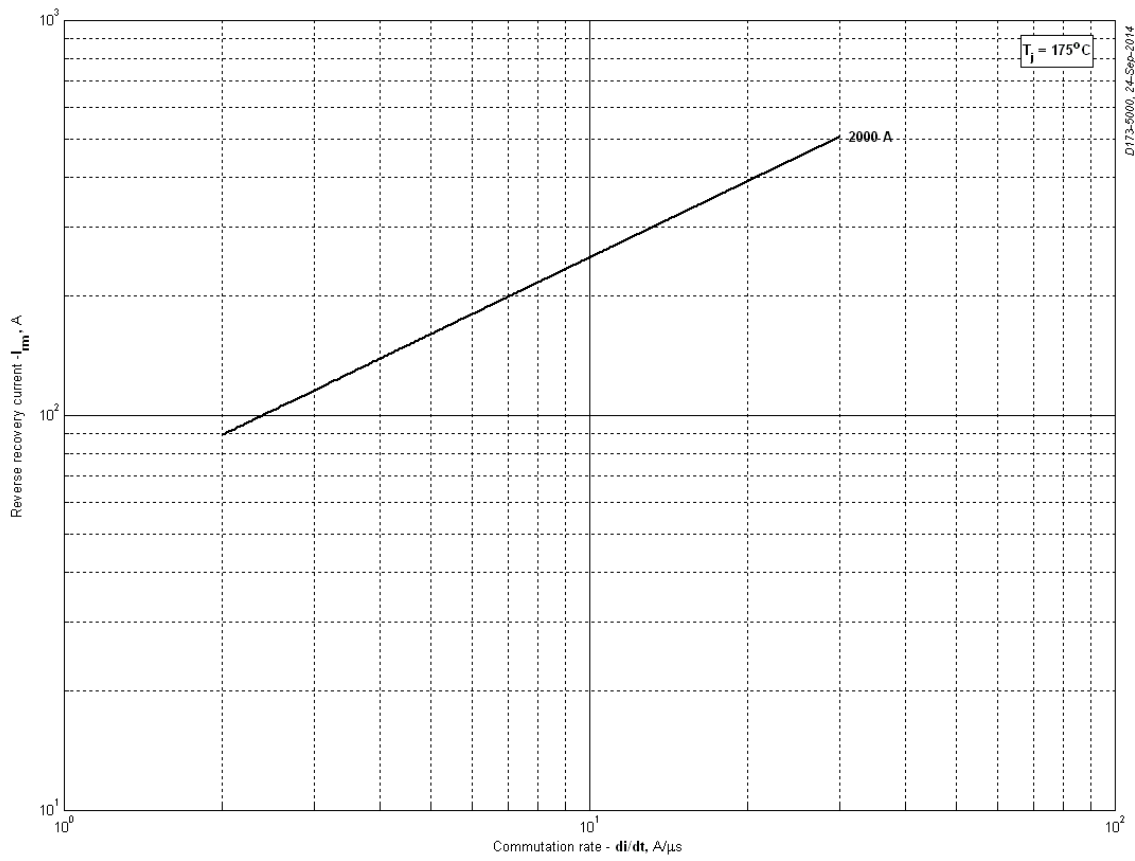

Fig 5 - Peak reverse recovery current, I_{rm}

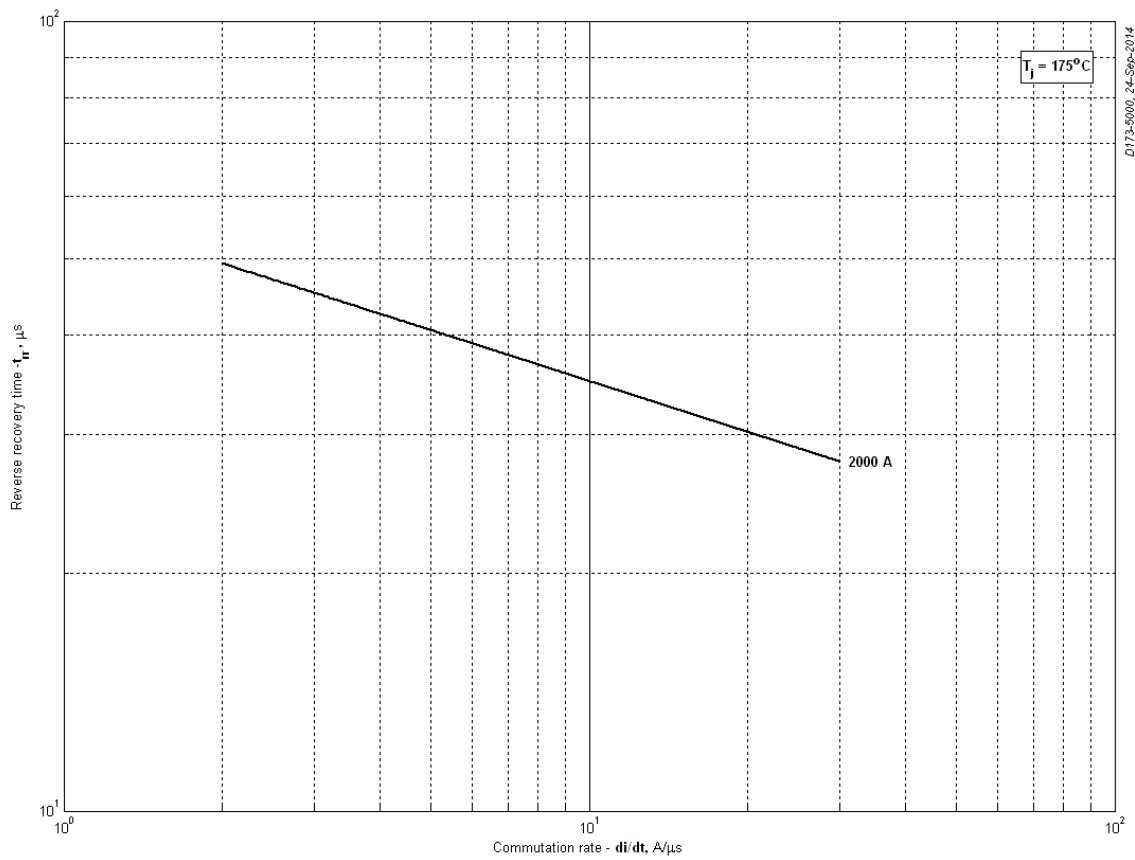

Fig 6 - Recovery time, t_{rr} (50% chord)

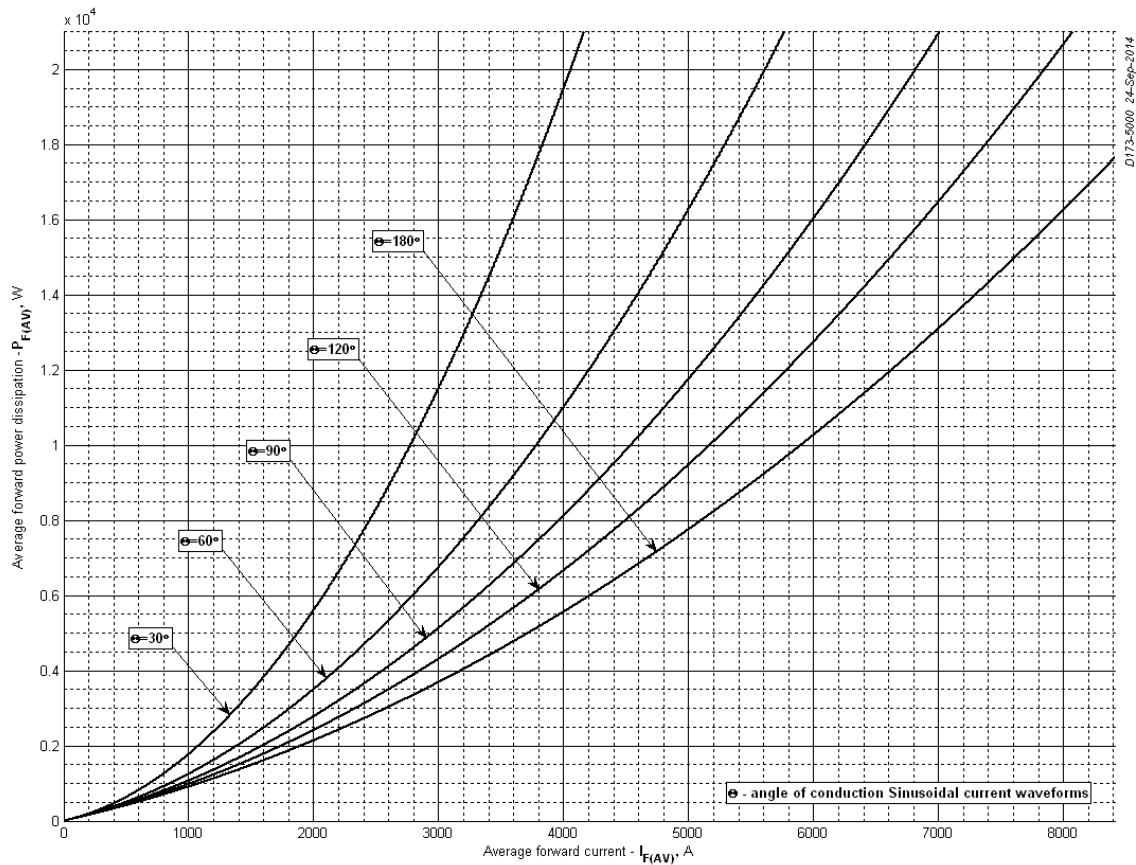

Fig 7 - Mean forward power dissipation P_{FAV} vs. Mean forward current I_{FAV} for sinusoidal current waveforms at different conduction angles ($f=50\text{Hz}$, DSC)

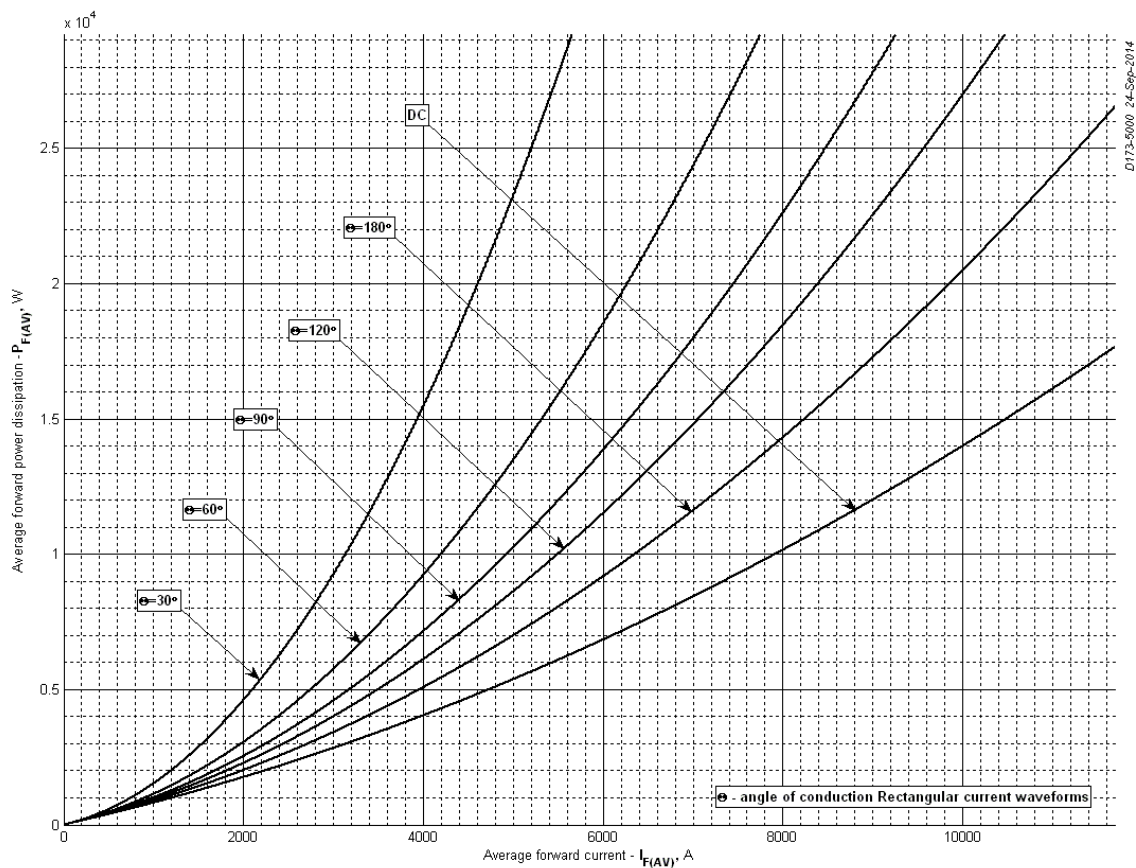

Fig 8 – Mean forward power dissipation P_{FAV} vs. Mean forward current I_{FAV} for rectangular current waveforms at different conduction angles and for DC ($f=50\text{Hz}$, DSC)

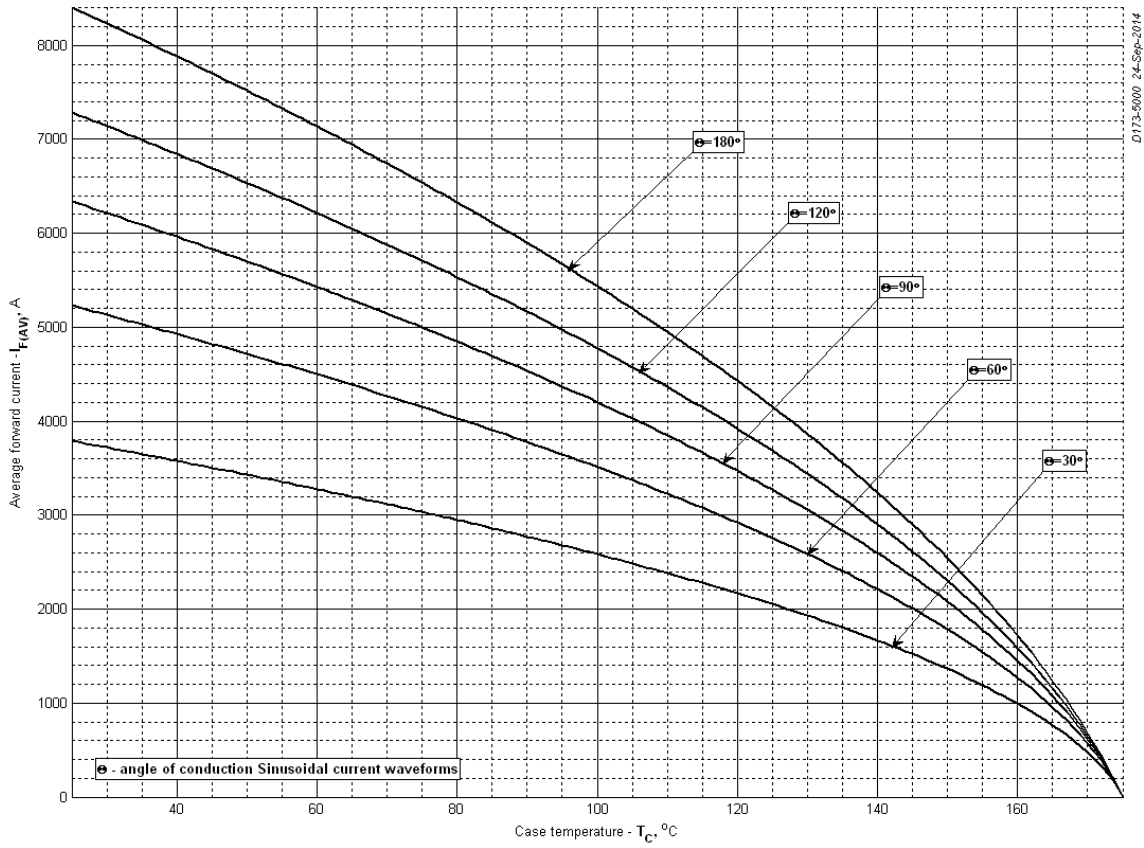

Fig 9 – Mean forward current I_{FAV} vs. Case temperature T_C for sinusoidal current waveforms at different conduction angles ($f=50\text{Hz}$, DSC)

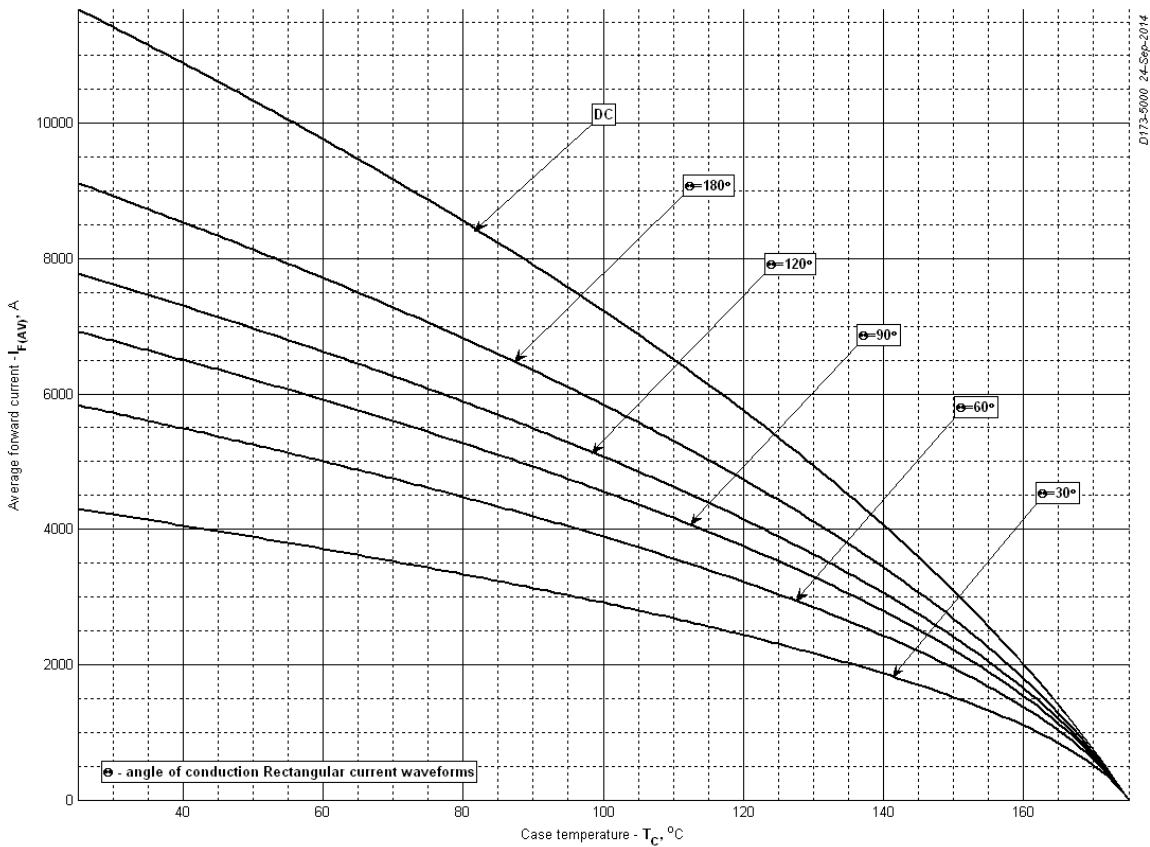

Fig 10 - Mean forward current I_{FAV} vs. Case temperature T_C for rectangular current waveforms at different conduction angles and for DC ($f=50\text{Hz}$, DSC)

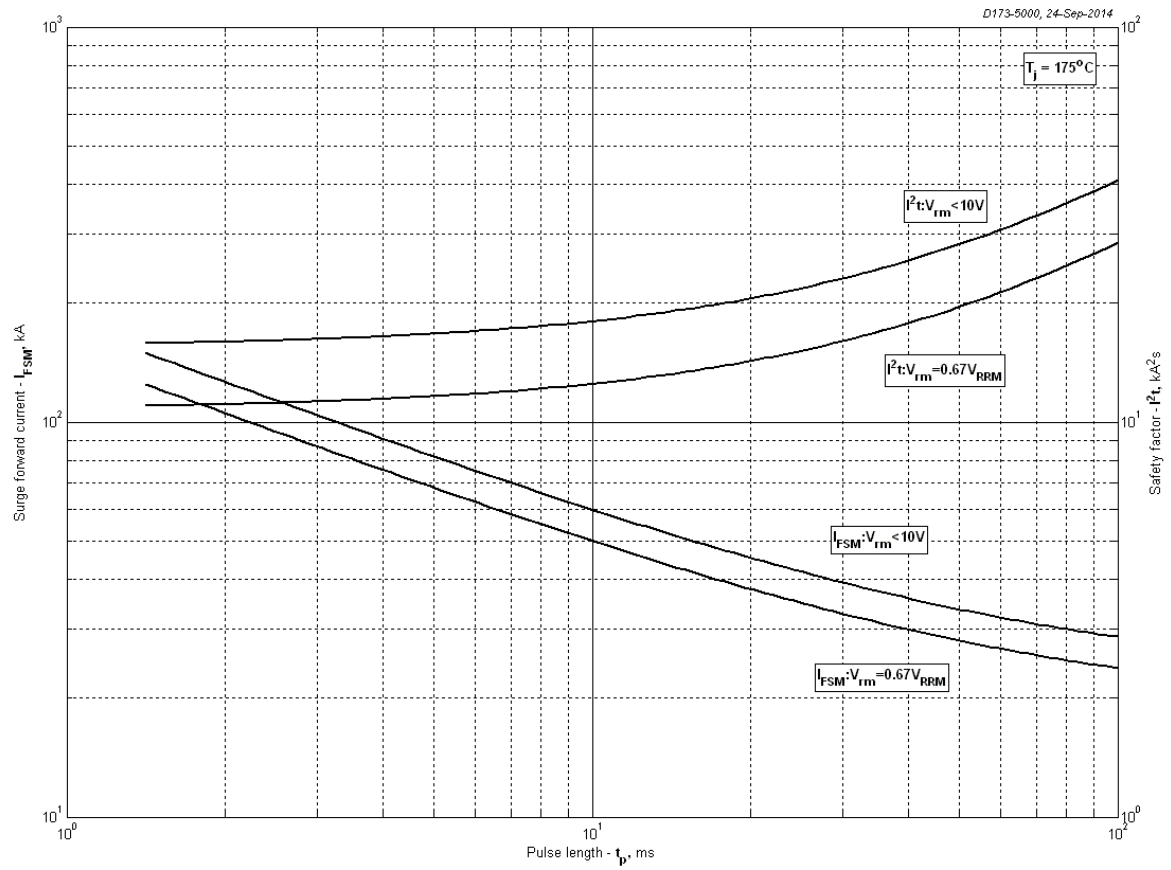

Fig 11 – Maximum surge and I^2t ratings

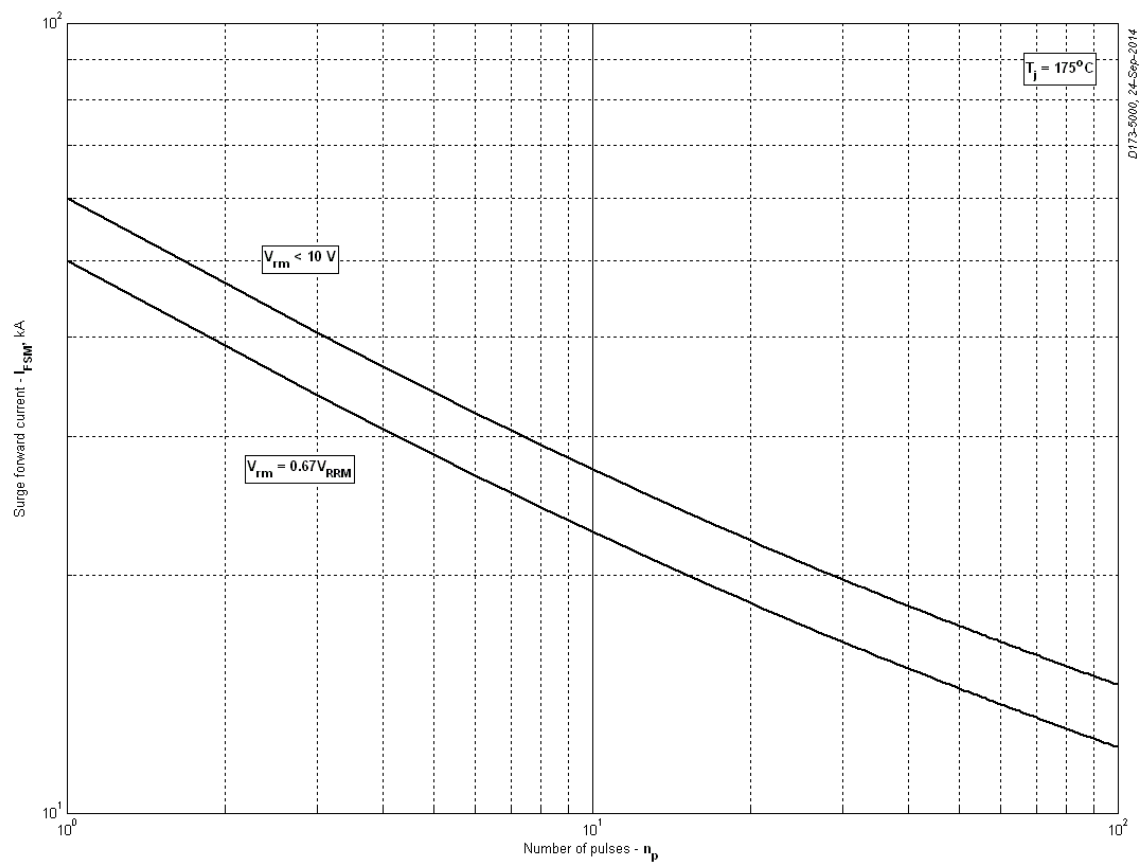

Fig 12 - Maximum surge ratings