

High power cycling capability
 Low on-state and switching losses
 Optimized for line frequency rectifiers
 Designed for traction and industrial applications

Rectifier Diode Type D453-1250-65

Average forward current					I_{FAV}		1250 A					
Repetitive peak reverse voltage					V_{RRM}		4600 ÷ 6500 V					
V_{RRM}, V	4600	4800	5000	5200	5400	5600	5800	6000	6200	6400	6500	
Voltage code	46	48	50	52	54	56	58	60	62	64	65	
$T_j, ^\circ C$	-60 ÷ 150											

MAXIMUM ALLOWABLE RATINGS

Symbols and parameters		Units	Values	Test conditions	
ON-STATE					
I_{FAV}	Average forward current	A	1250 1495	$T_c=101\ ^\circ C$; Double side cooled; $T_c=85\ ^\circ C$; Double side cooled; 180° half-sine wave; 50 Hz	
I_{FRMS}	RMS forward current	A	1963	$T_c=101\ ^\circ C$; Double side cooled; 180° half-sine wave; 50 Hz	
I_{FSM}	Surge forward current	kA	18.0 21.0	$T_j=T_{j\ max}$ $T_j=25\ ^\circ C$	180° half-sine wave; 50 Hz ($t_p=10\ ms$); single pulse; $V_R=0\ V$;
			19.0 22.0	$T_j=T_{j\ max}$ $T_j=25\ ^\circ C$	180° half-sine wave; 60 Hz ($t_p=8.3\ ms$); single pulse; $V_R=0\ V$;
I^2t	Safety factor	$A^2s \cdot 10^3$	1620 2205	$T_j=T_{j\ max}$ $T_j=25\ ^\circ C$	180° half-sine wave; 50 Hz ($t_p=10\ ms$); single pulse; $V_R=0\ V$;
			1495 2005	$T_j=T_{j\ max}$ $T_j=25\ ^\circ C$	180° half-sine wave; 60 Hz ($t_p=8.3\ ms$); single pulse; $V_R=0\ V$;
BLOCKING					
V_{RRM}	Repetitive peak reverse voltages	V	4600 ÷ 6500	$T_{j\ min} < T_j < T_{j\ max}$; 180° half-sine wave; 50 Hz;	
V_{RSM}	Non-repetitive peak reverse voltages	V	4700 ÷ 6600	$T_{j\ min} < T_j < T_{j\ max}$; 180° half-sine wave; 50 Hz; single pulse;	
V_R	Reverse continuous voltages	V	$0.75 \cdot V_{RRM}$	$T_j = T_{j\ max}$;	
THERMAL					
T_{stg}	Storage temperature	$^\circ C$	-60 ÷ 50		
T_j	Operating junction temperature	$^\circ C$	-60 ÷ 150		
MECHANICAL					
F	Mounting force	kN	24.0 ÷ 28.0		
a	Acceleration	m/s^2	50	Device unclamped	
			100	Device clamped	

CHARACTERISTICS

Symbols and parameters		Units	Values	Conditions	
ON-STATE					
V_{FM}	Peak forward voltage, max	V	2.40	$T_j=25\text{ }^\circ\text{C}; I_{FM}=3925\text{ A}$	
			2.60	$T_j=150\text{ }^\circ\text{C}; I_{FM}=4000\text{ A}$	
$V_{F(TO)}$	Forward threshold voltage, max	V	0.95	$T_j=T_{j\text{ max}}$;	
r_T	Forward slope resistance, max	m Ω	0.400	$0.5\pi I_{FAV} < I_T < 1.5\pi I_{FAV}$	
BLOCKING					
I_{RRM}	Repetitive peak reverse current, max	mA	100	$T_j=T_{j\text{ max}}$; $V_R=V_{RRM}$	
SWITCHING					
Q_{rr}	Total recovered charge, max	μC	6825	$T_j=T_{j\text{ max}}$; $I_{TM}=1250\text{ A}$;	
t_{rr}	Reverse recovery time, max	μs	65	$di_R/dt=-5\text{ A}/\mu\text{s}$;	
I_{rrM}	Peak reverse recovery current, max	A	210	$V_R=100\text{ V}$;	
THERMAL					
R_{thjc}	Thermal resistance, junction to case, max	$^\circ\text{C}/\text{W}$	0.0180	Direct current	Double side cooled
R_{thjc-A}			0.0396		Anode side cooled
R_{thjc-K}			0.0324		Cathode side cooled
R_{thck}	Thermal resistance, case to heatsink, max	$^\circ\text{C}/\text{W}$	0.0040	Direct current	
MECHANICAL					
w	Weight, typ	g	510		
D_s	Surface creepage distance	mm (inch)	38.84 (1.529)		
D_a	Air strike distance	mm (inch)	22.50 (0.886)		

PART NUMBERING GUIDE

D	453	1250	65	N
1	2	3	4	5

1. D — Rectifier Diode
2. Design version
3. Average forward current, A
4. Voltage code
5. Ambient conditions: N – normal; T – tropical

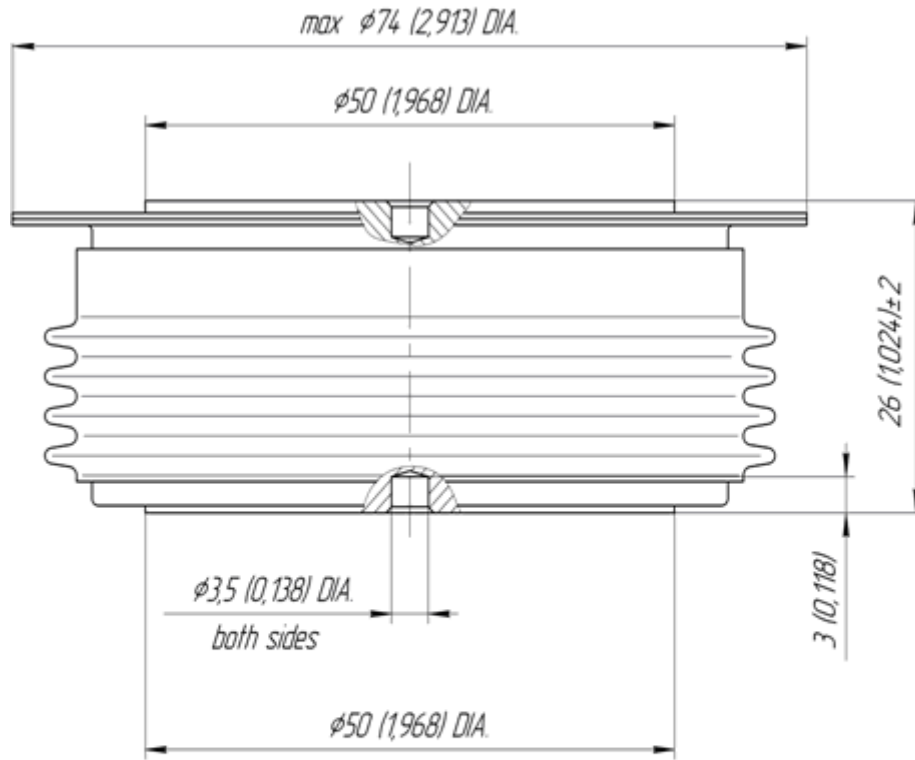

All dimensions in millimeters (inches)

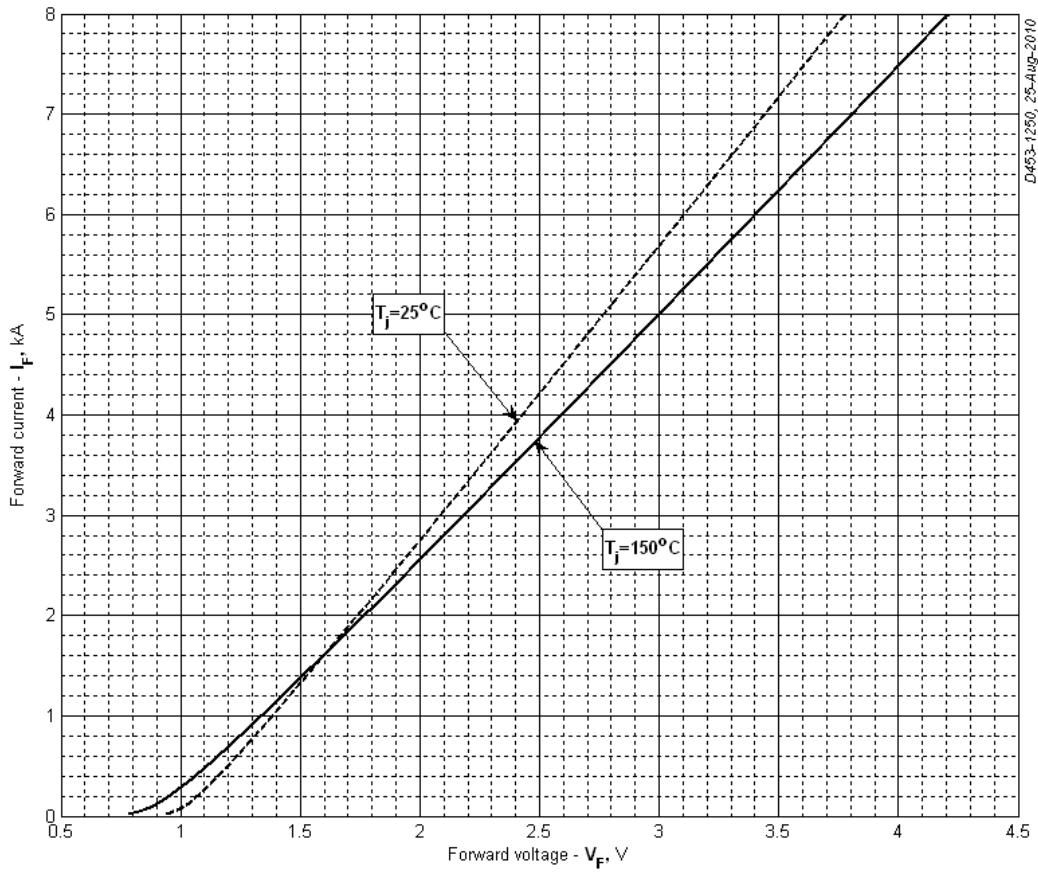

Fig 1 – Forward characteristics of Limit device

Analytical function for Forward characteristic:

$$V_F = A + B \cdot i_F + C \cdot \ln(i_F + 1) + D \cdot \sqrt{i_F}$$

	Coefficients for max curves	
	$T_j = 25^\circ\text{C}$	$T_j = T_{j,\text{max}}$
A	0.901161	0.727622
B	0.301193	0.351999
C	-0.206268	-0.292790
D	0.325872	0.462564

Forward characteristic model (see Fig. 1).

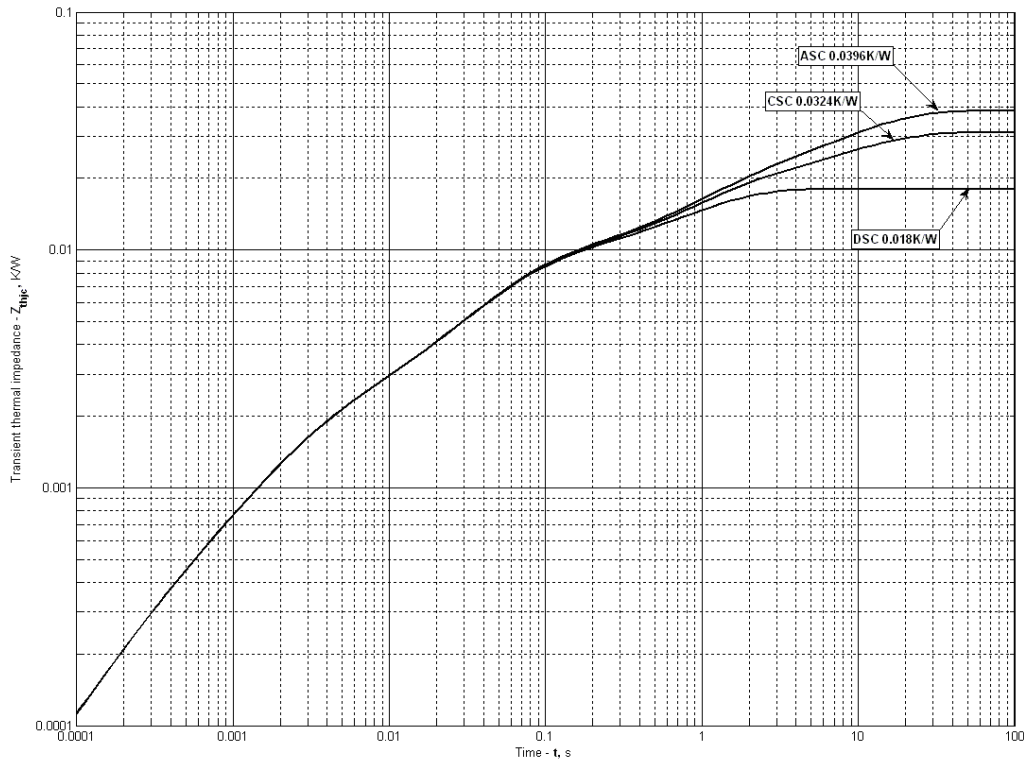

Fig 2 – Transient thermal impedance

Analytical function for Transient thermal impedance junction to case Z_{thjc} for DC:

$$Z_{thjc} = \sum_{i=1}^n R_i \left(1 - e^{-\frac{t}{\tau_i}} \right)$$

Where $i = 1$ to n , n is the number of terms in the series.

t = Duration of heating pulse in seconds.

Z_{thjc} = Thermal resistance at time t .

R_i = Amplitude of p_{th} term.

τ_i = Time constant of r_{th} term.

DC Double side cooled

i	1	2	3	4	5	6
R_i , K/W	0.009241	0.006037	0.001231	0.001054	0.0003396	0.00009575
τ_i , s	0.9673	0.04967	0.002733	0.07734	0.001638	0.0002248

DC Cathode side cooled

i	1	2	3	4	5	6
R_i , K/W	0.01318	0.009281	0.006055	0.001018	0.001535	0.0001182
τ_i , s	9.745	1.028	0.05591	0.03732	0.002468	0.0002687

DC Anode side cooled

i	1	2	3	4	5	6
R_i , K/W	0.02041	0.009325	0.006949	0.0001252	0.001516	0.0001119
τ_i , s	9.752	1.065	0.05344	0.01407	0.002421	0.0002554

Transient thermal impedance junction to case Z_{thjc} model (see Fig. 2)

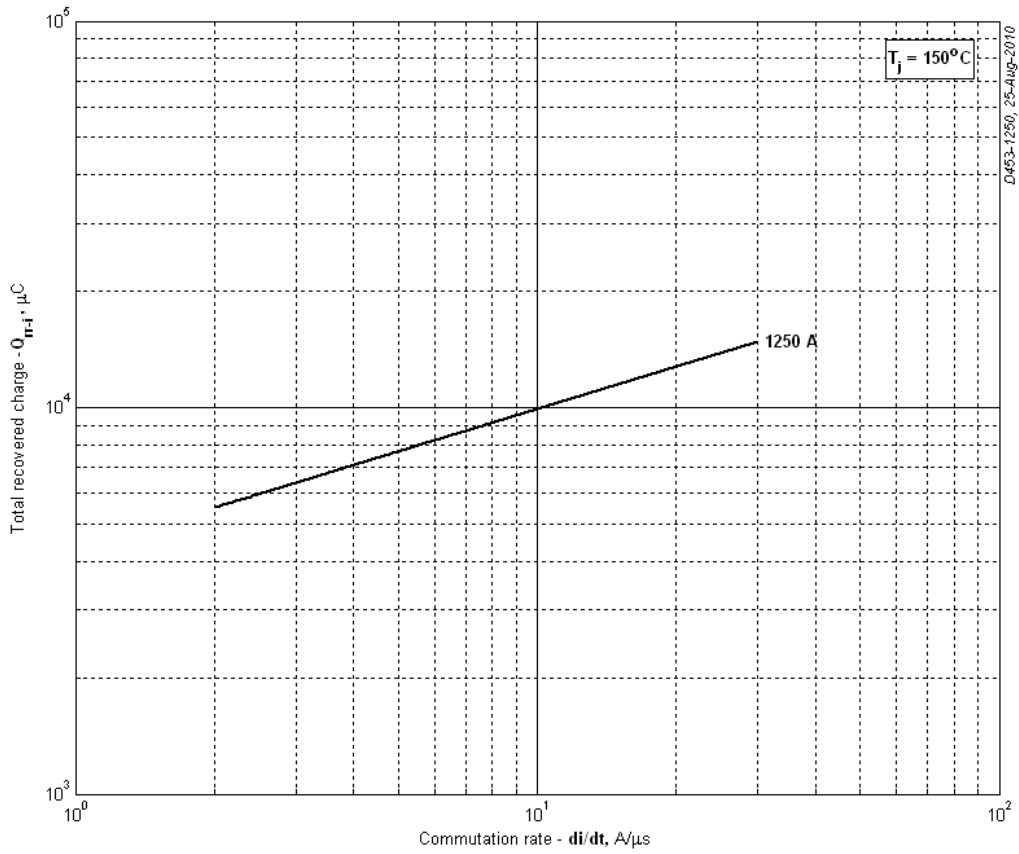

Fig 3 - Total recovered charge(integral), Q_{rr-i}

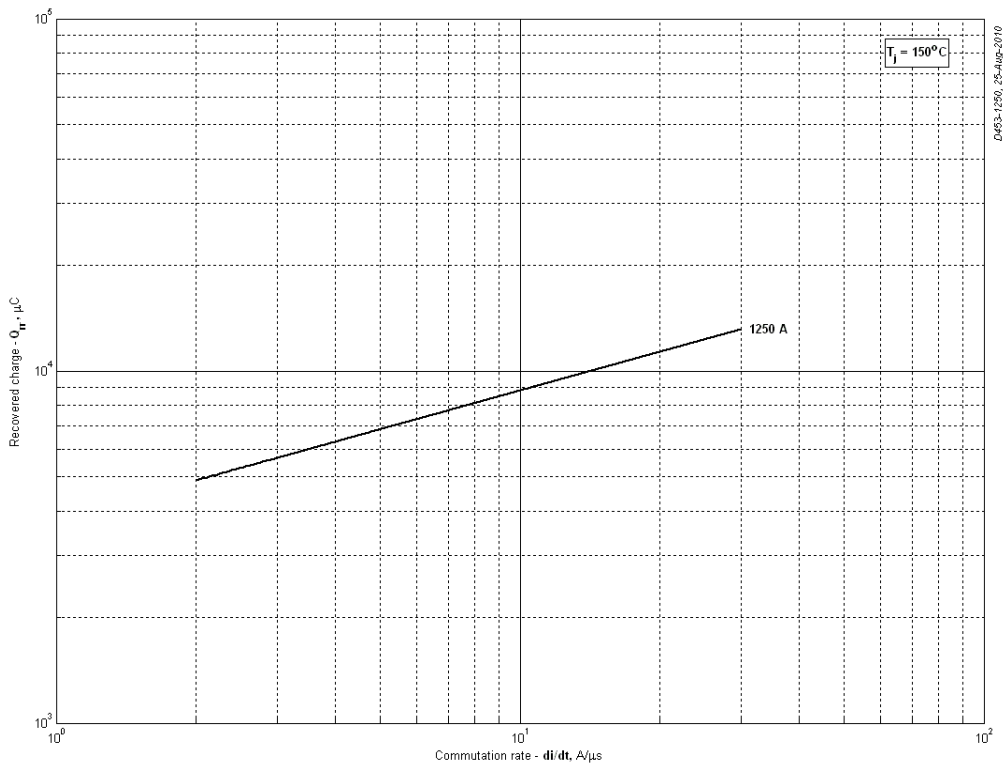

Fig 4 - Total recovered charge(50% chord), Q_{rr}

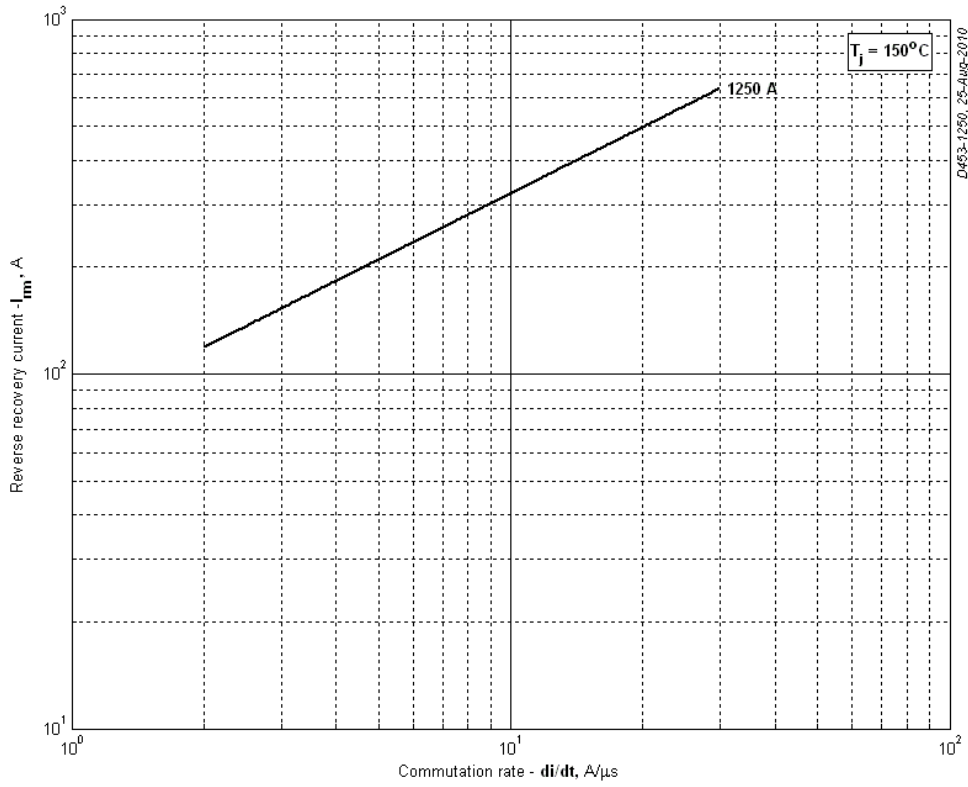

Fig 5 - Peak reverse recovery current, I_{rm}

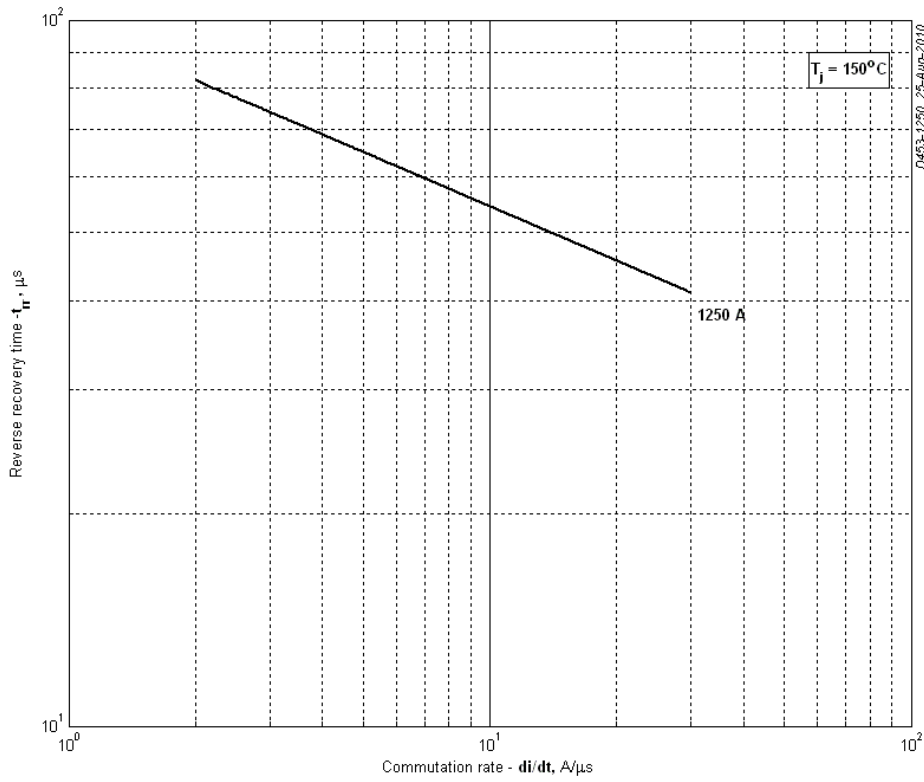
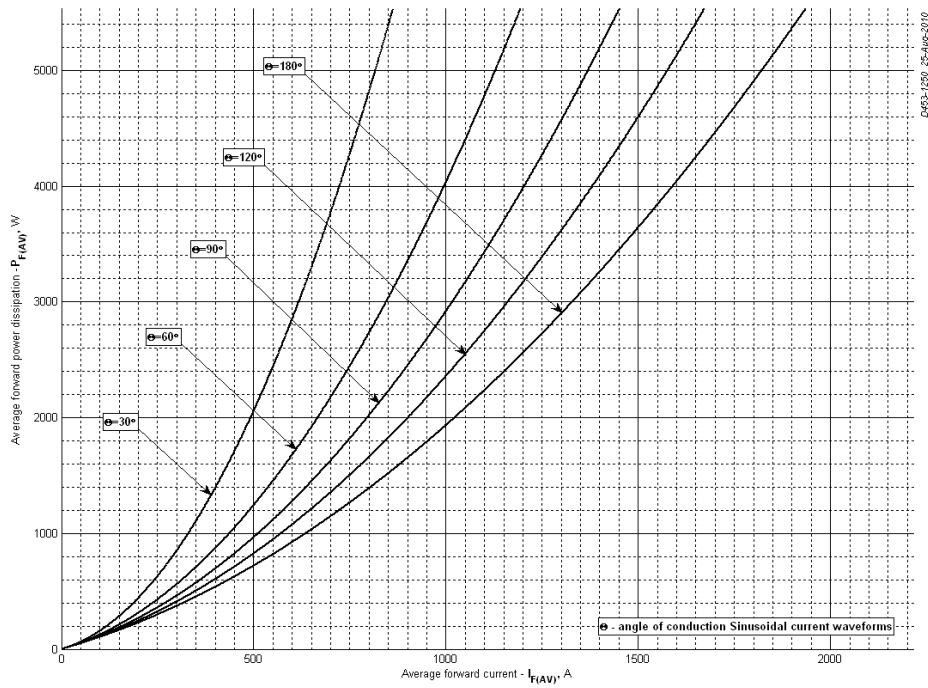
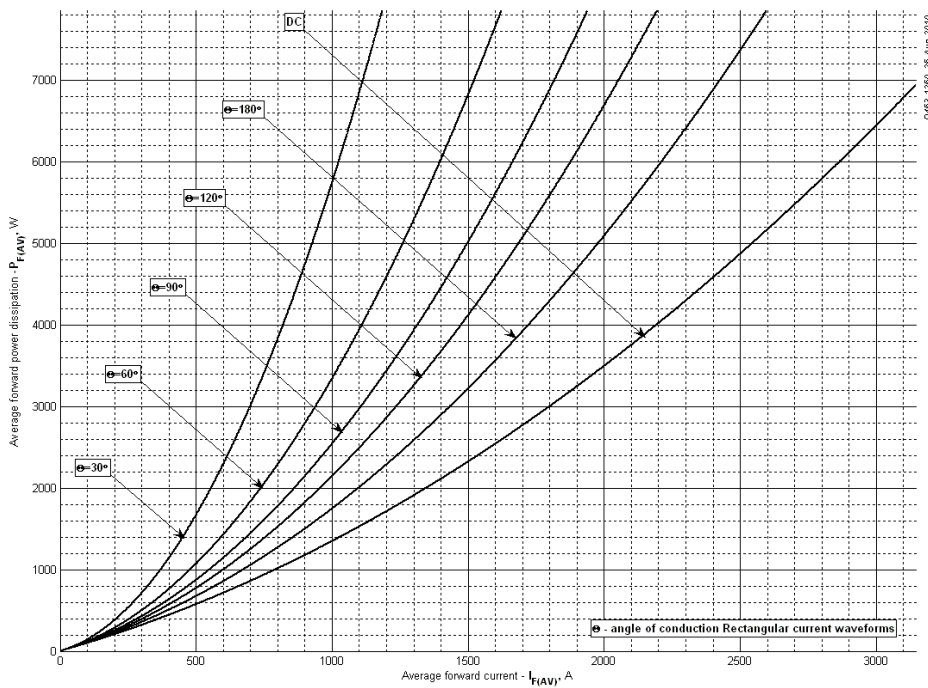

Fig 6 - Recovery time, t_r (50% chord)



D453-1250-25-Aug-2010

Fig 7 - Mean forward power dissipation P_{FAV} vs. Mean forward current I_{FAV} for sinusoidal current waveforms at different conduction angles ($f=50\text{Hz}$, DSC)



D453-1250-25-Aug-2010

Fig 8 – Mean forward power dissipation P_{FAV} vs. Mean forward current I_{FAV} for rectangular current waveforms at different conduction angles and for DC ($f=50\text{Hz}$, DSC)

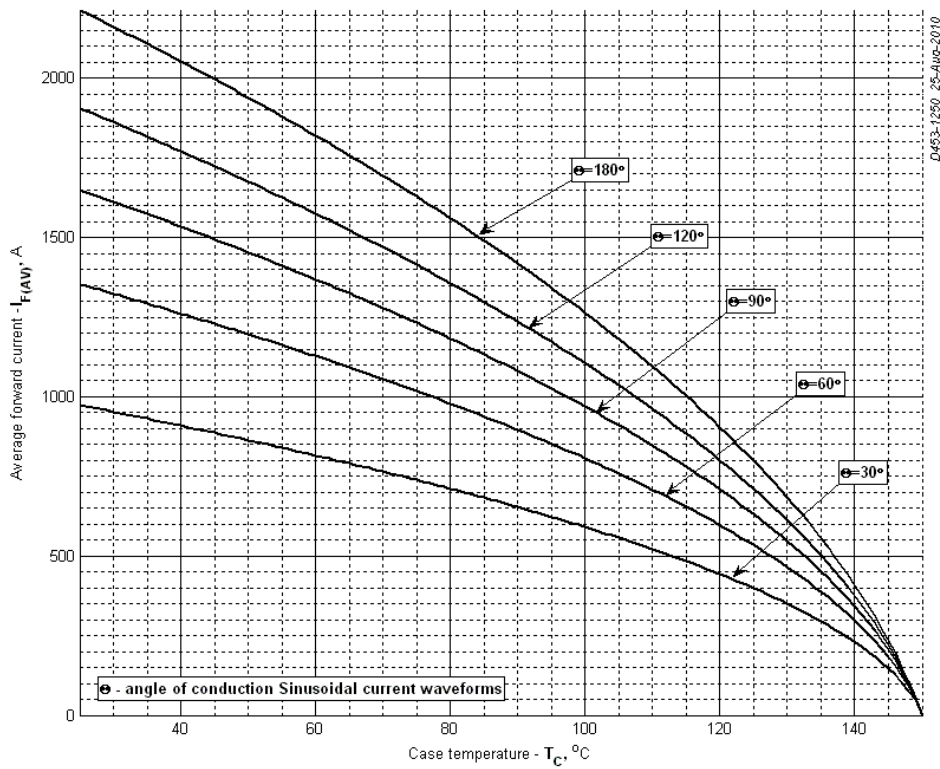

D453-1250 25-Aug-2010

Fig 9 – Mean forward current I_{FAV} vs. Case temperature T_C for sinusoidal current waveforms at different conduction angles ($f=50\text{Hz}$, DSC)

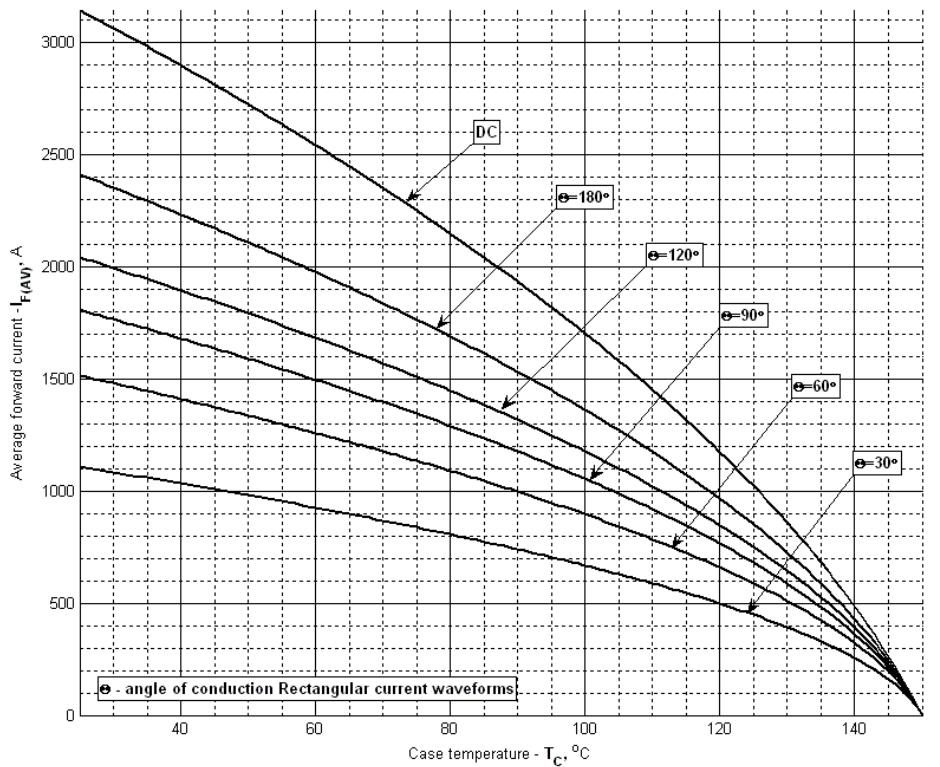

D453-1250 25-Aug-2010

Fig 10 - Mean forward current I_{FAV} vs. Case temperature T_C for rectangular current waveforms at different conduction angles and for DC ($f=50\text{Hz}$, DSC)

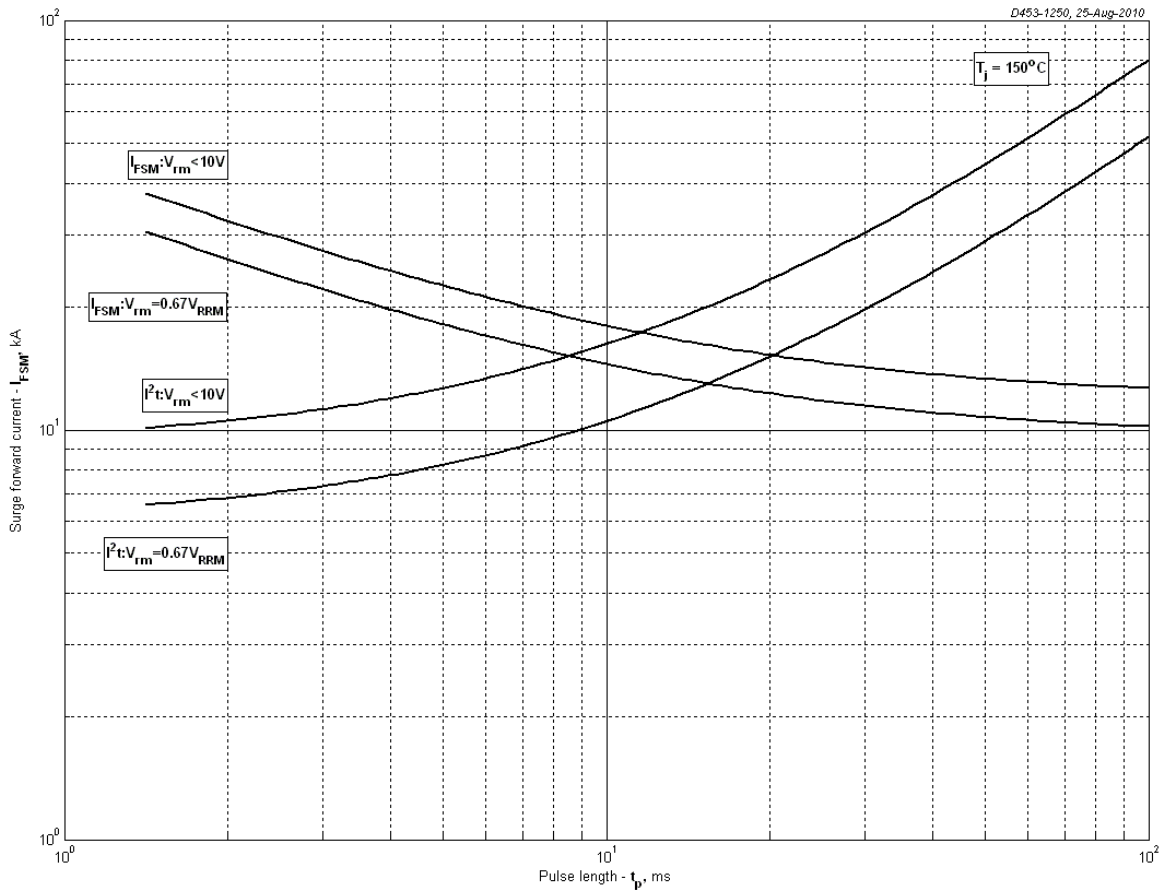

Fig 11 – Maximum surge and I^2t ratings

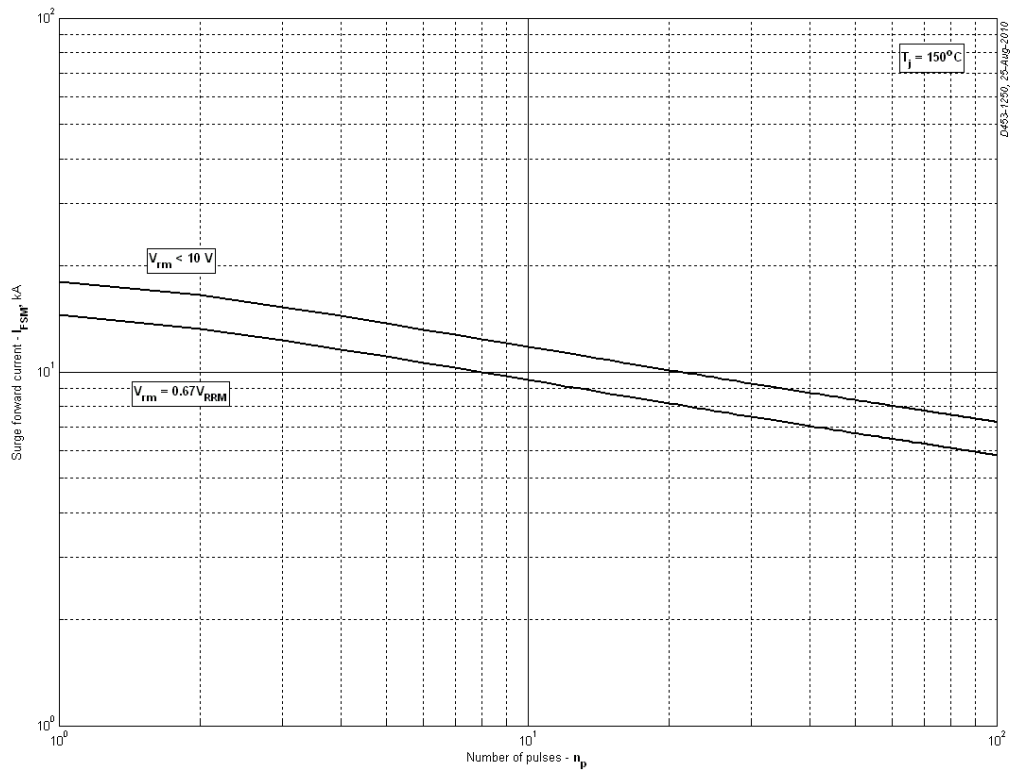

Fig 12 - Maximum surge ratings