

Electrically isolated base plate
 Industrial standard package
 Simplified mechanical design, rapid assembly
 Pressure contact

Single Thyristor Module For Phase Control MT1-700-12-B0

Mean on-state current		I_{TAV}	700 A
Repetitive peak off-state voltage		V_{DRM}	1000...1200 V
Repetitive peak reverse voltage		V_{RRM}	
Turn-off time		t_q	160, 200, 250, 320, 400, 500 μs
V_{DRM}, V_{RRM}, V	1000	1100	1200
Voltage code	10	11	12
$T_j, ^\circ C$	-40...+140		

MT1

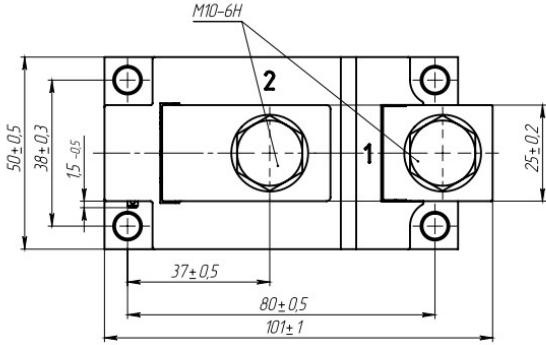
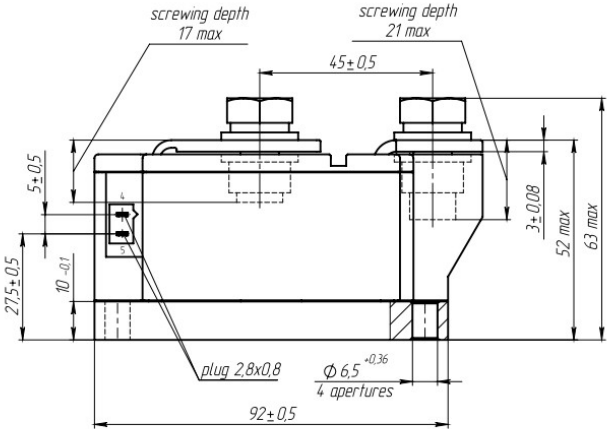
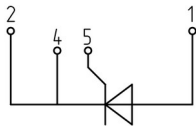

All dimensions in millimeters (inches)

MAXIMUM ALLOWABLE RATINGS

Symbols and parameters		Units	Values	Test conditions
ON-STATE				
I_{TAV}	Maximum allowable mean on-state current	A	700 719	$T_c=87\text{ }^\circ\text{C}$; $T_c=85\text{ }^\circ\text{C}$; 180° half-sine wave; 50 Hz
I_{TRMS}	RMS on-state current	A	1099	$T_c=87\text{ }^\circ\text{C}$; 180° half-sine wave; 50 Hz
I_{TSM}	Surge on-state current	kA	17.5 20.0	$T_j=T_{j\text{ max}}$ $T_j=25\text{ }^\circ\text{C}$ 180° half-sine wave; $t_p=10\text{ ms}$; single pulse; $V_D=V_R=0\text{ V}$; Gate pulse: $I_G=2\text{ A}$; $t_{GP}=50\text{ }\mu\text{s}$; $di_G/dt\geq 1\text{ A}/\mu\text{s}$
			18.0 21.0	$T_j=T_{j\text{ max}}$ $T_j=25\text{ }^\circ\text{C}$ 180° half-sine wave; $t_p=8.3\text{ ms}$; single pulse; $V_D=V_R=0\text{ V}$; Gate pulse: $I_G=2\text{ A}$; $t_{GP}=50\text{ }\mu\text{s}$; $di_G/dt\geq 1\text{ A}/\mu\text{s}$
I^2t	Safety factor	$\text{A}^2\text{s}\cdot 10^3$	1500 2000	$T_j=T_{j\text{ max}}$ $T_j=25\text{ }^\circ\text{C}$ 180° half-sine wave; $t_p=10\text{ ms}$; single pulse; $V_D=V_R=0\text{ V}$; Gate pulse: $I_G=2\text{ A}$; $t_{GP}=50\text{ }\mu\text{s}$; $di_G/dt\geq 1\text{ A}/\mu\text{s}$
			1300 1800	$T_j=T_{j\text{ max}}$ $T_j=25\text{ }^\circ\text{C}$ 180° half-sine wave; $t_p=8.3\text{ ms}$; single pulse; $V_D=V_R=0\text{ V}$; Gate pulse: $I_G=2\text{ A}$; $t_{GP}=50\text{ }\mu\text{s}$; $di_G/dt\geq 1\text{ A}/\mu\text{s}$
BLOCKING				
V_{DRM}, V_{RRM}	Repetitive peak off-state and Repetitive peak reverse voltages	V	1000...1200	$T_{j\text{ min}} < T_j < T_{j\text{ max}}$; 180° half-sine wave; 50 Hz; Gate open
V_{DSM}, V_{RSM}	Non-repetitive peak off-state and Non-repetitive peak reverse voltages	V	1100...1300	$T_{j\text{ min}} < T_j < T_{j\text{ max}}$; 180° half-sine wave; single pulse; Gate open
V_D, V_R	Direct off-state and Direct reverse voltages	V	$0.6\cdot V_{DRM}$ $0.6\cdot V_{RRM}$	$T_j=T_{j\text{ max}}$; Gate open
TRIGGERING				
I_{FGM}	Peak forward gate current	A	8	$T_j=T_{j\text{ max}}$
V_{RGM}	Peak reverse gate voltage	V	5	
P_G	Gate power dissipation	W	4	$T_j=T_{j\text{ max}}$ for DC gate current
SWITCHING				
$(di_T/dt)_{\text{crit}}$	Critical rate of rise of on-state current non-repetitive ($f=1\text{ Hz}$)	$\text{A}/\mu\text{s}$	600	$T_j=T_{j\text{ max}}$; $V_D=0.67\cdot V_{DRM}$; $I_{TM}=3100\text{ A}$; Gate pulse: $I_G=2\text{ A}$; $t_{GP}=50\text{ }\mu\text{s}$; $di_G/dt\geq 2\text{ A}/\mu\text{s}$
THERMAL				
T_{stg}	Storage temperature	$^\circ\text{C}$	-40...+50	
T_j	Operating junction temperature	$^\circ\text{C}$	-40...+140	
$T_{c\text{ op}}$	Operating temperature	$^\circ\text{C}$	-40...+125	
MECHANICAL				
a	Acceleration under vibration	m/s^2	50	

CHARACTERISTICS

Symbols and parameters		Units	Values	Conditions	
ON-STATE					
V_{TM}	Peak on-state voltage, max	V	1.50	$T_j=25\text{ }^\circ\text{C}; I_{TM}=2198\text{ A}$	
$V_{T(TO)}$	On-state threshold voltage, max	V	0.867	$T_j=T_{j\text{ max}};$	
r_T	On-state slope resistance, max	m Ω	0.296	$0.5\pi I_{TAV} < I_T < 1.5\pi I_{TAV}$	
I_L	Latching current, max	mA	1000	$T_j=25\text{ }^\circ\text{C}; V_D=12\text{ V};$ Gate pulse: $I_G=2\text{ A};$ $t_{GP}=50\text{ }\mu\text{s}; di_G/dt\geq 1\text{ A}/\mu\text{s}$	
I_H	Holding current, max	mA	300	$T_j=25\text{ }^\circ\text{C};$ $V_D=12\text{ V};$ Gate open	
BLOCKING					
I_{DRM}, I_{RRM}	Repetitive peak off-state and Repetitive peak reverse currents, max	mA	70 3.00	$T_j=T_{j\text{ max}}$ $T_j=25\text{ }^\circ\text{C}$	$V_D=V_{DRM}; V_R=V_{RRM}$
$(dv_D/dt)_{crit}$	Critical rate of rise of off-state voltage ¹⁾ , min	V/ μs	200, 320, 500, 1000, 1600, 2000, 2500	$T_j=T_{j\text{ max}};$ $V_D=0.67\cdot V_{DRM};$ Gate open	
TRIGGERING					
V_{GT}	Gate trigger direct voltage, max	V	3.00 2.50 2.00	$T_j= T_{j\text{ min}}$ $T_j=25\text{ }^\circ\text{C}$ $T_j= T_{j\text{ max}}$	$V_D=12\text{ V}; I_D=3\text{ A};$ Direct gate current
I_{GT}	Gate trigger direct current, max	mA	400 250 200	$T_j= T_{j\text{ min}}$ $T_j= 25\text{ }^\circ\text{C}$ $T_j= T_{j\text{ max}}$	
V_{GD}	Gate non-trigger direct voltage, min	V	0.30	$T_j=T_{j\text{ max}};$ $V_D=0.67\cdot V_{DRM};$	
I_{GD}	Gate non-trigger direct current, min	mA	35.00	Direct gate current	
SWITCHING					
t_{gd}	Delay time, max	μs	0.80	$T_j=25\text{ }^\circ\text{C}; V_D=600\text{ V}; I_{TM}=I_{TAV};$ $di/dt=200\text{ A}/\mu\text{s};$	
t_{gt}	Turn-on time, max	μs	2.00	Gate pulse: $I_G=2\text{ A}; V_G=20\text{ V};$ $t_{GP}=50\text{ }\mu\text{s}; di_G/dt=2\text{ A}/\mu\text{s}$	
t_q	Turn-off time ²⁾ , max	μs	160, 200, 250, 320, 400, 500	$dv_D/dt=50\text{ V}/\mu\text{s}; T_j=T_{j\text{ max}}; I_{TM}= I_{TAV};$ $di_R/dt=10\text{ A}/\mu\text{s}; V_R=100\text{V};$ $V_D=0.67 V_{DRM};$	
Q_{rr}	Total recovered charge, max	μC	1140	$T_j= T_{j\text{ max}}; I_{TM}=700\text{ A};$	
t_{rr}	Reverse recovery time, max	μs	19	$di_R/dt=-10\text{ A}/\mu\text{s};$	
I_{rr}	Reverse recovery current, max	A	120	$V_R=100\text{ V}$	
THERMAL					
R_{thjc}	Thermal resistance, junction to case			180° half-sine wave, 50 Hz	
	per module	$^\circ\text{C}/\text{W}$	0.0550		
R_{thch}	Thermal resistance, case to heatsink				
	per module	$^\circ\text{C}/\text{W}$	0.0100		
INSULATION					
V_{ISOL}	Insulation test voltage	kV	3.00	Sine wave, 50 Hz;	$t=1\text{ min}$
			3.60	RMS	$t=1\text{ sec}$
MECHANICAL					
M_1	Mounting torque (M6) ³⁾	Nm	6.00	Tolerance $\pm 15\%$	
M_2	Terminal connection torque (M10) ³⁾	Nm	12.00	Tolerance $\pm 15\%$	
m	Weight, max	g	900		

PART NUMBERING GUIDE

MT	1	-	700	-	12	-	A2	E2	-	B0	-	N
1	2		3		4		5	6		7		8

1. Thyristor module (MT)
2. Circuit Schematic
3. Average On-state Current, A
4. Voltage Code
5. Critical rate of rise of off-state voltage
6. Group of turn-off time ($dv_D/dt=50 \text{ V}/\mu\text{s}$)
7. Package Type (M.B0)
8. Ambient Conditions:
N – Normal

NOTES

¹⁾ Critical rate of rise of off-state voltage

Symbol of Group	P2	K2	E2	A2	T1	P1	M1
$(dv_D/dt)_{crit}, \text{ V}/\mu\text{s}$	200	320	500	1000	1600	2000	2500

²⁾ Turn-off time ($dv_D/dt=50 \text{ V}/\mu\text{s}$)

Symbol of Group	T2	P2	M2	K2	H2	E2
$t_{qr}, \mu\text{s}$	160	200	250	320	400	500

³⁾ The screws must be lubricated

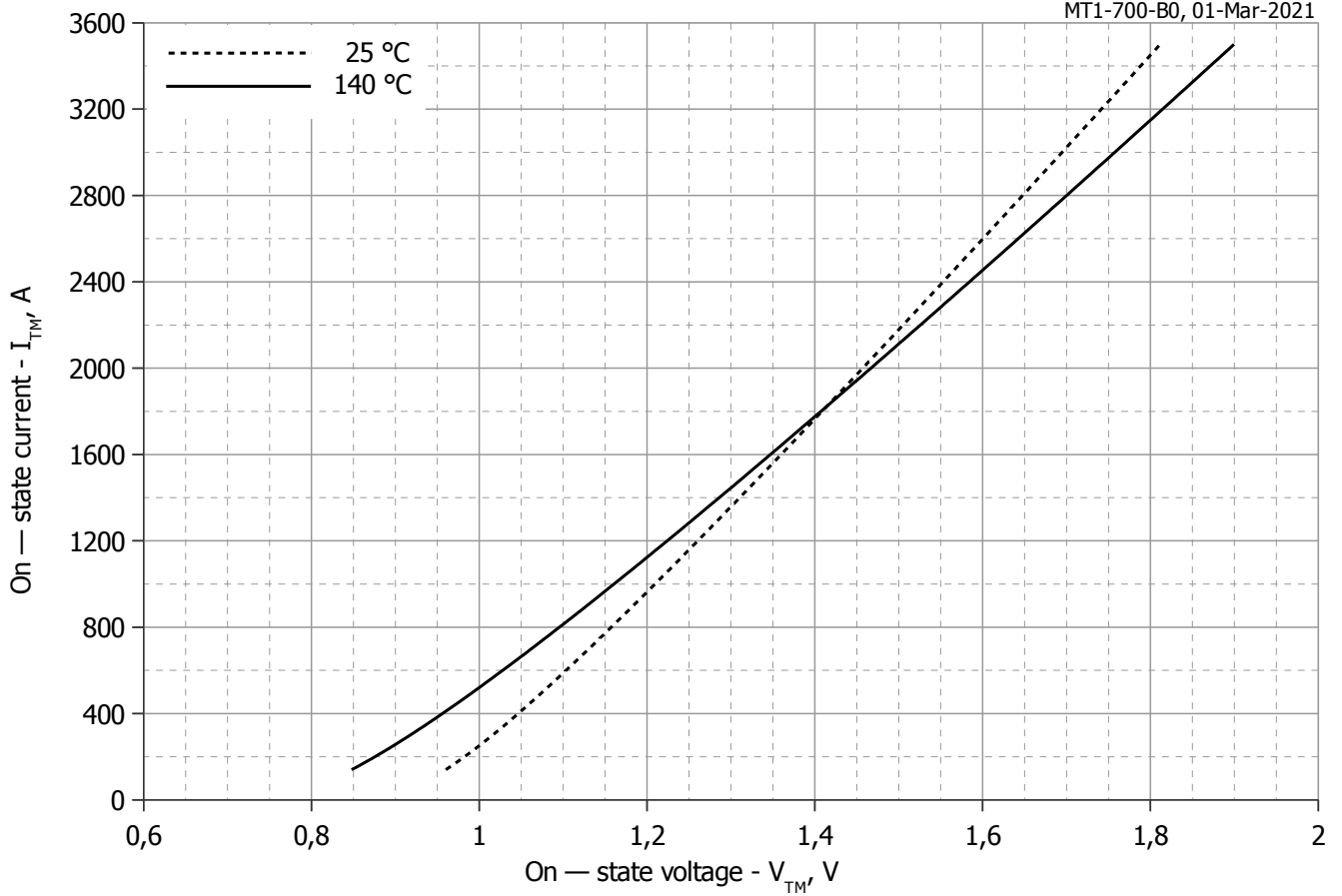

Fig 1 – On-state characteristics of Limit device

Analytical function for On-state characteristic:

$$V_T = A + B \cdot i_T + C \cdot \ln(i_T + 1) + D \cdot \sqrt{i_T}$$

	Coefficients for max curves	
	$T_j = 25^\circ\text{C}$	$T_j = T_{j,max}$
A	0.83278087	0.71139484
B	0.00021302	0.00024525
C	0.01533458	0.01088184
D	0.00182620	0.00407337

On-state characteristic model (see Fig. 1)

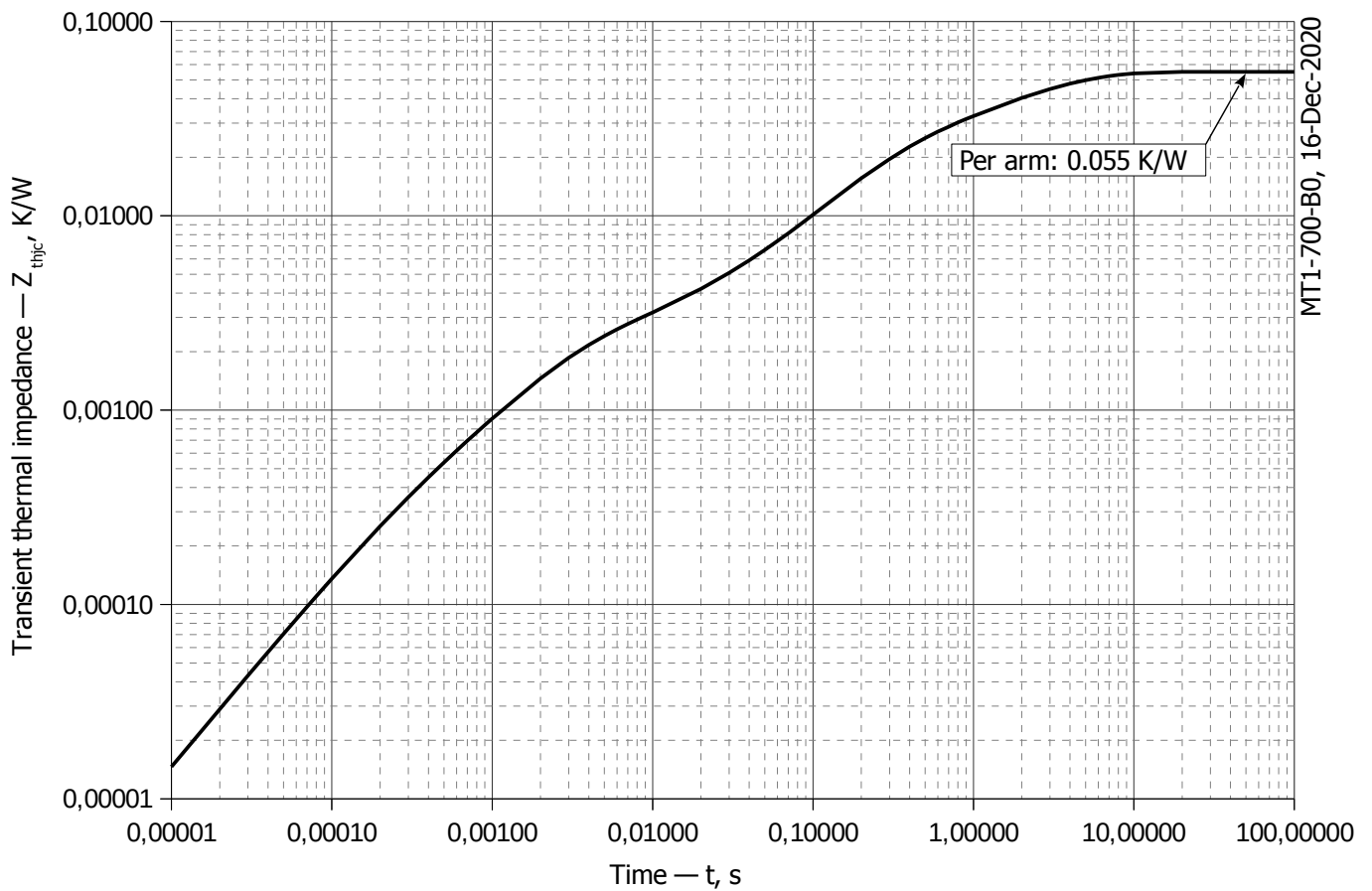

Fig 2 – Transient thermal impedance Z_{thjc} vs. time t

Analytical function for Transient thermal impedance junction to case Z_{thjc} for DC:

$$Z_{thjc} = \sum_{i=1}^n R_i \left(1 - e^{-\frac{t}{\tau_i}} \right)$$

Where $i = 1$ to n , n is the number of terms in the series.

t = Duration of heating pulse in seconds.

Z_{thjc} = Thermal resistance at time t .

R_i = Amplitude of p_{th} term.

τ_i = Time constant of r_{th} term.

i	1	2	3	4	5	6
R_i K/W	0.0249	0.0112	0.01635	0.0006528	0.001791	0.0001363
τ_i s	3.132	1.000	0.2335	0.01038	0.002348	0.0002448

Transient thermal impedance junction to case Z_{thjc} model (see Fig. 2)

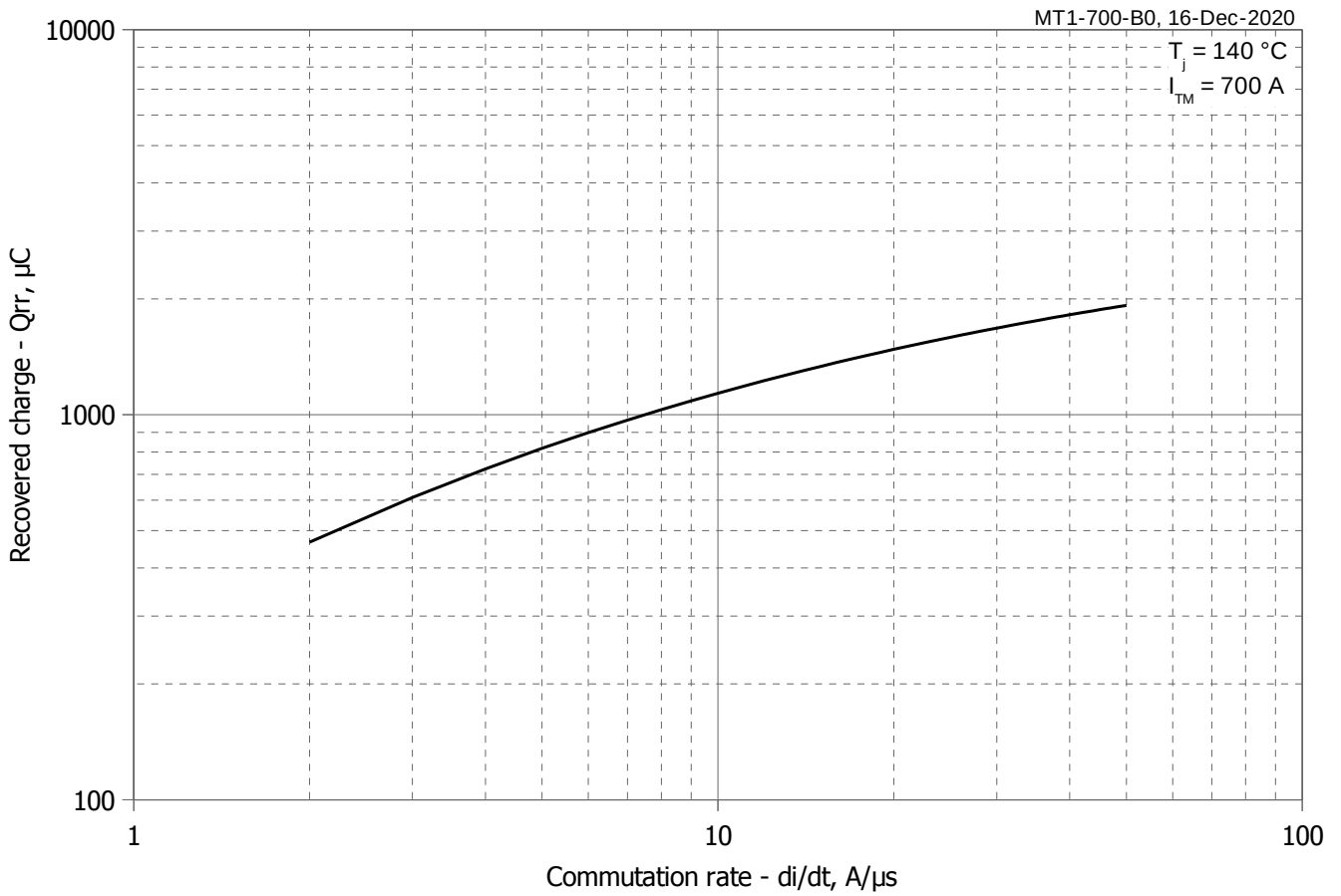

Fig 3 – Maximum recovered charge Q_{rr} vs. commutation rate di_R/dt (25% chord)

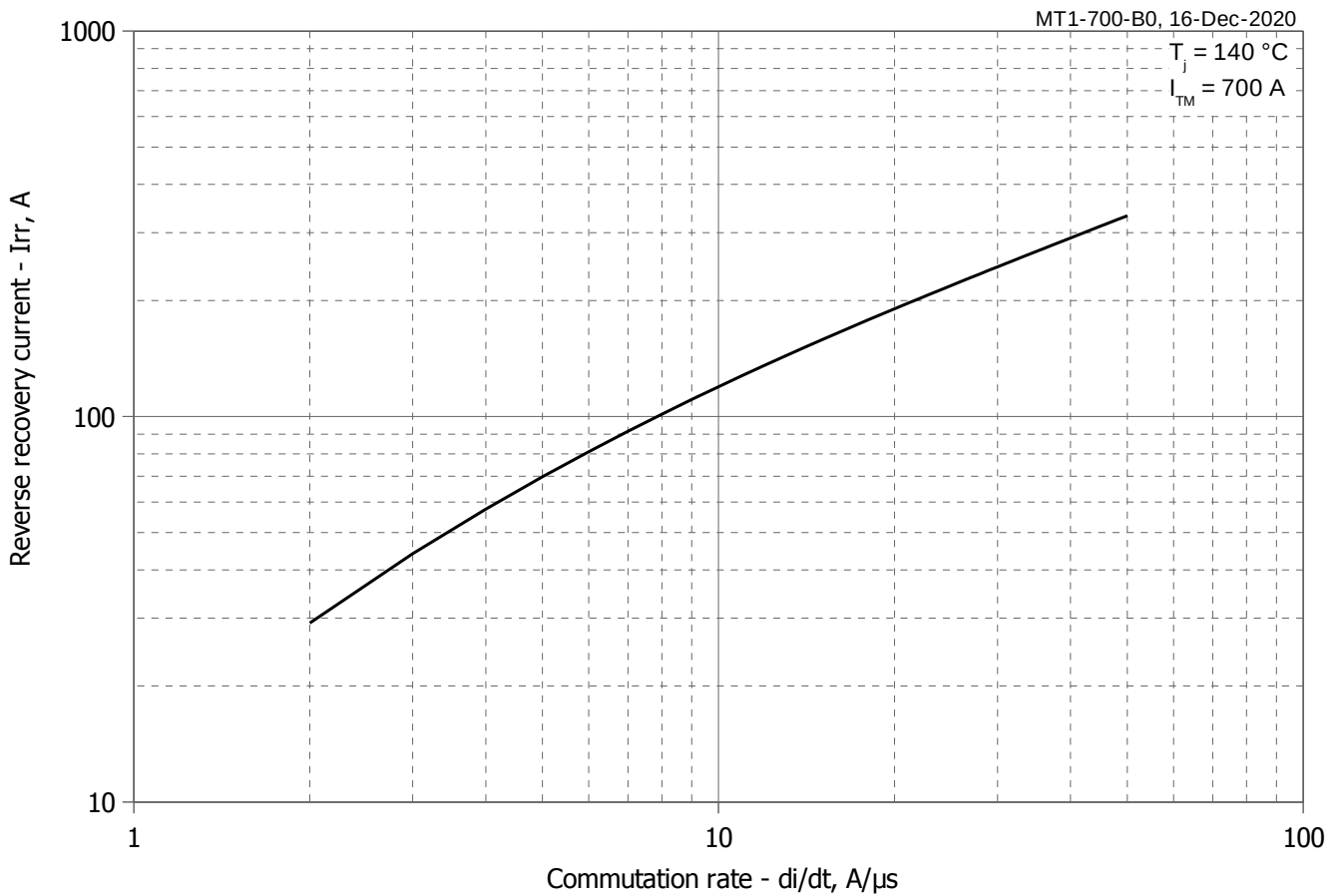

Fig 4 – Maximum reverse recovery current I_{rr} vs. commutation rate di_R/dt

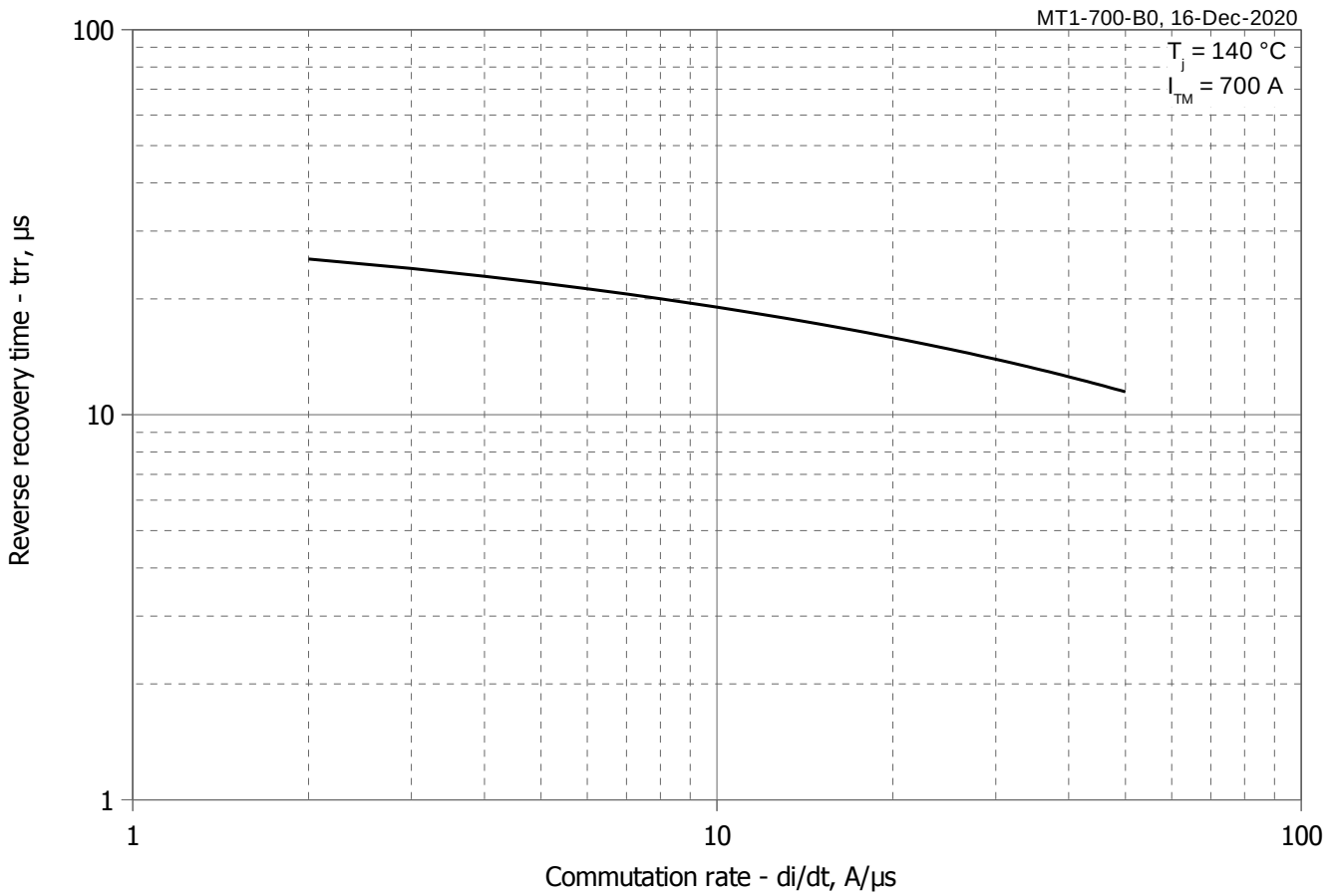

Fig 5 – Maximum recovery time t_{rr} vs. commutation rate di_R/dt (25% chord)

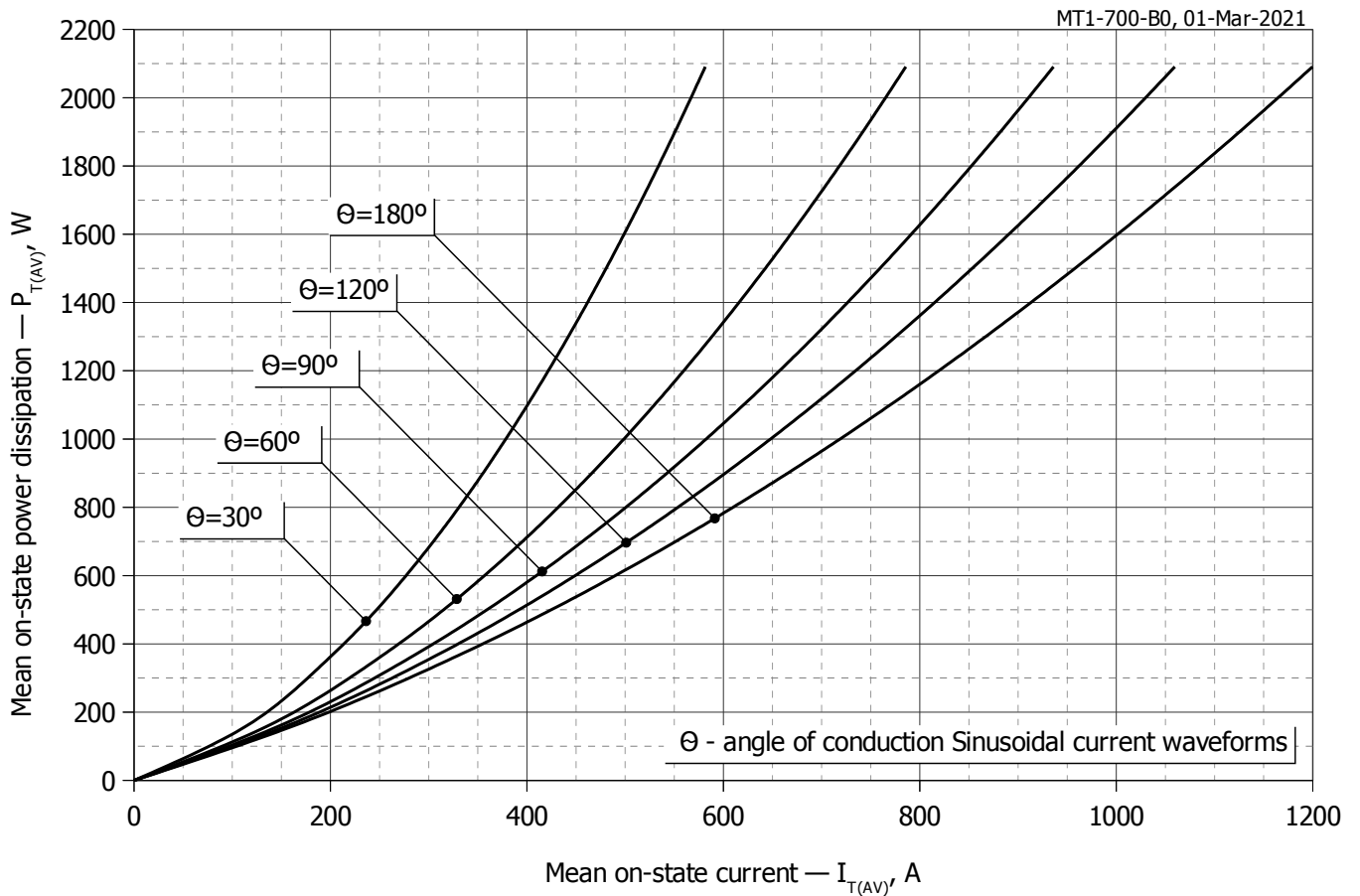

Fig. 6 - Mean on-state power dissipation P_{TAV} vs. mean on-state current I_{TAV} for sinusoidal current waveforms at different conduction angles ($f=50\text{Hz}$, DSC)

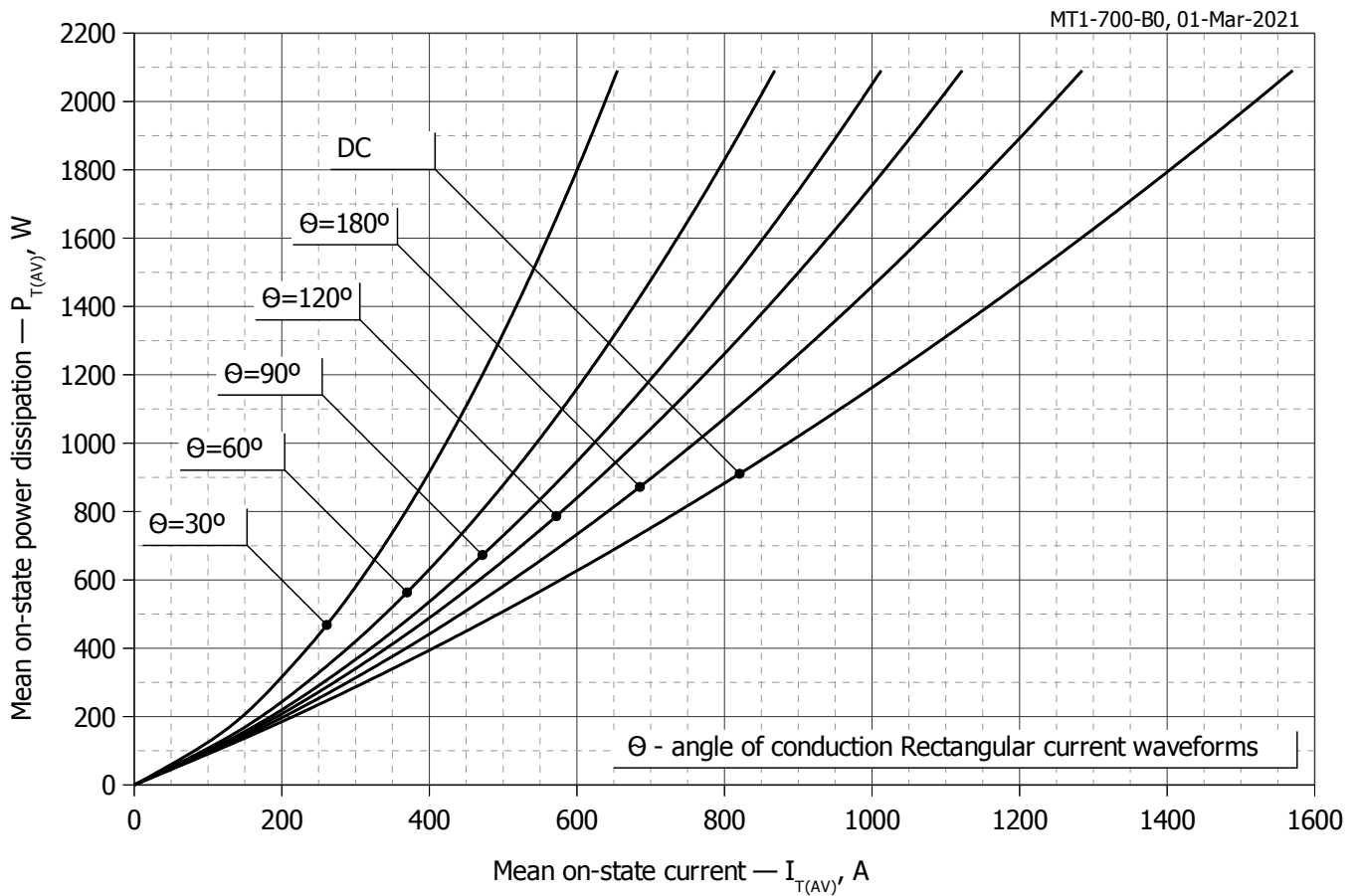

Fig. 7 – Mean on-state power dissipation P_{TAV} vs. mean on-state current I_{TAV} for rectangular current waveforms at different conduction angles and for DC (f=50Hz, DSC)

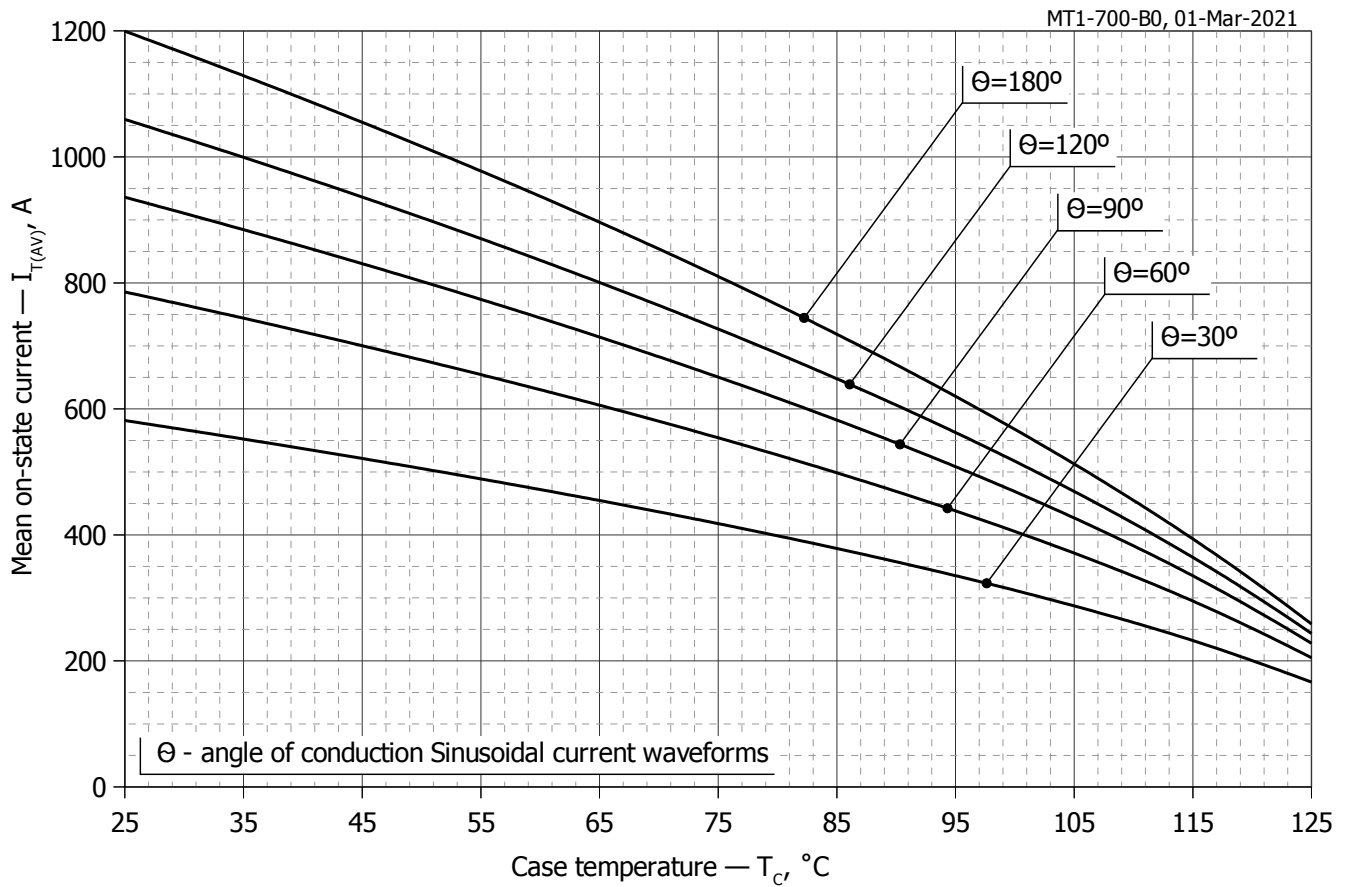

Fig. 8 – Mean on-state current I_{TAV} vs. case temperature T_c for sinusoidal current waveforms at different conduction angles (f=50Hz, DSC)

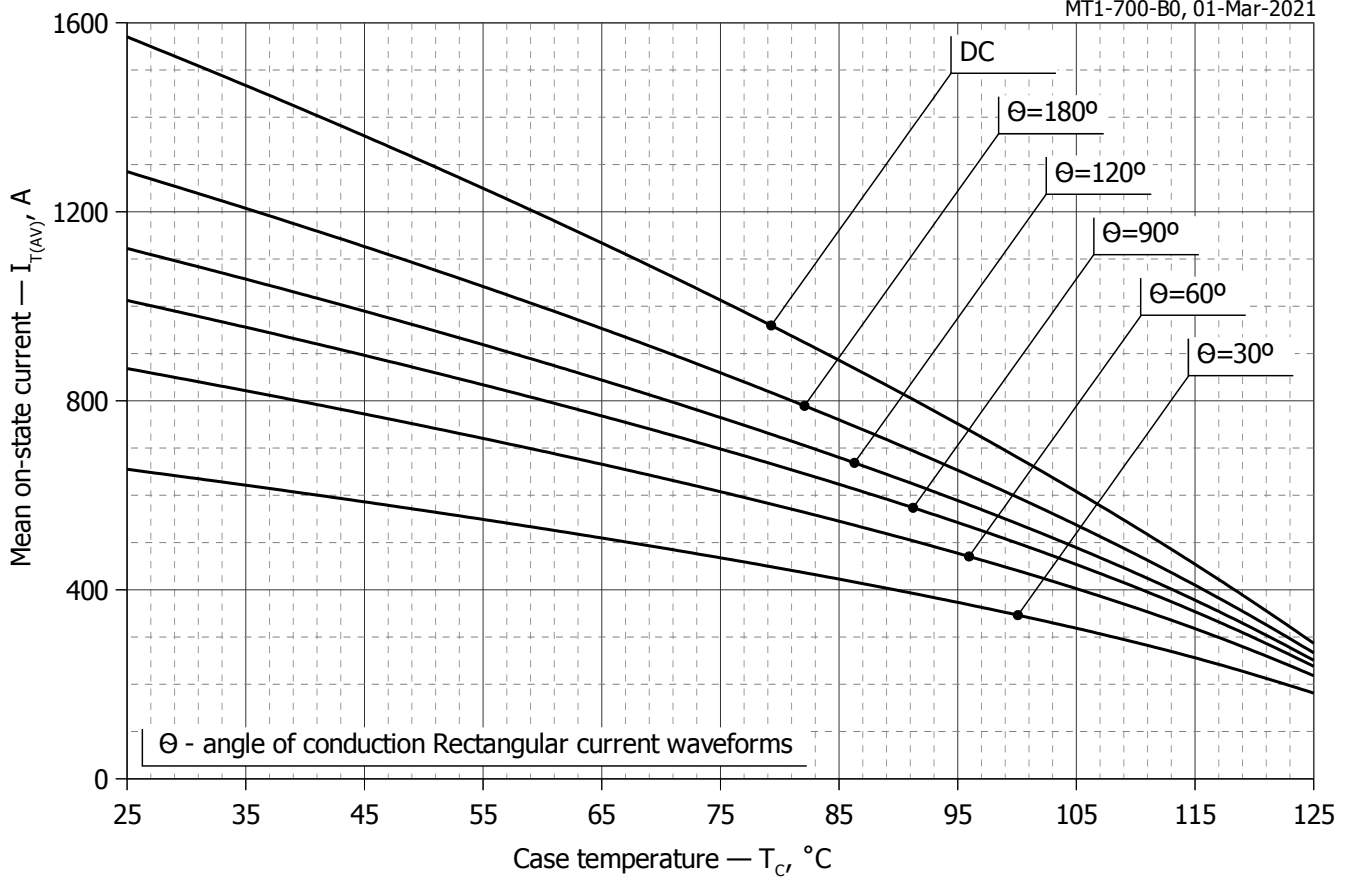

Fig. 9 - Mean on-state current I_{TAV} vs. case temperature T_C for rectangular current waveforms at different conduction angles and for DC (f=50Hz, DSC)

$T_j = 140$ °C

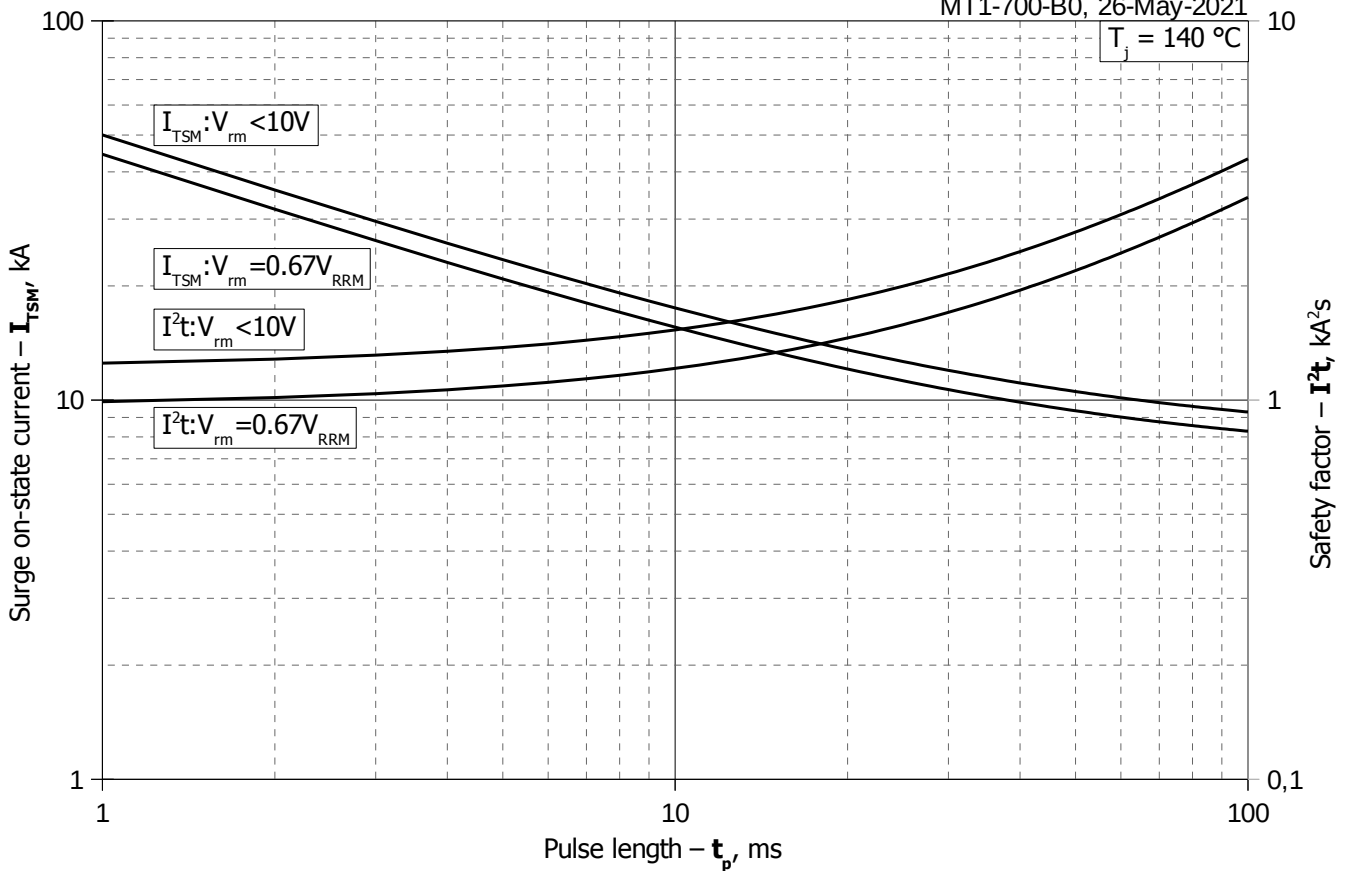
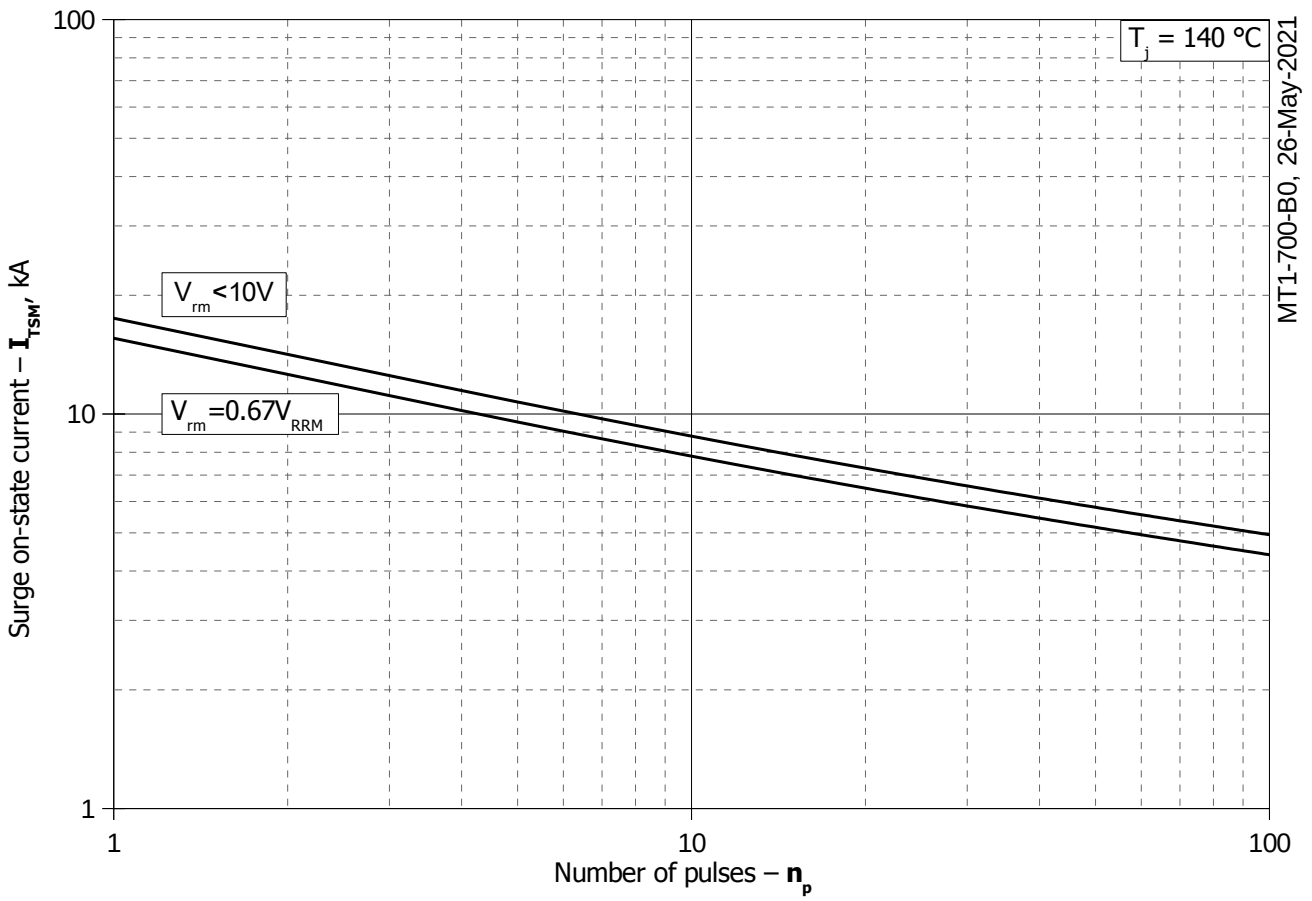

Fig. 10 – Maximum surge on-state current I_{TSM} and safety factor I^2t vs. pulse length t_p



MT1-700-B0, 26-May-2021

Fig. 11 - Maximum surge on-state current I_{TSM} vs. number of pulses n_p